



BEILSTEIN JOURNAL OF ORGANIC CHEMISTRY

Organo-fluorine chemistry III

Edited by David O'Hagan

Imprint

Beilstein Journal of Organic Chemistry
www.bjoc.org
ISSN 1860-5397
Email: journals-support@beilstein-institut.de

The *Beilstein Journal of Organic Chemistry* is published by the Beilstein-Institut zur Förderung der Chemischen Wissenschaften.

Beilstein-Institut zur Förderung der
Chemischen Wissenschaften
Trakehner Straße 7–9
60487 Frankfurt am Main
Germany
www.beilstein-institut.de

The copyright to this document as a whole, which is published in the *Beilstein Journal of Organic Chemistry*, is held by the Beilstein-Institut zur Förderung der Chemischen Wissenschaften. The copyright to the individual articles in this document is held by the respective authors, subject to a Creative Commons Attribution license.

Organo-fluorine chemistry III

David O'Hagan

Editorial

Open Access

Address:
School of Chemistry, University of St Andrews, Fife, KY16 9ST,
United Kingdom

Email:
David O'Hagan - do1@st-andrews.ac.uk

Keywords:
organo-fluorine

Beilstein J. Org. Chem. **2013**, *9*, 2180–2181.
doi:10.3762/bjoc.9.255

Received: 02 September 2013
Accepted: 11 September 2013
Published: 23 October 2013

This article is part of the Thematic Series "Organo-fluorine chemistry III".

Guest Editor: D. O'Hagan

© 2013 O'Hagan; licensee Beilstein-Institut.
License and terms: see end of document.

It is a pleasure to introduce the 3rd in the series of Thematic Issues on organo-fluorine chemistry for the Beilstein Journal of Organic Chemistry (BJOC). These series have become progressively more successful over time in terms of the number and quality of the contributions received. It is also pleasing to note that the profile and impact factor of the journal has increased steadily over this time as well.

Organo-fluorine chemistry is enjoying a high profile at present, particularly in methodology development. There has been considerable success across the international community in the development of organometallic methods for the incorporation of fluorinated substituents onto aryl and heterocyclic rings. Such motifs are required by the pharmaceutical and agrochemical industries to modulate the performance and pharmacokinetics of bioactives. The particular challenge of delivering direct and efficient methods for C–F, C–R_f or C–XR_f bond formation has been a major focus in the last few years and landmark developments have been made. Many of the contributions in the Thematic Series focus on this aspect of organo-fluorine chemistry.

Fluorine touches all categories of performance compounds extending from bioactives to organic materials, and society demands continual improvements in the quality and perform-

ance of products and devices. As the global population steadily increases the pressure to improve health care and agricultural yields, is immense. This requires innovation in molecular design, and because of its particular ability to tune properties, fluorine chemistry may provide the means. To meet these demands we continually need new methods and new building blocks to prepare new classes of compounds. As our ability to prepare and apply organo-fluorine molecules improves, it demands a deeper understanding of their properties and behaviour. The papers of the Thematic Series touch on all of these aspects and the area remains as innovative and relevant as ever.

I have to thank all of the authors who have taken the time to prepare manuscripts, and to offer their latest scientific contributions to this Thematic Series. The quality of the papers and the geographical distribution of the contributing laboratories is a clear indication of the health, vitality and importance of fluorine chemistry as a specialism within the wider chemical enterprise.

David O'Hagan

St Andrews, September 2013

License and Terms

This is an Open Access article under the terms of the Creative Commons Attribution License (<http://creativecommons.org/licenses/by/2.0>), which permits unrestricted use, distribution, and reproduction in any medium, provided the original work is properly cited.

The license is subject to the *Beilstein Journal of Organic Chemistry* terms and conditions: (<http://www.beilstein-journals.org/bjoc>)

The definitive version of this article is the electronic one which can be found at:
[doi:10.3762/bjoc.9.255](https://doi.org/10.3762/bjoc.9.255)

Synthesis of enones, pyrazolines and pyrrolines with *gem*-difluoroalkyl side chains

Assaad Nasr El Dine^{1,2}, Ali Khalaf^{1,2}, Danielle Grée¹, Olivier Tasseau¹, Fares Fares², Nada Jaber², Philippe Lesot³, Ali Hachem^{*2} and René Grée^{*1}

Letter

Open Access

Address:

¹Université de Rennes 1, Institut des Sciences Chimiques de Rennes, CNRS UMR 6226, Avenue du Général Leclerc, 35042 Rennes Cedex, France, ²Laboratory for Medicinal Chemistry and Natural Products, Lebanese University, Faculty of Sciences (1) and PRASE-EDST, Hadath, Beyrouth, Lebanon and ³RMN en Milieu Orienté, ICMMO, CNRS UMR 8182, Université de Paris Sud, 91405 Orsay cedex, France

Email:

Ali Hachem^{*} - ahachem@ul.edu.lb; René Grée^{*} - rene.gree@univ-rennes1.fr

* Corresponding author

Keywords:

¹⁹F/¹H HOESY; *gem*-difluoroalkyl derivatives; organo-fluorine compounds; palladium catalysis; pyrazolines; pyrrolines

Beilstein J. Org. Chem. 2013, 9, 1943–1948.

doi:10.3762/bjoc.9.230

Received: 03 July 2013

Accepted: 06 September 2013

Published: 26 September 2013

This article is part of the Thematic Series "Organo-fluorine chemistry III".

Guest Editor: D. O'Hagan

© 2013 El Dine et al; licensee Beilstein-Institut.

License and terms: see end of document.

Abstract

Starting from easily accessible *gem*-difluoropropargylic derivatives, a DBU-mediated isomerisation affords enones in fair yields with a *gem*-difluoroalkyl chain. These derivatives were used to prepare pyrazolines and pyrrolines with the desired *gem*-difluoroalkyl side chain by cyclocondensations in good yields and with excellent stereoselectivity. A one-pot process was also successfully developed for these sequential reactions. By carrying out various types of Pd-catalyzed coupling reactions for compounds with a *p*-bromophenyl substituent a route to focused chemical libraries was demonstrated.

Introduction

A widely used strategy in bioorganic, medicinal chemistry and in chemical biology is the selected introduction of fluorine in organic molecules since it strongly modifies their properties [1-9]. On the other hand, heterocyclic molecules – in particular, the so-called privileged scaffolds – are introduced very classically in the core of pharmaceutical products [10,11]. Therefore, it appears to be of much interest to design novel methodologies

for the preparation of new fluorinated heterocyclic molecules. We developed a programme to investigate the preparation and uses of new propargylic fluorides [12-14], which have been employed in the synthesis of fluorinated analogues of lipids [15,16] and in carbocyclic systems [17,18]. They have also been used for the preparation of several 5 and 6-membered heterocycles [19-22]. The goal of the present work is to demonstrate

that selected propargylic derivatives [23–25] can be employed for the preparation of enones with a *gem*-difluoroalkyl chain by using an isomerisation process (Scheme 1).

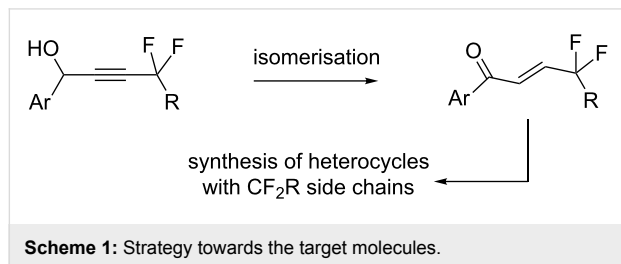

These intermediates can be employed for the preparation of representative 5-membered heterocyclic systems with CF₂R side chains by using cyclocondensation reactions. Furthermore, selected molecules in these series were functionalized by using appropriate palladium-catalyzed coupling reactions en route to chemical libraries.

Results and Discussion

The first example of a base-mediated isomerisation process for an alkyne activated by an ester group was reported by Nineham and Raphael in 1949 [26]. Later, extension to other electrophilic alkynes was demonstrated by Sonye and Koide [27]. Recently, it has been established by Yamazaki's group that propargylic alcohols bearing a CF₃ group on the triple bond could be isomerised to the corresponding enones. In that case, Et₃N proved to be sufficient as a catalyst to perform this transformation [28].

The required starting propargylic alcohols were obtained by a reaction of the lithium salt of easily available *gem*-difluoro propargylic derivative **1** [18] with aromatic aldehydes, affording compounds **2a–2e** in 71–82% yields (Scheme 2 and Table 1). With these *gem*-difluoro intermediates, Et₃N was not an efficient catalyst since only a low conversion was observed and the reaction was not clean. On the contrary, the DBU-mediated isomerisation was successful, affording the desired enones **3a–3e** in 60–63% yields. The selectivity was excellent since in all cases the *E*-isomer was obtained almost exclusively (>98%). Similar reactions were carried out with propargylic derivatives bearing alkyl groups instead of the (Ar) aromatic or heteroaromatic group, but these reactions were not successful. Therefore, this reaction appears limited to derivatives with aryl or heteroaryl substituents as in the case of the CF₃-substituted propargylic derivatives [28].

Next, we turned towards the preparation of heterocyclic structures from enones **3**. Pyrazolines are well-recognized heterocyclic cores for pharmacologically active molecules [29].

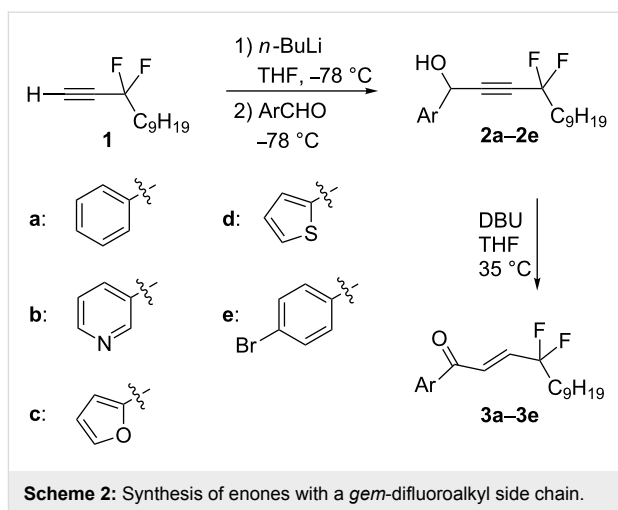
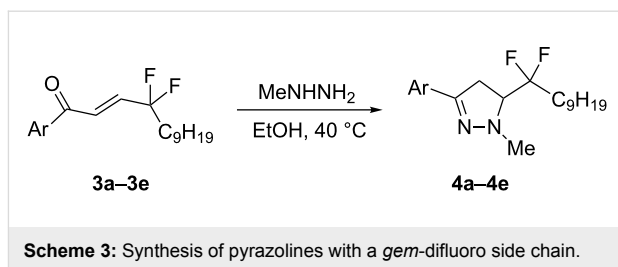

Table 1: Synthesis of enones **3a–3e**.

Entry	Ar	Step 1 Yield (%)	Step 2 Yield (%)
1	Ph	2a (82)	3a (62)
2	C ₅ H ₄ N	2b (78)	3b (62)
3	C ₄ H ₃ O	2c (79)	3c (63)
4	C ₄ H ₃ S	2d (71)	3d (60)
5	<i>p</i> -PhBr	2e (81)	3e (61)

Therefore, they were selected as first examples of 5-membered heterocyclic targets with the fluorinated side chain. Reaction of **3a–3e** with methylhydrazine gave the desired pyrazolines **4a–4e** in 79–86% yields (Scheme 3).

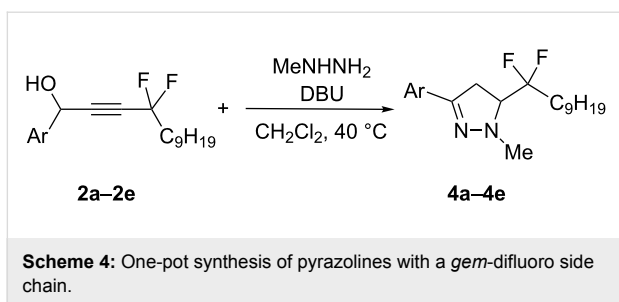

It appeared that the reaction conditions for the synthesis of these pyrazolines were compatible with the first isomerisation step, therefore the possibility of a "one-pot" reaction was considered. Indeed, by heating a mixture of propargylic alcohols **2a–2e** with DBU (1,8-diazabicycloundec-7-ene) in the presence of methylhydrazine (Scheme 4) the pyrazolines **4a–4e** were obtained after 3–7 h in excellent yields (82–92%, Table 2). This very short and efficient synthesis of pyrazolines **4** can be related to another excellent one-pot reaction with 3-components where the first step is a Pd-catalyzed coupling–isomerisation process followed by a cyclocondensation [30].

**Table 2:** Synthesis of pyrrolines **4a–4e**.

Entry	Ar	Yield (%) (3 to 4)	Yield (%) (1 to 4)
1	Ph	4a (85)	4a (86)
2	C ₅ H ₄ N	4b (79)	4b (82)
3	C ₄ H ₃ O	4c (81)	4c (84)
4	C ₄ H ₃ S	4d (82)	4d (83)
5	<i>p</i> -PhBr	4e (86)	4e (92)

Pyrroline is another noteworthy example of a heterocyclic scaffold useful in bioorganic and medicinal chemistry [31,32]. It is also well-recognized for agrochemicals, especially in combination with CF₃ substituents. Recently, the group of Shibata has developed an elegant organocatalyzed asymmetric approach to such pyrrolines [33]. Moreover, an efficient synthesis of β-trifluoromethylated Δ¹-pyrrolines has been reported [34]. Therefore, we selected pyrrolines with CF₂R side chains as a second example of 5-membered heterocyclic targets. Condensation of the anion of glycine ester diphenylimine **5** with the enones **3a–3e** afforded the desired pyrrolines **6a–6e** (Scheme 4 and Table 3). In all cases good yields were obtained, and a complete selectivity for the *trans*-isomer was observed as established by

NMR analysis of the crude reaction mixtures. This is different from the results obtained by starting from enones with CF₂CF₂X side chains, where *trans/cis* mixtures were reported [34]. The ³J_{HH} (6.3–6.5 Hz, *trans*) of our pyrrolines were very close to those of similar molecules bearing CF₂–CF₃ chains (6.4–6.6 Hz), while for latter derivatives the *cis* coupling constants were larger (≥ 8.3 Hz) [34]. This was confirmed in the case of pyrroline **6a** by performing additional ¹⁹F/¹H hOe 2D experiments which revealed strong correlations between the fluorine atoms of the CF₂ group and the cyclic protons H_c and H_a (see Scheme 5 and 2D spectrum in the Supporting Information File 1 for details).

Table 3: Synthesis of pyrrolines **6a–6e**.

Entry	Ar	Yield (%) (3 to 6)	Yield (%) (1 to 6)
1	Ph	6a (74)	6a (73)
2	C ₅ H ₄ N	6b (73)	6b (76)
3	C ₄ H ₃ O	6c (75)	6c (73)
4	C ₄ H ₃ S	6d (74)	6d (71)
5	<i>p</i> -PhBr	6e (78)	6e (75)

The reaction conditions were compatible with both steps and an example of a one-pot reaction was performed starting from **2a–2e**. The desired pyrrolines **6a–6e** were obtained in excellent yields (71–76%, Scheme 6 and Table 3).

Another important issue was the possibility of using these molecules as scaffolds for the preparation of focused chemical libraries. In order to explore this possibility we developed representative examples of Pd-catalyzed reactions starting from *p*-bromo derivatives **4e** and **6e**.

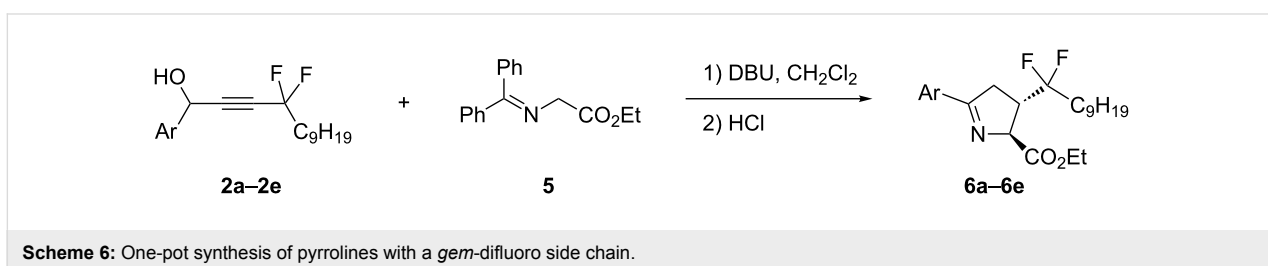
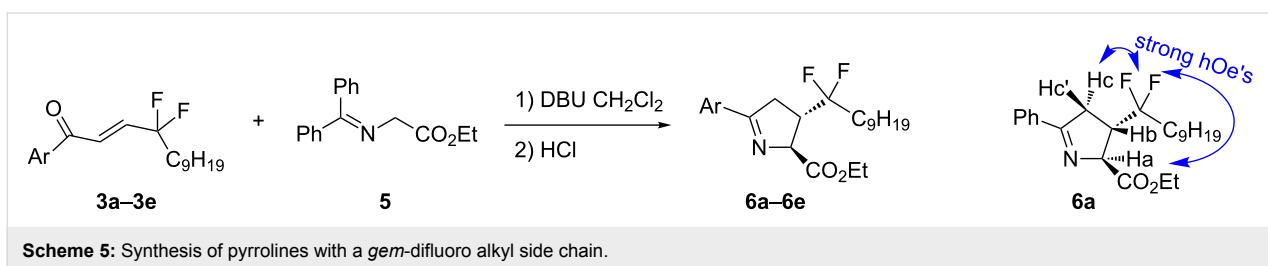

The results are given in Scheme 7 for pyrazoline **4e**. Suzuki–Miyaura coupling [35] gave biphenyl derivative **7e** in 82% yield, while the Heck [36] and Sonogashira [37] reactions afforded also the desired targets **8e** and **9e** in 72% and 77% yield respectively. Similar results were obtained in Pd-mediated reactions starting from pyrroline **6e**, as indicated in Scheme 8. The desired molecules **10e–12e** were obtained in good yields.

Conclusion

In summary, we developed an efficient access to enones with *gem*-difluoroalkyl side chains through a base-mediated isomerisation of fluorinated propargylic alcohols. Although this method is, to date, limited to compounds with aryl or heteroaryl substituents, corresponding enones appear as versatile intermediates for the preparation of heterocyclic derivatives. This has been established through the synthesis of pyrazolines

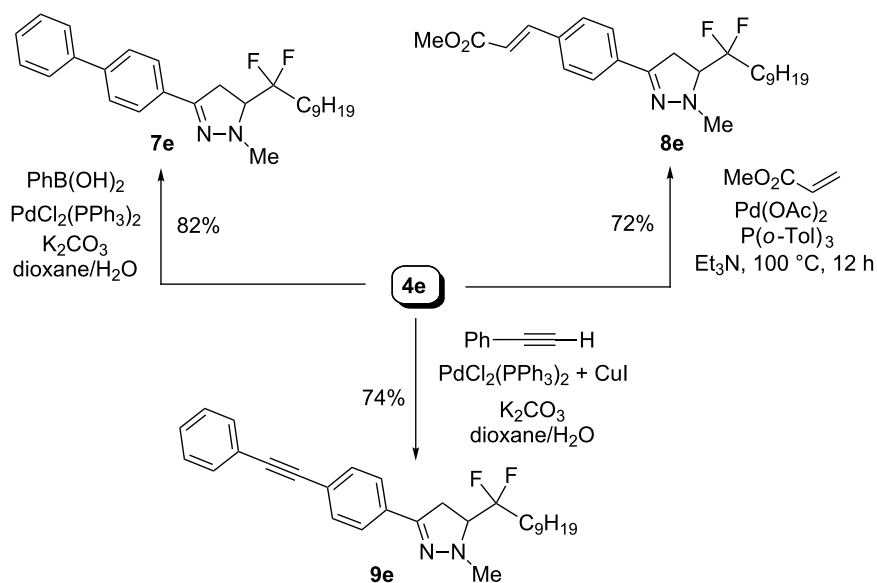

Scheme 7: Pd-catalyzed coupling reactions towards chemical libraries of pyrazolines with a *gem*-difluoro side chain.

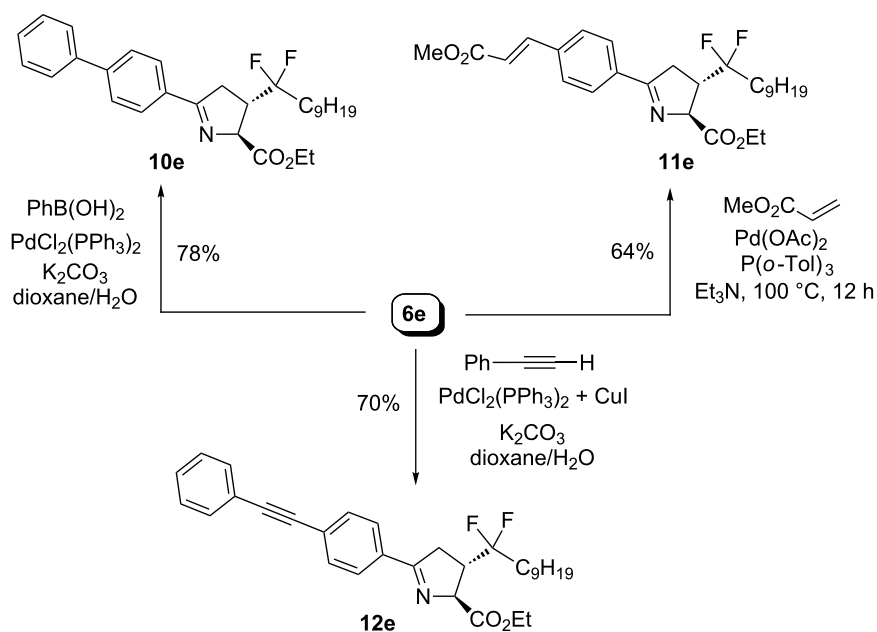

Scheme 8: Pd-catalyzed coupling reactions towards chemical libraries of pyrrolines with a *gem*-difluoro side chain.

and pyrrolines with *gem*-difluoroalkyl side chains. With appropriate substituents, derivatives of this type can be used for the preparation of chemical libraries.

Supporting Information

Supporting Information File 1

Experimental details, NMR analysis and characterization data of new compounds.

[<http://www.beilstein-journals.org/bjoc/content/supplementary/1860-5397-9-230-S1.pdf>]

Acknowledgements

We thank the CNRS and the University of Rennes 1 for financial support. We thank CRMPO (Rennes) for the mass spectral analyses.

References

- Ojima, I.; McCarthy, J. R.; Welch, J. T., Eds. *Biomedical Frontiers in Fluorine Chemistry*, American Chemical Society: Washington, DC, 1996. doi:10.1021/bk-1996-0639
- Welch, J. T.; Eswarakrishnan, S. *Fluorine in Bioorganic Chemistry*; Wiley-Interscience: New York, NY, USA, 1991.
- Welch, J. T. *Tetrahedron* **1987**, *43*, 3123. doi:10.1016/S0040-4020(01)90286-8
- Isanbor, C.; O'Hagan, D. *J. Fluorine Chem.* **2006**, *127*, 303. doi:10.1016/j.jfluchem.2006.01.011
- Bégué, J.-P.; Bonnet-Delpon, D. *J. Fluorine Chem.* **2006**, *127*, 992. doi:10.1016/j.jfluchem.2006.05.006
- Kirk, K. L. *J. Fluorine Chem.* **2006**, *127*, 1013. doi:10.1016/j.jfluchem.2006.06.007
- Hagman, W. K. *J. Med. Chem.* **2008**, *51*, 4359. doi:10.1021/jm800219f
- Filler, R.; Saha, R. *Future Med. Chem.* **2009**, *1*, 777. doi:10.4155/fmc.09.65
- O'Hagan, D. *J. Fluorine Chem.* **2010**, *131*, 1071. doi:10.1016/j.jfluchem.2010.03.003
- Dolle, R. E.; Le Bourdonnec, B.; Worm, K.; Morales, G. A.; Thomas, C. J.; Zhang, W. *J. Comb. Chem.* **2010**, *12*, 765. doi:10.1021/cc100128w
And references cited therein.
- Welsh, M. E.; Snyder, S. A.; Stockwell, B. R. *Curr. Opin. Chem. Biol.* **2010**, *14*, 347. doi:10.1016/j.cbpa.2010.02.018
And references cited therein.
- Prakesch, M.; Grée, D.; Grée, R. *Acc. Chem. Res.* **2002**, *35*, 175. doi:10.1021/ar010055i
- Pacheco, M. C.; Purser, S.; Gouverneur, V. *Chem. Rev.* **2008**, *108*, 1943. doi:10.1021/cr068410e
And references cited therein. See for a comprehensive review on the chemistry of propargylic allylic fluorides.
- Prakesch, M.; Kerouredan, E.; Grée, D.; Grée, R.; DeChancie, J.; Houk, K. N. *J. Fluorine Chem.* **2004**, *125*, 537. doi:10.1016/j.jfluchem.2003.11.027
- Manthathi, V. L.; Grée, D.; Grée, R. *Eur. J. Org. Chem.* **2005**, 3825. doi:10.1002/ejoc.200500200
- Manthathi, V. L.; Murthy, A. S. K.; Caijo, F.; Drouin, D.; Lesot, P.; Grée, D.; Grée, R. *Tetrahedron: Asymmetry* **2006**, *17*, 2306. doi:10.1016/j.tetasy.2006.08.010
And references cited therein.
- Grée, D.; Grée, R. *Tetrahedron Lett.* **2007**, *48*, 5435. doi:10.1016/j.tetlet.2007.06.007
- Pujari, S. A.; Kaliappan, K. P.; Valleix, A.; Grée, D.; Grée, R. *Synlett* **2008**, 2503. doi:10.1055/s-2008-1078179
- Blayo, A.-L.; Le Meur, S.; Grée, D.; Grée, R. *Adv. Synth. Catal.* **2008**, *350*, 471. doi:10.1002/adsc.200700488
- Bannwarth, P.; Valleix, A.; Grée, D.; Grée, R. *J. Org. Chem.* **2009**, *74*, 4646. doi:10.1021/jo900674u
- Bannwarth, P.; Grée, D.; Grée, R. *Tetrahedron Lett.* **2010**, *51*, 2413. doi:10.1016/j.tetlet.2010.02.116
- Bannwarth, P.; Grée, D.; Das, S.; Yadav, J. S.; Grée, R. *J. Fluorine Chem.* **2012**, *134*, 180. doi:10.1016/j.jfluchem.2011.03.003
- Arimitsu, S.; Fernández, B.; del Pozo, C.; Fustero, S.; Hammond, G. B. *J. Org. Chem.* **2008**, *73*, 2656. doi:10.1021/jo7025965
See for preparation of other series of fluoropropargylic derivatives by a completely different route.
- Xu, B.; Hammond, G. B. *Angew. Chem., Int. Ed.* **2005**, *44*, 7404. doi:10.1002/anie.200502807
See for preparation of other series of fluoropropargylic derivatives by a completely different route.
- Wang, Z. G.; Hammond, G. B. *J. Org. Chem.* **2000**, *65*, 6547. doi:10.1021/jo000832f
See also references cited therein and for preparation of other series of fluoropropargylic derivatives by a completely different route.
- Nineham, A. W.; Raphael, R. A. *J. Chem. Soc.* **1949**, 118. doi:10.1039/jr9490000118
- Sonye, J. P.; Koide, K. *J. Org. Chem.* **2007**, *72*, 1846. doi:10.1021/jo0623944
- Yamazaki, T.; Kawasaki-Takasuka, T.; Furuta, A.; Sakamoto, S. *Tetrahedron* **2009**, *65*, 5945. doi:10.1016/j.tet.2009.05.087
- Marella, A.; Ali, Md. R.; Alam, Md. T.; Saha, R.; Tanwar, O.; Akhter, M.; Shaquiquzzaman, Md.; Alam, M. M. *Mini-Rev. Med. Chem.* **2013**, *13*, 921. doi:10.2174/1389557511313060012
- Müller, T. J. J.; Ansorge, M.; Aktah, D. *Angew. Chem., Int. Ed.* **2000**, *39*, 1253. doi:10.1002/(SICI)1521-3773(20000403)39:7<1253::AID-ANIE1253>3.0.CO;2-X
- Bellina, F.; Rossi, R. *Tetrahedron* **2006**, *62*, 7213. doi:10.1016/j.tet.2006.05.024
- Zhang, Y.; Ran, C.; Zhou, G.; Sayre, L. M. *Bioorg. Med. Chem.* **2007**, *15*, 1868. doi:10.1016/j.bmc.2006.11.025
- Kawai, H.; Yuan, Z.; Kitayama, T.; Tokunaga, E.; Shibata, N. *Angew. Chem., Int. Ed.* **2013**, *52*, 5575. doi:10.1002/anie.201301123
- Marrec, O.; Christophe, C.; Billard, T.; Langlois, B.; Vors, J.-P.; Pazenoc, S. *Adv. Synth. Catal.* **2010**, *352*, 2825. doi:10.1002/adsc.201000487
- Miyaura, N.; Suzuki, A. *Chem. Rev.* **1995**, *95*, 2457. doi:10.1021/cr00039a007
- Heck, R. F.; Nolley, J. P., Jr. *J. Org. Chem.* **1972**, *37*, 2320. doi:10.1021/jo00979a024
- Sonogashira, K. *J. Organomet. Chem.* **2002**, *653*, 46. doi:10.1016/S0022-328X(02)01158-0

License and Terms

This is an Open Access article under the terms of the Creative Commons Attribution License (<http://creativecommons.org/licenses/by/2.0>), which permits unrestricted use, distribution, and reproduction in any medium, provided the original work is properly cited.

The license is subject to the *Beilstein Journal of Organic Chemistry* terms and conditions: (<http://www.beilstein-journals.org/bjoc>)

The definitive version of this article is the electronic one which can be found at:
[doi:10.3762/bjoc.9.230](https://doi.org/10.3762/bjoc.9.230)

Synthesis of enantiomerically pure (2*S*,3*S*)-5,5,5-trifluoroisoleucine and (2*R*,3*S*)-5,5,5-trifluoro-*allo*-isoleucine

Holger Erdbrink[‡], Elisabeth K. Nyakatura[‡], Susanne Huhmann,
Ulla I. M. Gerling, Dieter Lentz[§], Beate Koksch^{*} and Constantin Czekelius^{*}

Full Research Paper

Open Access

Address:
Department of Chemistry and Biochemistry, Freie Universität Berlin,
Takustr. 3, 14195 Berlin, Germany

Email:
Beate Koksch^{*} - beate.koksch@fu-berlin.de; Constantin Czekelius^{*} -
cczekeli@chemie.fu-berlin.de

* Corresponding author ‡ Equal contributors
§ Responsible for X-ray analysis.

Keywords:
amino acids; CD-spectroscopy; fluorine; helix propensity;
organo-fluorine; trifluoroisoleucine

Beilstein J. Org. Chem. 2013, 9, 2009–2014.
doi:10.3762/bjoc.9.236

Received: 19 June 2013
Accepted: 11 September 2013
Published: 02 October 2013

This article is part of the Thematic Series "Organo-fluorine chemistry III".

Guest Editor: D. O'Hagan

© 2013 Erdbrink et al; licensee Beilstein-Institut.
License and terms: see end of document.

Abstract

A practical route for the stereoselective synthesis of (2*S*,3*S*)-5,5,5-trifluoroisoleucine (L-5-F₃Ile) and (2*R*,3*S*)-5,5,5-trifluoro-*allo*-isoleucine (D-5-F₃-*allo*-Ile) was developed. The hydrophobicity of L-5-F₃Ile was examined and it was incorporated into a model peptide via solid phase peptide synthesis to determine its α -helix propensity. The α -helix propensity of 5-F₃Ile is significantly lower than Ile, but surprisingly high when compared with 4'-F₃Ile.

Introduction

Due to the unique physicochemical properties of fluorine, namely its small size, extremely low polarizability and the strongest inductive effect among all chemical elements [1], fluorine substitution has become a powerful tool for modulating the properties of pharmaceuticals and biologically active compounds. In this respect, the incorporation of amino acids with fluorinated side chains has been established as an efficient strategy to alter distinct properties of peptides and proteins, such as hydrophobicity, acidity/basicity, and conformation [2].

Numerous studies have focused on the incorporation of fluorinated aliphatic amino acids in helical folds [3-7], even though their intrinsic tendency to adopt this secondary structure (i.e. their α -helix propensity) was shown to be considerably reduced when compared to their canonical analogues [8,9]. Thus, if enhanced thermal stabilities of helical assemblies containing aliphatic fluorinated building blocks have been observed, this stability was mainly attributed to a higher hydrophobicity or the formation of a fluororous core [2,10]. Tirrell et al. found that the

biological function of the helical GCN4 transcription factor can be retained, when utilizing racemic mixtures of 5,5,5-trifluoroisoleucine (5-F₃Ile) as isoleucine surrogates for protein synthesis in *Escherichia coli* [11,12]. Moreover, studying the impact of global Ile substitution with 5-F₃Ile in comparison to the substitution of Val by 4,4,4-trifluorovaline (4-F₃Val) through protein expression, they showed that the replacement of the δ-CH₃ group of Ile by CF₃ resulted in an approximately eight-fold higher thermal stability of the respective GCN4 analogue than the replacement of the γ-CH₃ group of Val by CF₃ [12]. This finding was explained by the substantial loss of side-chain entropy of Val due to steric restriction between the significantly larger γ-CF₃ group and the helix. In agreement with these findings, we previously showed that the replacement of a CH₃ group by a CF₃ substituent in close proximity to the α-carbon of aliphatic amino acids dramatically reduces their α-helix propensity [13].

Since isolated α-helices are only marginally stable in solution, they are often stabilized in proteins by being wound around each other in a superhelix, a so-called coiled-coil arrangement, where hydrophobic side chain interactions are maximized within a helical interface. Coiled-coil structures are based on a (pseudo-) repetitive sequence (abcdefg)_n, the so-called heptad repeat, in which hydrophobic side chains are primarily located at the a- and d-positions on one side of the helix, while most of the other positions are hydrophilic or charged [2,14]. In a parallel helix alignment of coiled-coils, two fundamentally different packing geometries occur at hydrophobic core positions a and d. The α-β bond vector of the amino acid side chain can either point out of the hydrophobic core, termed *parallel packing*, or into the core and thus directly towards the neighboring helix (*perpendicular packing*). As a consequence, hydrophobic β-branched amino acids (Ile or Val) are the most stabilizing amino acids in parallel packing arrangements, because they project the hydrocarbon side chain from the β-carbon atom directly into the helical interface, whereas perpendicular packing precludes β-branched residues from occupying these sites and Leu is favored [14,15]. Therefore, the preparation of enantiomerically pure fluorinated isoleucine

analogues with retained α-helix propensity is of general interest for site-specific modification of coiled-coil positions in parallel packing arrangements, especially when solid phase peptide synthesis is employed.

Herein, we report a flexible approach to enantiomerically pure (2*S*,3*S*)-5,5,5-trifluoroisoleucine (L-5-F₃Ile) and (2*R*,3*S*)-5,5,5-trifluoro-*allo*-isoleucine (D-5-F₃-*allo*-Ile). Since the relationship of side chain hydrophobicity and α-helix propensity is of crucial importance for the overall stability of helical assemblies, these two properties were examined for L-5-F₃Ile, as one of the possible fluorinated analogues of proteinogenic isoleucine.

Results and Discussion

Amino acid synthesis

We have recently described a new method for the conjugate trifluoromethylation of α,β-unsaturated acyloxazolidinones [13]. Using this approach, all four diastereoisomers of *N*-Boc-protected 4,4,4-trifluorovaline as well as (2*S*,3*S*)-4,4,4-trifluoroisoleucine were prepared from the corresponding products in enantiomerically pure form via diastereoselective auxiliary-induced amination. It was found that both diastereoisomers of trifluorovaline and trifluoroisoleucine show extremely low α-helix propensities compared to their non-fluorinated analogues valine (Val) and isoleucine (Ile), which we attribute to steric clashes of the larger γ-CF₃ group with the helix backbone [13]. We wondered whether the replacement of the δ-CH₃ group of Ile by CF₃ might retain α-helix propensity. In light of the fact that 5,5,5-trifluoroisoleucine has mostly been synthesized and incorporated into peptides as diastereomeric mixtures so far [11,12,16], we decided to extend our previous approach towards the synthesis of (2*S*,3*S*)-5,5,5-trifluoroisoleucine. For this, we envisioned acyloxazolidinone **5** as an intermediate for the synthesis of enantiomerically pure L-5,5,5-trifluoroisoleucine [13,17]. For the synthesis of this building block we started from enantiomerically pure alcohol **1**, which was prepared using a modified protocol reported by Wang and Resnick from commercially available 4,4,4-trifluorobutanoic acid by diastereoselective enolate alkylation followed by reduction with lithium borohydride (Scheme 1) [18].

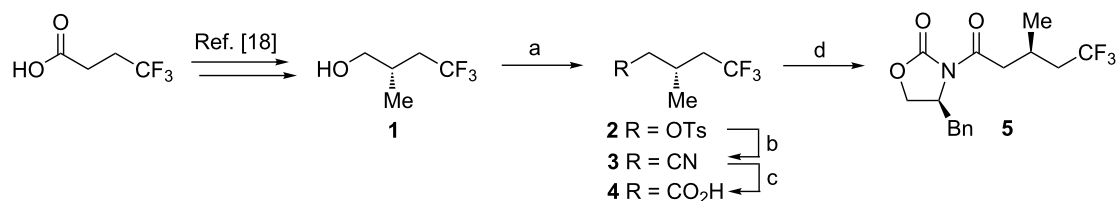

Scheme 1: Synthesis of optically active *N*-acyloxazolidinone **5** from 4,4,4-trifluorobutanoic acid. Conditions: (a) TsCl, DMAP (cat.), pyridine, 0 °C to rt, 12 h, 79%; (b) NaCN, NaI (cat.), DMSO, 60 °C, 2.5 h, 85%; (c) HCl (conc.), reflux, 2.5 h, 80%; (d) NEt₃, PivCl, THF, -78 °C to 0 °C, 90 min, then *n*-BuLi, (S)-4-benzylloxazolidin-2-one, THF, -78 °C to rt, overnight, 84%.

Fluorinated alcohol **1** was transformed into the corresponding tosylate ester **2** and subsequently reacted with sodium cyanide to afford nitrile **3**. Acid hydrolysis of **3** provided the enantiomerically pure carboxylic acid (*R*)-**4** [19], which was then coupled to the oxazolidinone via the mixed anhydride (Scheme 1). With *N*-acyloxazolidinone **5** in hand, the optically active fluorinated α -amino acids (L-5,5,5-trifluoroisoleucine **7** and D-5,5,5-trifluoro-*allo*-isoleucine **10**) were synthesized by stereoselective, auxiliary-induced amination following procedures reported by Evans and coworkers (Scheme 2) [17,20–24]. For this, acyloxazolidinone **5** was transformed into the α -azido derivative which upon reduction and auxiliary removal gave the *N*-Boc protected L-amino acid **7** (L-5-F₃Ile). Likewise, the corresponding D-amino acid **10** (D-5-F₃-*allo*-Ile) was prepared by α -bromination followed by nucleophilic azide displacement under stereochemical inversion (Scheme 2).

The absolute configuration of the amino acids was confirmed by crystal structure determination of intermediate **6**, based on the known auxiliary configuration (see Supporting Information File 1).

Hydrophobicity of L-5-F₃Ile

We investigated the relationship between side chain volume and hydrophobicity of L-5-F₃Ile. Since size and hydrophobicity are known to be essential factors for secondary structure formation, we compared 5-F₃Ile with previously studied (2*S*,3*S*)-4'-F₃Ile [13], as well as with (*S*)-5,5,5,5',5',5'-hexafluoroisoleucine (F₆Leu), which was prepared according to procedures reported by Keese and coworkers [25].

By plotting their side chain van der Waals volume versus their retention time from an RP-HPLC experiment, we previously investigated the relationship between size and hydrophobicity of various fluorinated and non-fluorinated amino acids [26]. In this experiment the non-polar phase of a reversed-phase column serves as a mimic of a biological membrane or the kind of hydrophobic interactions, that would be present in hydrophobic cores of proteins and in ligand–receptor binding [27]. We extended these initial studies by 2-aminoheptanoic acid (Aha) as an amino acid with an unbranched aliphatic side chain. The van der Waals volumes of the amino acid side chains were calculated according to Zhao et al. [28].

Aha correlates very well with its smaller non-fluorinated analogues and their retention time increases non-linearly with increasing side chain volume (Figure 1). As expected, the enlargement of the aliphatic side chain results in an increase in hydrophobicity.

In agreement with previous studies that focused on other fluorinated amino acids [26], also the retention times of 5-F₃Ile and 4'-F₃Ile do not fit into the correlation between side chain volume and retention time (Figure 1). Although similar in size, the two fluorinated stereoisomers of Ile are less hydrophobic than Aha. F₆Leu is similar to Aha in hydrophobicity, while exhibiting a much larger volume. In a free energy perturbation study, the hydration energy of F₆Leu was shown to be 1.1 kcal/mol higher than that of leucine [29]. This, together with our previous and new findings, suggests that there are two factors determining the overall hydrophobicity of fluorinated

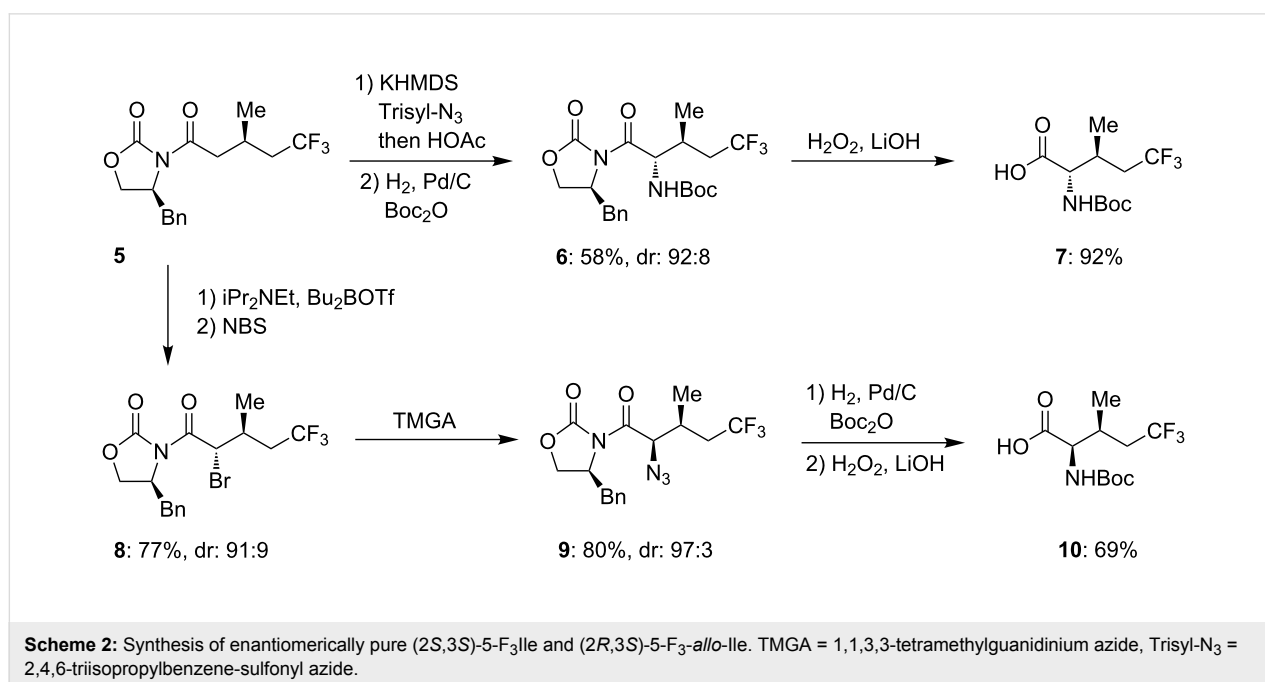

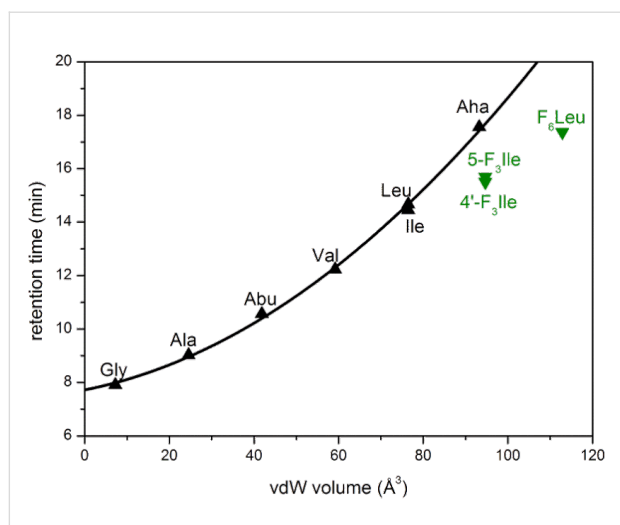

Figure 1: Retention times of Fmoc amino acids plotted against the van der Waals volume of their side chains. Non-fluorinated amino acids are depicted as black triangles; their correlation is shown as a black line. Fluorinated amino acids are represented by green triangles.

amino acids [26]. On one hand, substitutions of hydrogen by fluorine increase the solvent accessible surface area and thus lead to an increase in hydration energy. On the other hand, the C–F bond is more polarized than the C–H bond, and electrostatic interactions of the fluorinated group with the solvent are energetically more favored. As a consequence, fluoroalkyl side chains possess two seemingly contrary physicochemical properties, hydrophobicity and polarity, and the combination of both leaves fluorinated amino acids to be less hydrophobic than their surface area would suggest.

α -Helix propensity of L-5-F₃Ile

In general, fluorination of amino acids leads to a dramatic decrease in helix propensity [8,9,13]. As the extreme of this effect, we previously reported the complete loss of helix propensity when the β -methyl group in β -branched hydrophobic amino acids is replaced by a CF₃-substituent [13]. We now investigated the α -helix propensity of 5-F₃Ile according to methods established by Cheng et al., who showed that when an amino acid of interest is incorporated into an α -helical polyalanine model peptide (KX), its α -helix propensity can be calculated from circular dichroism (CD) spectroscopy [8,9]. Therefore, 5-F₃Ile was converted into its Fmoc analogue and subsequently used in solid-phase synthesis of K-5-F₃Ile applying standard Fmoc-based chemistry (see Supporting Information File 1) [30]. The α -helix propensity [ω] was calculated from CD data (Table 1).

Although the helix propensity of 5-F₃Ile is half of that for Ile, two distinct minima at 208 nm and 222 nm in the corresponding CD spectrum clearly indicate a helical structure of the

Table 1: Ellipticity [Θ] at 222 nm was taken from normalized CD data. Fraction helix [f_{helix}] and helix propensities [ω] were calculated from [$\Theta_{222 \text{ nm}}$] applying a modified Lifson–Roig theory [31–33].

peptide	[$\Theta_{222 \text{ nm}}$]	f_{helix}	ω
K-Ile	-13813 ± 156	0.40 ± 0.01	0.52 ± 0.05
K-5-F ₃ Ile	-10776 ± 216	0.31 ± 0.01	0.26 ± 0.03
K-4'-F ₃ Ile [13]	-3602 ± 130	0.10 ± 0.01	0

model peptide, whereas the absence of these minima in the K-4'-F₃Ile spectrum demonstrates a complete loss of helicity in the corresponding peptide (Figure 2). The drastic decrease in helix propensity upon fluorination has been previously attributed to a possible burial of fluorocarbon side chains in the unfolded state of the model peptide [8]. The exposure of these side chains in the helical state would lead to unfavourable helix formation energetics, due to the hydrophobic nature of fluorocarbon side chains. Moreover, due to its branching on the β -carbon atom, the side chain atoms of Ile come in close proximity to the peptide backbone [34], leading to a reduced α -helicity in comparison to its unbranched analogue ($[\omega]_{\text{Leu}} = 1.06$ [8]). This effect is amplified for K-4'-F₃Ile which carries the voluminous CF₃ group on its β -carbon atom. The close proximity of this sterically demanding group to the peptide backbone seems to prevent the formation of α -helical structures, resulting in a helix propensity of zero [13]. Here, we show that if isoleucine's δ -methyl group is substituted with CF₃, the α -helix propensity of this amino acid is partially retained.

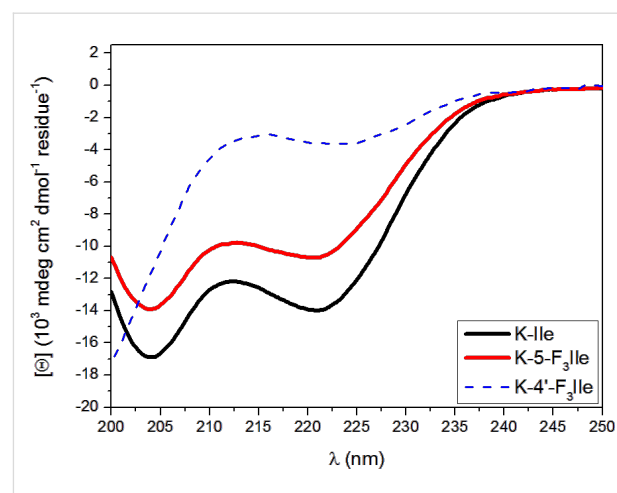

Figure 2: CD spectra of K-5-F₃Ile and K-Ile peptides (KX: Ac-YGGKAAAAKAXAAKAAAK-NH₂). The K-4'-F₃Ile spectrum [13] is shown for comparison. Spectra were recorded at pH 7 in 1 mM phosphate, borate, and citrate buffer with 1 M NaCl at 0 °C. Depicted spectra are normalized and represent the mean of three independent measurements at three different concentrations (80 μM , 50 μM , and 30 μM).

Conclusion

We synthesized two diastereoisomers of 5,5,5-trifluoroisoleucine ((2*S*,3*S*)-5-F₃Ile and (2*R*,3*S*)-5-F₃-*allo*-Ile) in enantiomerically pure form. The hydrophobicity of (2*S*,3*S*)-5-F₃Ile was shown to be increased in comparison to its proteinogenic analogue, but to a lesser extent than the surface area would suggest. The α -helix propensity of 5-F₃Ile, though lower than that of Ile, is significantly increased in comparison to (2*S*,3*S*)-4,4,4-trifluoroisoleucine. Thus, fluorinating isoleucine's δ -position rescues α -helix propensity, while the fluorination of isoleucine's β -branched methyl group abolishes it. It remains to be elucidated as to what extent helix propensity affects protein stability at buried positions, e.g. within hydrophobic cores of proteins, since the reduced helix propensity may in part be attributed to unfavorable solvent interactions at exposed positions of the applied monomeric model peptide. Since hydrophobic, β -branched amino acids are the most stabilizing amino acids in parallel packing arrangements within the hydrophobic core of coiled-coils [14,15], we believe that 5-F₃Ile demonstrates a promising building block for fluorine modifications within this folding motif.

Supporting Information

Supporting Information File 1

Experimental procedures, characterization data, copies of all ¹H, ¹³C, and ¹⁹F NMR spectra of all new compounds.

[<http://www.beilstein-journals.org/bjoc/content/supplementary/1860-5397-9-236-S1.pdf>]

Acknowledgements

This work has been generously supported by the DFG in the context of the Graduiertenkolleg 1582 "Fluorine as a key element".

References

- Smart, B. E. *J. Fluorine Chem.* **2001**, *109*, 3–11. doi:10.1016/S0022-1139(01)00375-X
- Salwiczek, M.; Nyakatura, E. K.; Gerling, U. I. M.; Ye, S.; Kokscho, B. *Chem. Soc. Rev.* **2012**, *41*, 2135–2171. doi:10.1039/c1cs15241f
- Salwiczek, M.; Samsonov, S.; Vagt, T.; Nyakatura, E.; Fleige, E.; Numata, J.; Cölfen, H.; Pisabarro, M. T.; Kokscho, B. *Chem.–Eur. J.* **2009**, *15*, 7628–7636. doi:10.1002/chem.200802136
- Bilgiçer, B.; Fichera, A.; Kumar, K. *J. Am. Chem. Soc.* **2001**, *123*, 4393–4399. doi:10.1021/ja002961j
- Lee, H.-Y.; Lee, K.-H.; Al-Hashimi, H. M.; Marsh, E. N. G. *J. Am. Chem. Soc.* **2006**, *128*, 337–343. doi:10.1021/ja0563410
- Nyakatura, E. K.; Reimann, O.; Vagt, T.; Salwiczek, M.; Kokscho, B. *RSC Adv.* **2013**, *3*, 6319–6322. doi:10.1039/c3ra41110a
- Vagt, T.; Nyakatura, E.; Salwiczek, M.; Jäckel, C.; Kokscho, B. *Org. Biomol. Chem.* **2010**, *8*, 1382–1386. doi:10.1039/b917205j
- Chiu, H.-P.; Suzuki, Y.; Gullickson, D.; Ahmad, R.; Kokona, B.; Fairman, R.; Cheng, R. P. *J. Am. Chem. Soc.* **2006**, *128*, 15556–15557. doi:10.1021/ja0640445
- Chiu, H.-P.; Cheng, R. P. *Org. Lett.* **2007**, *9*, 5517–5520. doi:10.1021/ol702470j
- Buer, B. C.; Meagher, J. L.; Stuckey, J. A.; Marsh, E. N. G. *Proc. Natl. Acad. Sci. U. S. A.* **2012**, *109*, 4810–4815. doi:10.1073/pnas.1120112109
- Wang, P.; Tang, Y.; Tirrell, D. A. *J. Am. Chem. Soc.* **2003**, *125*, 6900–6906. doi:10.1021/ja0298287
- Son, S.; Tanrikulu, I. C.; Tirrell, D. A. *ChemBioChem* **2006**, *7*, 1251–1257. doi:10.1002/cbic.200500420
- Erdbrink, H.; Peuser, I.; Gerling, U. I. M.; Lentz, D.; Kokscho, B.; Czekelius, C. *Org. Biomol. Chem.* **2012**, *10*, 8583–8586. doi:10.1039/c2ob26810h
- Woolfson, D. N. *Adv. Protein Chem.* **2005**, *70*, 79–112. doi:10.1016/S0065-3233(05)70004-8
- Wagschal, K.; Tripet, B.; Mant, C.; Hodges, R. S.; Lavigne, P. *Protein Sci.* **1999**, *8*, 2312–2329. doi:10.1110/ps.8.11.2312
- Muller, N. *J. Fluorine Chem.* **1987**, *36*, 163–170. doi:10.1016/S0022-1139(00)81023-4
- Kreft, A. F.; Resnick, L.; Mayer, S. C.; Diamantidis, G.; Cole, D. C.; Harrison, B. L.; Zhang, M.; Hoke, M.; Wang, T.; Galante, R. J. Fluoro- and trifluoroalkyl-containing heterocyclic sulfonamide inhibitors of beta amyloid. U.S. Patent 20040198778, Oct 7, 2004. See for a related intermediate that has been previously reported for the preparation of compounds derived from (2*S*,3*R*)-5-F₃-*allo*-Ile using a different synthetic route.
- Wang, Z.; Resnick, L. *Tetrahedron* **2008**, *64*, 6440–6443. doi:10.1016/j.tet.2008.04.072
- Pigza, J. A.; Quach, T.; Molinski, T. F. *J. Org. Chem.* **2009**, *74*, 5510–5515. doi:10.1021/jo900654y
- Evans, D. A.; Britton, T. C.; Ellman, J. A.; Dorow, R. L. *J. Am. Chem. Soc.* **1990**, *112*, 4011–4030. doi:10.1021/ja00166a045
- Evans, D. A.; Ellman, J. A.; Dorow, R. L. *Tetrahedron Lett.* **1987**, *28*, 1123–1126. doi:10.1016/S0040-4039(00)95305-X
- Dharanipragada, R.; Nicolas, E.; Toth, G.; Hruby, V. J. *Tetrahedron Lett.* **1989**, *30*, 6841–6844. doi:10.1016/S0040-4039(01)93366-0
- Dharanipragada, R.; VanHulle, K.; Bannister, A.; Bear, S.; Kennedy, L.; Hruby, V. J. *Tetrahedron* **1992**, *48*, 4733–4748. doi:10.1016/S0040-4020(01)81570-2
- Li, G.; Patel, D.; Hruby, V. J. *J. Chem. Soc., Perkin Trans. 1* **1994**, 3057–3059. doi:10.1039/P19940003057
- Zhang, C.; Ludin, C.; Eberle, M. K.; Stoeckli-Evans, H.; Keese, R. *Helv. Chim. Acta* **1998**, *81*, 174–181. doi:10.1002/hlca.19980810116
- Samsonov, S. A.; Salwiczek, M.; Anders, G.; Kokscho, B.; Pisabarro, M. T. *J. Phys. Chem. B* **2009**, *113*, 16400–16408. doi:10.1021/jp906402b
- Kovacs, J. M.; Mant, C. T.; Hodges, R. S. *Pept. Sci.* **2006**, *84*, 283–297. doi:10.1002/bip.20417
- Zhao, Y. H.; Abraham, M. H.; Zissimos, A. M. *J. Org. Chem.* **2003**, *68*, 7368–7373. doi:10.1021/jo034808o
- Pendley, S. S.; Yu, Y. B.; Cheatham, T. E., III. *Proteins: Struct., Funct., Bioinf.* **2009**, *74*, 612–629. doi:10.1002/prot.22177
- Fields, G. B.; Noble, R. L. *Int. J. Pept. Protein Res.* **1990**, *35*, 161–214. doi:10.1111/j.1399-3011.1990.tb00939.x
- Chakrabarty, A.; Kortemme, T.; Baldwin, R. L. *Protein Sci.* **1994**, *3*, 843–852. doi:10.1002/pro.5560030514

32. Doig, A. J.; Chakrabarty, A.; Klingler, T. M.; Baldwin, R. L. *Biochemistry* **1994**, *33*, 3396–3403. doi:10.1021/bi00177a033
33. Andersen, N. H.; Tong, H. *Protein Sci.* **1997**, *6*, 1920–1936. doi:10.1002/pro.5560060913
34. Minor, D. L., Jr.; Kim, P. S. *Nature* **1994**, *367*, 660–663. doi:10.1038/367660a0

License and Terms

This is an Open Access article under the terms of the Creative Commons Attribution License (<http://creativecommons.org/licenses/by/2.0>), which permits unrestricted use, distribution, and reproduction in any medium, provided the original work is properly cited.

The license is subject to the *Beilstein Journal of Organic Chemistry* terms and conditions: (<http://www.beilstein-journals.org/bjoc>)

The definitive version of this article is the electronic one which can be found at:
[doi:10.3762/bjoc.9.236](https://doi.org/10.3762/bjoc.9.236)

Regioselective carbon–carbon bond formation of 5,5,5-trifluoro-1-phenylpent-3-en-1-yne

Motoki Naka, Tomoko Kawasaki-Takasuka and Takashi Yamazaki*

Full Research Paper

Open Access

Address:

Division of Applied Chemistry, Graduate School of Engineering,
Tokyo University of Agriculture and Technology, 2-24-16, Nakamachi,
Koganei 184-8588, Japan

Email:

Takashi Yamazaki* - tyamazak@cc.tuat.ac.jp

* Corresponding author

Keywords:

additives; computation; Li...F chelation; deprotonation;
electron-withdrawing effect; organo-fluorine

Beilstein J. Org. Chem. 2013, 9, 2182–2188.

doi:10.3762/bjoc.9.256

Received: 10 August 2013

Accepted: 08 October 2013

Published: 23 October 2013

This article is part of the Thematic Series "Organo-fluorine chemistry III".

Guest Editor: D. O'Hagan

© 2013 Naka et al; licensee Beilstein-Institut.

License and terms: see end of document.

Abstract

The regioselective carbon–carbon bond formation was studied using 5,5,5-trifluoro-1-phenylpent-3-en-1-yne as a model substrate, and predominant acceptance of electrophiles β to a CF_3 group as well as a deuterium trap experiment of the lithiated species led to the conclusion that the obtained regioselectivity is kinetically determined for the reactions with electrophiles, under equilibration of the possible two anionic species.

Introduction

We have previously reported [1] the interesting behavior of (*E*)-1-chloro-3,3,3-trifluoropropene ((*E*)-**1**) [2-4] towards MeLi, where the proportion of two possible products, propargylic alcohols **2** and allylic alcohols **3**, was proved to be significantly dependent on the equivalents of MeLi used. Thus, as shown in Scheme 1, under the action of up to 1.6 equiv of MeLi, **2** was obtained as a sole product probably by initial H^b abstraction from (*E*)-**1** and the resultant Int-**1** was stabilized by the energetically favorable 5-membered intramolecular Li...F chelation [5]. This intermediate Int-**1** experienced Fritsch–Buttenberg–Wiechell (FBW) rearrangement [6,7] to give 3,3,3-trifluoropropyne, and Int-**2** derived from this alkyne eventually captured appropriate aldehydes to afford CF_3 -containing propargylic

alcohols **2** [8-12]. Alternatively, stereospecific and exclusive construction of the corresponding allylic alcohols **3** was attained by utilization of greater than 1.7 equiv of MeLi where the stabilized intermediate Int-**3** formed by complexation of Int-**1** with MeLi might play an important role. It turned out that the isomeric (*Z*)-**1** as a substrate furnished only **2** [13] even by the addition of 1.7 equiv of MeLi, presumably as a result of regioselective deprotonation of H^a , followed by smooth elimination [14,15] of the *trans*-disposed chlorine atom. However, it is also likely that the anionic intermediate produced after H^b abstraction would prefer the reaction course to **2** by way of FBW rearrangement because of its lower stability than Int-**1** with loss of the possibility for Li...F chelation.

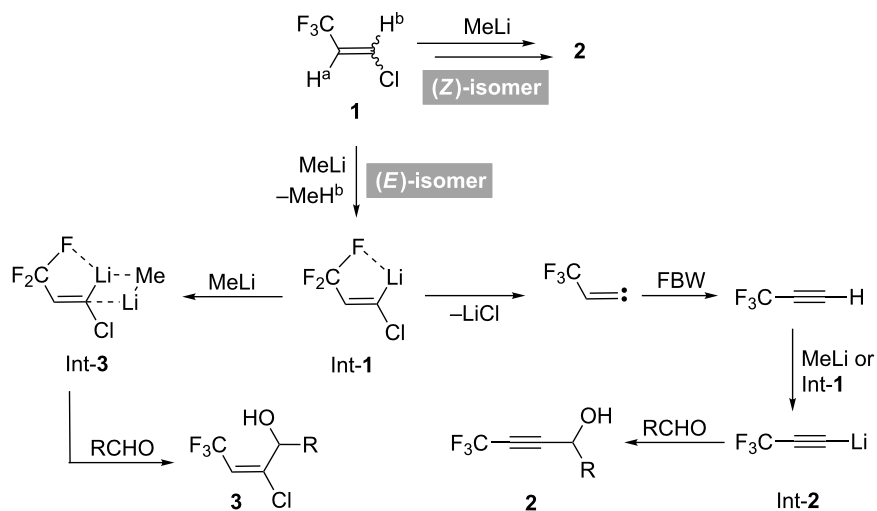

Scheme 1: Proposed reaction mechanism between **1** and MeLi.

It was not only MeLi but also LDA which demonstrated this unique base-amount dependent product selectivity of (*E*)-**1** and this substrate was successfully converted to **2** or a mixture of **2:3** = 25:75 by the action of 1.2 or 2.2 equiv of LDA, respectively. Although these phenomena are quite interesting, issues remain to be solved for complete mechanistic understanding of the process depicted in Scheme 1.

For clarification of the reactivity of (*E*)-**1** on deprotonation, enyne **4** was used as a model because, after trapping the vinylic anionic species by appropriate electrophiles, comparison of the yields of the resultant regioisomeric **5** and **6** would give us a hint for solving this puzzling question. Moreover, we also expected that such data as well as the additional deuterium trap experiment would offer deeper insight to the actual mechanism.

Results and Discussion

Investigation of reaction conditions was initially carried out in Et₂O. A complete recovery of **4** was observed irrespective of the base used (Table 1, entries 1 and 2).

Neither were **5a** and **6a** detected in THF when MeLi or *n*-BuLi were employed and this system produced only a complex mixture (Table 1, entries 3 and 4). A survey of bases established that, in spite of failures with PhMgBr and LHMDS, the use of LDA led to the formation of **5a** and **6a** in 24 and 6% yields, respectively, after trapping the resultant anionic intermediates by PhCHO (Table 1, entries 5 to 7). An increase in LDA concentration to 2 equiv improved the yield of product to 41% (**5a**) and 10% (**6a**), but additional LDA was not effective (Table 1, entries 8 and 9). Subsequent to determining that LDA was the base of choice, a brief study of the effect of additives was

performed. The addition of HMPA or DMPU was detrimental and no trace amount of **4**, **5a**, nor **6a** was detected (Table 1, entries 10 and 11). However, TMEDA affected this process to some extent (Table 1, entries 5 vs 12) [16–18], and the addition of 2 equiv each of LDA and TMEDA produced the regioisomeric **5a** and **6a** in better yields of 68% and 11%, respectively (Table 1, entry 13). The recovery of 15% of the substrate **4** under these conditions prompted further raise in their amount to 3 equiv, but again, no significant improvement was noticed (Table 1, entries 13 vs 14). The effect of temperature on the reaction was crucial. Thus, efficient deprotonation was not occurred at –100 °C (Table 1, entry 15) with the consequence that decomposition of the vinylic anions at –40 °C led to formation of different intermediates which would further consume LDA, leaving a larger amount of **4** unreacted (Table 1, entry 17). In conclusion, the reaction conditions in entry 13 in Table 1 were selected to be optimal.

With optimized conditions in hand, the scope and limitation of this procedure were investigated. A number of carbonyl compounds were employed as electrophiles for the anions generated from the enyne **4**. Benzaldehydes with electron-donating (Table 2, entries 2 and 3) as well as -withdrawing (Table 2, entry 4) substituents at the para position were nicely accepted as electrophiles. The allylic alcohols **5** were formed as the major product without exception in a similar **5**/(**5**+**6**) ratio of 70–75% (Table 2, entries 1 to 5). An inseparable mixture of the compounds **5** and **6** was also synthesized from aliphatic aldehydes as shown in entries 5 and 6 in Table 2. Their proportion seemed to be affected by the bulky substituent and pivalaldehyde attained the higher ratio of 88%. Although **5** and **6** were obtained in 50 to 70% combined yields by the reaction with

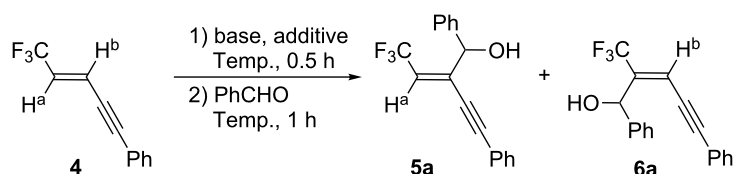
Table 1: Investigation of reaction conditions.

Entry	Solvent	Base (equiv)	Additive (equiv)	Temp. (°C)	¹⁹ F NMR Yield (%)		Recov. ^a (%)
					5a	6a	
1	Et ₂ O	<i>n</i> -BuLi (1.0)	—	-80	0	0	100
2		MeLi (1.0)	—	-80	0	0	100
3	THF	<i>n</i> -BuLi (1.0)	—	-80	0	0	5
4		MeLi (1.0)	—	-80	0	0	17
5		LDA (1.0)	—	-80	24	6	20
6		PhMgBr (1.0)	—	-80	0	0	17
7		LHMDS (1.0)	—	-80	0	0	17
8		LDA (2.0)	—	-80	41	10	15
9		LDA (3.0)	—	-80	44	8	32
10		LDA (1.0)	HMPA (1.0)	-80	— ^b		
11		LDA (1.0)	DMPU (1.0)	-80	— ^b		
12		LDA (1.0)	TMEDA (1.0)	-80	34	2	11
13		LDA (2.0)	TMEDA (2.0)	-80	68	11	15
14		LDA (3.0)	TMEDA (3.0)	-80	64	19	14
15		LDA (2.0)	TMEDA (2.0)	-100	19	5	76
16		LDA (2.0)	TMEDA (2.0)	-60	50	17	1
17		LDA (2.0)	TMEDA (2.0)	-40	— ^b		43
18		LDA (2.0)	TMEDA (2.0)	-80 ^c	54	17	8

^aRecovered starting material. ^bAlmost no fluorinated products were detected by ¹⁹F NMR. ^cAfter addition of PhCHO, stirring was continued for 1 h at -80 °C, followed by 3 h at 0 °C.

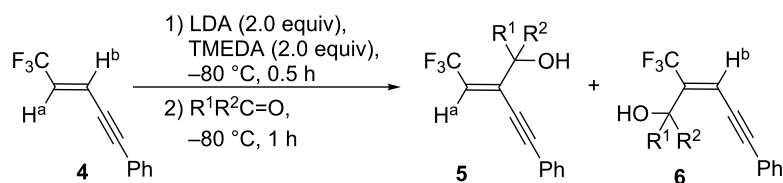
Table 2: Scope and limitation of the present reactions.

Entry	R ¹	R ²	Product	Isolated yield ^a (%)		5/(5+6) ^b (%)	Recov. ^c (%)
				5	6		
1	Ph-	H	a	50 (65)	21 (25)	72	15
2	<i>p</i> -Me-C ₆ H ₄ -	H	b	49 (52)	17 (17)	75	18
3	<i>p</i> -MeO-C ₆ H ₄ -	H	c	49 (43)	15 (17)	72	16
4	<i>p</i> -F ₃ C-C ₆ H ₄ -	H	d	36 (43)	12 (17)	72	32
5	Et-	H	e	47 (57)	16 (19)	75	26
6	<i>t</i> -Bu-	H	f	54 (59)	10 (8)	88	23
7	Ph-	Me-	g	(15)	(8)	65	52

^aIn the parenthesis were shown the yields determined by ¹⁹F NMR. ^bThese ratios were determined by ¹⁹F NMR for the crude materials. ^cRecovered starting material.

aldehydes, lower reactivity was displayed by the less electrophilic and more hindered acetophenone. Products **5g** and **6g** were formed in 15% and 8% yields, respectively, while there was a 52% recovery of **4** under these conditions detected by ^{19}F NMR (Table 2, entry 7).

Compounds **5** and **6** were readily characterized by ^{19}F NMR spectra. The former material showed clear 3J couplings of 7 to 9 Hz between F and H^{a} , but with the latter $^4J_{\text{F-Hb}}$ was usually not observed. Moreover, the fact that isolation of the furan **7a** in 51% yield was realized by subjection of a 70:30 mixture of inseparable **5a** and **6a** to the already reported Pd-catalyzed cyclization conditions [19] suggested that the major isomer should be **5a**, not **6a** (Scheme 2). In the case of **5** and **6**, electrophiles were incorporated without stereochemical contamination in all instances.

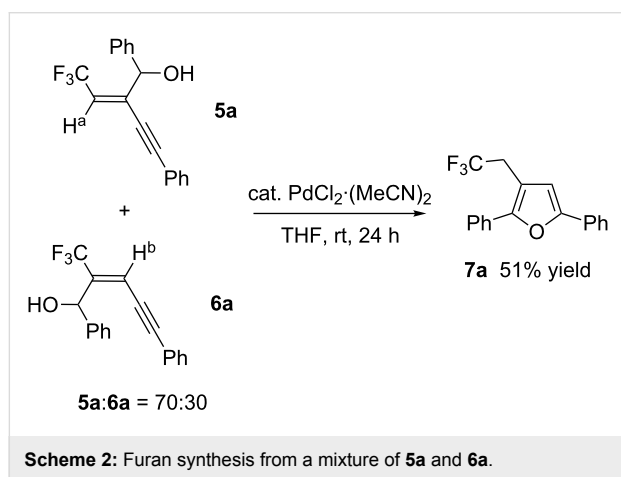

For obtaining further mechanistic proofs for the present reaction, we have planned to capture the intermediary anionic species with the aid of the usual deuteration technique. Thus, a large excess amount (26 equiv) of CD_3OD was introduced to a solution containing the anionic species which was prepared from **4** by the standard conditions, which expected us to obtain a mixture of **4-d1** and **4-d2** or either of them predominantly (Scheme 3).

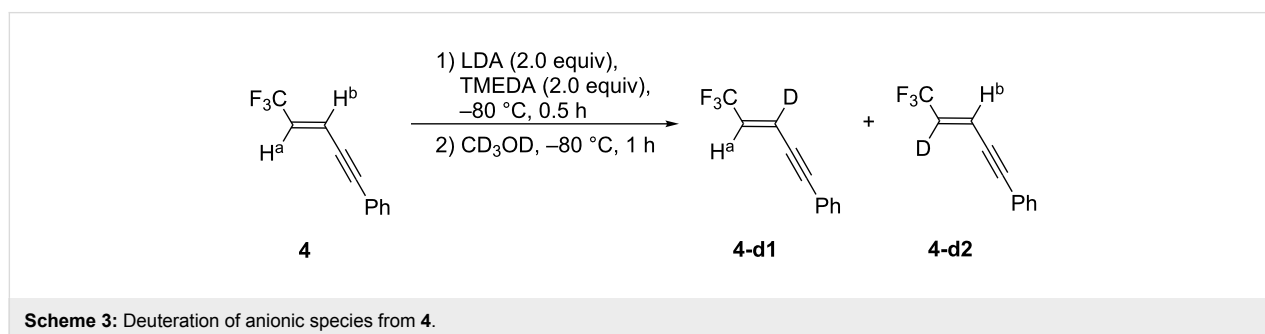

Observation of the well-resolved two sets of peaks was possible for the two vinylic protons H^{a} and H^{b} in the enyne **4** at δ 6.15 (qd, $J = 6.6, 15.9$ Hz) and 6.48 (qd, $J = 2.4, 15.9$ Hz), respectively (Figure 1 and Supporting Information File 1).

On the other hand, relatively complex peaks were detected from the crude deuterated mixture due to incomplete quench of the reactive anionic species by CD_3OD , but new resonance peaks (indicated by ■ and ▲) undoubtedly appeared with overlapping the ones of the original H^{a} (★) and H^{b} (●). At the lower field (around 6.5 ppm) area, peaks indicated by ▲ are considered as a part of quartet with a coupling constant of 2.3 Hz, which is close to the $^4J_{\text{H-F}}$ coupling value of **4** shown above. Moreover, disappearance of the large $^3J_{\text{H-H}}$ constant typical for (*E*)-alkenes suggested that a deuterium atom should be incorporated at the site where H^{a} was originally situated and that **4-d2** was actually produced. It is also clear that the H^{a} region also contains a couple of peaks (■) with the $^3J_{\text{H-F}}$ coupling constant of 6.6 Hz basically identical to the one of **4**, which anticipated us the simultaneous formation of the regioisomeric **4-d1** on the basis of the similar consideration.

Thus, lithiation of **4** and the following quench with CD_3OD furnished a mixture of **4-d1** and **4-d2**, which directly proved that the both lithiated species **4-Li1** and **4-Li2** were actually generated (Scheme 4), although it is quite unfortunate not to be able to quantitatively discuss the proportion of **4-d1** to **4-d2**. On the other hand, as apparent from Table 2, aldehydes preferentially yielded **5** with qualitatively better ratio of **5/6** than the one of **4-d1/4-d2**. Our computation of **4-Li1** and **4-Li2** by Gaussian 09W [20] using the B3LYP/6-31+G* level of theory uncovered that the former was energetically more favorable than the latter by 5.34 (3.67) kcal/mol under vacuum (in THF [21]), which would indicate that intramolecular $\text{Li}\cdots\text{F}$ chelation is contributed to the stability more significantly rather than the electron-withdrawing stabilization by the CF_3 group. Thus, with this computational information in hand, the process shown in Scheme 4 would be elucidated as follows: deuteration would quickly occur to afford **4-d1** and **4-d2** whose proportion would reflect the ratio of **4-Li1** and **4-Li2**. On the other hand, less

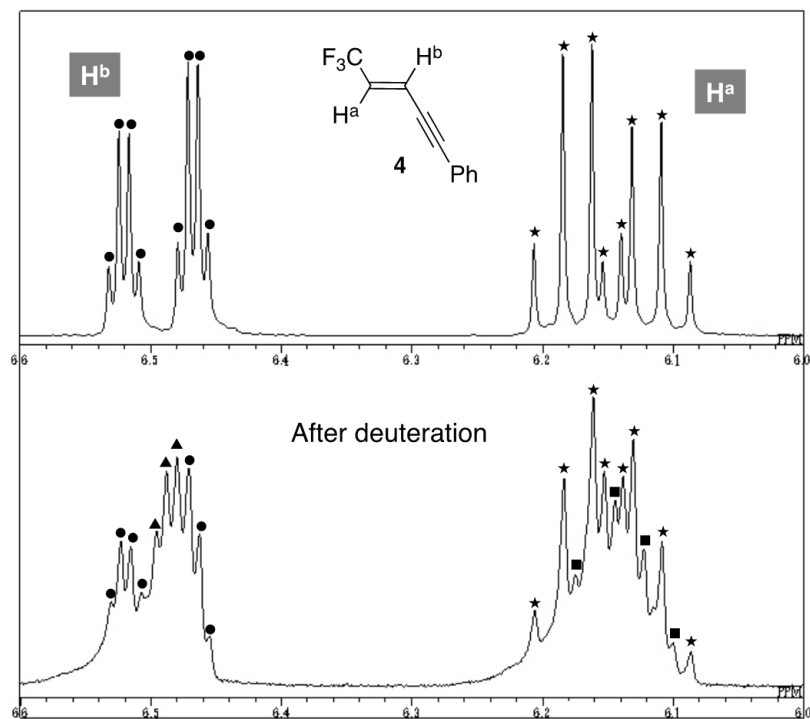
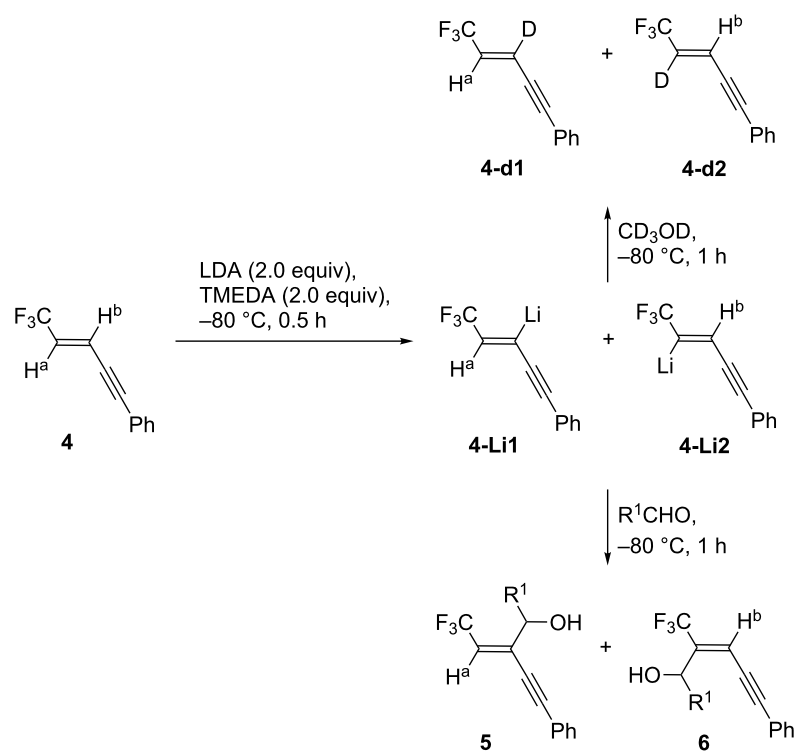

Figure 1: A part of ^1H NMR chart of **4** and its deuterated mixture.



Scheme 4: Lithiation of **4** and the following electrophilic reactions.

reactive aldehydes should be captured more slowly and the product preference of **5** to **6** would be kinetically determined by their activation energy difference with equilibration between these two lithiated species in the presence of such a proton source as $i\text{Pr}_2\text{NH}$ [22].

This interpretation also led to the reconsideration of the proposed mechanism shown in Scheme 1. If deprotonation of both H^a and H^b in (*E*)-**1** was possible, lithiated species Int-4 and Int-1 was obtained, respectively (Scheme 5). Due to slow elimination of a LiCl molecule from Int-4 due to the *cis* relationship of Li and Cl, Int-4 would act as a base to abstract a terminal proton of 3,3,3-trifluoropropyne via FBW rearrangement of Int-1. The regenerated (*E*)-**1** would be converted to a mixture of Int-1 and Int-4 again to eventually yield the propargylic alco-

hols **2**. However, a larger amount of MeLi would allow constructing the complex Int-3 presumably with possessing better stability and the allylic alcohols **3** were obtained. In the case of the stereoisomeric (*Z*)-**1**, situation was totally different, and Int-5 without intramolecular chelation should accelerate the elimination of LiCl and the ideal *trans* disposition of Li and Cl in Int-6 also favored the route to trifluoropropyne, and as a result, propargylic alcohols **2** were selectively afforded.

Conclusion

By using the representative model substrate **4**, we have reached to a conclusion that its initial lithiation would occur at both vinylic sites and the following reactions with appropriate electrophiles would proceed under kinetic control where equilibration of the resultant lithiated species might be effective if the capture of electrophiles was slow. This important information allowed us to reconsider our previously proposed mechanism as shown in Scheme 5.

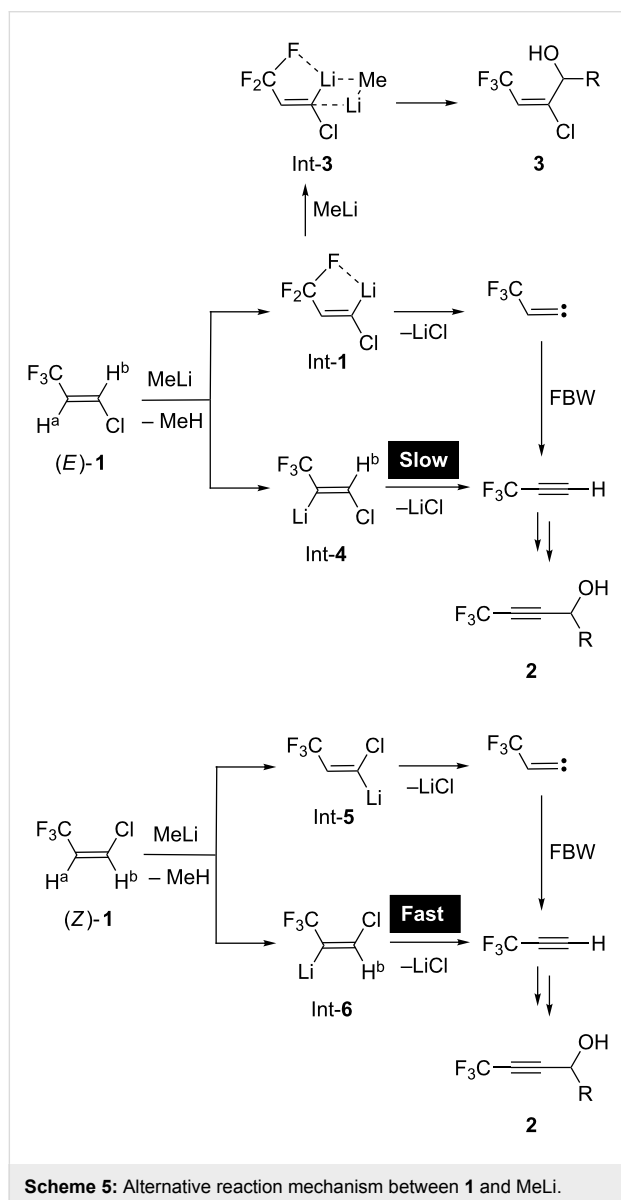

Supporting Information

Supporting Information File 1

Experimental.

[<http://www.beilstein-journals.org/bjoc/content/supplementary/1860-5397-9-256-S1.pdf>]

References

- Miyagawa, A.; Naka, M.; Yamazaki, T.; Kawasaki-Takasuka, T. *Eur. J. Org. Chem.* **2009**, 4395–4399. doi:10.1002/ejoc.200900370
- Taguchi, T.; Tomizawa, G.; Nakajima, M.; Kobayashi, Y. *Chem. Pharm. Bull.* **1985**, 33, 4077–4080. doi:10.1248/cpb.33.4077
- Quan, H.-D.; Yang, H.-E.; Tamura, M.; Sekiya, A. *J. Fluorine Chem.* **2007**, 128, 190–195. doi:10.1016/j.jfluchem.2006.12.004
- Komata, T.; Akiba, S.; Hosoi, K.; Ogura, K. *J. Fluorine Chem.* **2008**, 129, 35–39. doi:10.1016/j.jfluchem.2007.08.007
- Shinohara, N.; Haga, J.; Yamazaki, T.; Kitazume, T.; Nakamura, S. *J. Org. Chem.* **1995**, 60, 4363–4374. doi:10.1021/jo00119a013
- Jahnke, E.; Tykwinski, R. R. *Chem. Commun.* **2010**, 46, 3235–3249. doi:10.1039/c003170d
- Knorr, R. *Chem. Rev.* **2004**, 104, 3795–3850. doi:10.1021/cr030616h
- Tajammal, S.; Tipping, A. E. *J. Fluorine Chem.* **1990**, 47, 45–57. doi:10.1016/S0022-1139(00)80446-7
- Mizutani, K.; Yamazaki, T.; Kitazume, T. *J. Chem. Soc., Chem. Commun.* **1995**, 51–52. doi:10.1039/C39950000051
- Katritzky, A. R.; Qi, M.; Wells, A. P. *J. Fluorine Chem.* **1996**, 80, 145–147. doi:10.1016/S0022-1139(96)03494-X
- Brisdon, A. K.; Crossley, I. R. *Chem. Commun.* **2002**, 2420–2421. doi:10.1039/b207979h
- Shimizu, M.; Higashi, M.; Takeda, Y.; Murai, M.; Jiang, G.; Asai, Y.; Nakao, Y.; Shirakawa, E.; Hiyama, T. *Future Med. Chem.* **2009**, 1, 921–945. doi:10.4155/fmc.09.69
- Eymery, F.; Iorga, B.; Savignac, P. *Synthesis* **2000**, 185–213. doi:10.1055/s-2000-6241

14. Cristol, S. J.; Begoon, A.; Norris, W. P.; Ramey, P. S. *J. Am. Chem. Soc.* **1954**, *76*, 4558–4561. doi:10.1021/ja01647a015
15. Behr, O. M.; Eglinton, G.; Lardy, I. A.; Raphael, R. A. *J. Chem. Soc.* **1964**, 1151–1154. doi:10.1039/jr9640001151
16. Kacem, Y.; Hassine, B. B. *Tetrahedron Lett.* **2013**, *54*, 4023–4025. doi:10.1016/j.tetlet.2013.05.082
17. Riggs, J. C.; Singh, K. J.; Yun, M.; Collum, D. B. *J. Am. Chem. Soc.* **2008**, *130*, 13709–13717. doi:10.1021/ja804087r
18. Grant, B. J.; Kramp, C. R.; Knight, J. D.; Meierhoefer, M. A.; Vella, J. H.; Sober, C. L.; Jones, S. S.; Metz, C. R.; Beam, C. F.; Pennington, W. T.; Vanderveer, D. G.; Camper, N. D. *J. Heterocycl. Chem.* **2007**, *44*, 627–632. doi:10.1002/jhet.5570440318
19. Qing, F.-L.; Gao, W.-Z.; Ying, J. *J. Org. Chem.* **2000**, *65*, 2003–2006. doi:10.1021/jo991463u
20. *Gaussian 09*, Revision C.01; Gaussian, Inc.: Wallingford CT, 2009.
21. The integral equation formalism polarizable continuum model (IEF-PCM) was used for consideration of the solvent effect of THF.
22. Mongin, F.; Tognini, A.; Cottet, F.; Schlosser, M. *Tetrahedron Lett.* **1998**, *39*, 1749–1752. doi:10.1016/S0040-4039(98)00028-8

License and Terms

This is an Open Access article under the terms of the Creative Commons Attribution License (<http://creativecommons.org/licenses/by/2.0>), which permits unrestricted use, distribution, and reproduction in any medium, provided the original work is properly cited.

The license is subject to the *Beilstein Journal of Organic Chemistry* terms and conditions: (<http://www.beilstein-journals.org/bjoc>)

The definitive version of this article is the electronic one which can be found at:
[doi:10.3762/bjoc.9.256](https://doi.org/10.3762/bjoc.9.256)

Regioselective 1,4-trifluoromethylation of α,β -unsaturated ketones via a *S*-(trifluoromethyl)diphenylsulfonium salts/copper system

Satoshi Okusu, Yutaka Sugita, Etsuko Tokunaga and Norio Shibata*

Letter

Open Access

Address:
Department of Frontier Materials, Graduate School of Engineering,
Nagoya Institute of Technology, Gokiso, Showa-ku, Nagoya
466-8555, Japan

Email:
Norio Shibata* - nozshiba@nitech.ac.jp

* Corresponding author

Keywords:
1,4-addition; copper; fluorine; Michael addition; organo-fluorine;
trifluoromethylation

Beilstein J. Org. Chem. 2013, 9, 2189–2193.
doi:10.3762/bjoc.9.257

Received: 27 August 2013
Accepted: 10 October 2013
Published: 23 October 2013

This article is part of the Thematic Series "Organo-fluorine chemistry III".

Guest Editor: D. O'Hagan

© 2013 Okusu et al; licensee Beilstein-Institut.
License and terms: see end of document.

Abstract

Regioselective conjugate 1,4-trifluoromethylation of α,β -unsaturated ketones by the use of shelf-stable electrophilic trifluoromethylating reagents, *S*-(trifluoromethyl)diphenylsulfonium salts and copper under mild conditions is described. A wide range of acyclic aryl–aryl–enones and aryl–alkyl–enones were converted into β -trifluoromethylated ketones in low to moderate yields.

Introduction

One of the challenges in synthetic organic chemistry is the nucleophilic 1,4-addition of the trifluoromethyl (CF_3) group into electron-deficient internal alkenes as represented by the Michael addition reaction, even in a racemic, non-stereoselective fashion [1-5]. The nucleophilic trifluoromethylation to conjugated alkenes essentially occurs solely via a 1,2-addition

[1-11], not a 1,4-addition (Scheme 1), with the exception of non-general examples of 1,4-additive trifluoromethylation of (trifluoromethyl)trimethylsilane (Me_3SiCF_3 , Ruppert–Prakash reagent) to very specific substrates such as *trans*-1-benzoyl-2-(dimethylamino)ethylene [12], 2-polyfluoroalkylchromones [13,14], isoxazoles with a nitro group at the 4-position [15], and

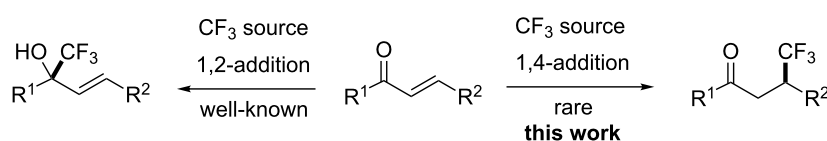

Scheme 1: Trifluoromethylation of α,β -unsaturated ketones.

Morita–Baylis–Hillman adducts (via S_N2' [16] or successive S_N2'/S_N2' mode [17]).

Sevenard and co-workers reported the nucleophilic 1,4-trifluoromethylation to chromones, coumarins and cyclohex-2-enone using the Ruppert–Prakash reagent, which was achieved by blocking the carbonyl moiety of the substrates with a bulky aluminium-centered Lewis acid with low to moderate yields [18]. Dilman and co-workers partially overcame this problem by using highly electrophilic alkenes bearing either Meldrum's acids [19], or two geminal nitrile groups [20]. However, direct 1,4-trifluoromethylation to conventional α,β -unsaturated ketones such as chalcone is very tough, presumably due to the hardness of the CF_3 anion. Recently, we reported the copper-mediated trifluoromethylation at the benzylic position by using shelf-stable electrophilic trifluoromethylating reagents, *S*-(trifluoromethyl)diphenylsulfonium salts, in good to high yields under mild conditions [21]. In this reaction, a bromide at the benzylic position would be replaced by a CF_3 anion mediated

by a copper via SET process, although the reaction mechanism is not clear. We envisaged that the system could be applicable to the conjugated 1,4-trifluoromethylation to simple chalcones. During the preparation of this article, the Nicewicz group showed a single example of conjugate trifluoromethylation of chalcone with sodium trifluoromethanesulfinate salt in the presence of *N*-methyl-9-mesitylacridinium as a photoredox catalyst resulting in a low product yield of 31% as a mixture of regioisomers (C2/C3 1.1:1) [22]. We disclose herein the regioselective 1,4-addition of the CF_3 group into simple conjugated acyclic enones including chalcones using *S*-(trifluoromethyl)diphenylsulfonium salt **3** and a copper system in 11–37% yields (12 examples).

Results and Discussion

We initiated our investigation with the reaction of chalcone (**1a**) using a series of electrophilic trifluoromethylating reagents **3** [23–26] in the presence of copper in DMF at 60 °C (Table 1), based on previously reported conditions [21]. First, the tri-

Table 1: Optimization of CF_3 reagents, metal, and solvent for copper-mediated conjugate trifluoromethylation of chalcone (**1a**).^a

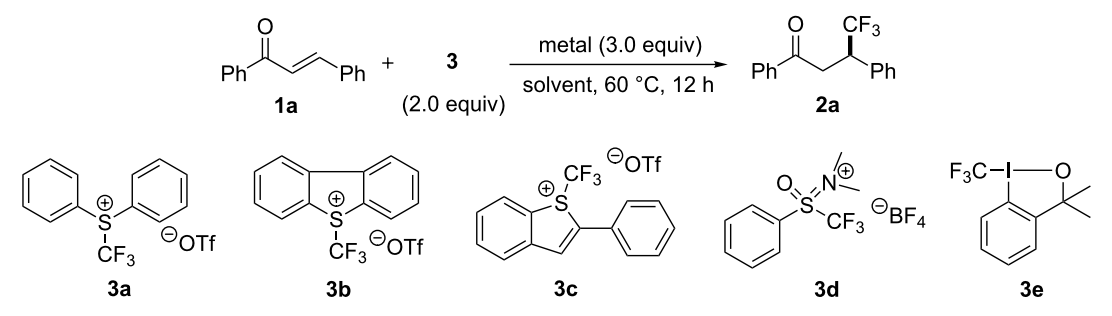

Entry	CF_3 reagent	metal	solvent	Yield (%) ^b
1	3a	Cu	DMF	4
2	3a	Cu	NMP	6
3	3a	Cu	DMSO	11
4	3a	Cu	DMF/H ₂ O (1:1)	23
5	3a	Ni	DMF/H ₂ O (1:1)	9
6	3a	Zn	DMF/H ₂ O (1:1)	trace
7	3a	Cu	NMP/H ₂ O (1:1)	trace
8	3a	Cu	DMSO/H ₂ O (1:1)	5
9 ^c	3a	Cu	DMF/H ₂ O (1:1)	25
10 ^c	3a	Cu	DMSO/H ₂ O (1:1)	37
11	3b	Cu	DMSO/H ₂ O (1:1)	24
12 ^c	3b	Cu	DMSO/H ₂ O (1:1)	27
13	3c	Cu	DMSO/H ₂ O (1:1)	trace
14	3d	Cu	DMSO/H ₂ O (1:1)	0
15	3e	Cu	DMSO/H ₂ O (1:1)	trace
16	Me ₃ SiCF ₃	Cu	DMSO/H ₂ O (1:1)	0
17 ^{c,d}	3a	Cu	DMSO/H ₂ O (1:1)	trace ^e

^aThe reaction of **1a** with **3** (2.0 equiv) was carried out in the presence of metal (3.0 equiv) at 60 °C. ^bIsolated yield. ^c**3** (4.0 equiv) and metal (6.0 equiv) were used. ^dThe reaction was performed in the presence of TEMPO (4.0 equiv). ^eO-Trifluoromethylated TEMPO was detected in 2% by ¹⁹F NMR.

fluoromethylation of **1a** with *S*-(trifluoromethyl)diphenylsulfonium salt **3a** was attempted, and a desired product **2a** was obtained in only 4% yield (Table 1, entry 1). Next the solvent was screened for yield improvement. We attempted the same reaction using NMP and DMSO, and the desired product **2a** was obtained in 6% and 11% yields (Table 1, entries 2 and 3, respectively). Interestingly, adding water (DMF/H₂O 1:1) effectively improved the yield to 23% (Table 1, entry 4). Reactions mediated by other metals, such as Ni and Zn, either gave poor yields (Table 1, entries 5 and 6). The use of larger excesses of *S*-(trifluoromethyl)diphenylsulfonium salt **3a** (4.0 equiv) and Cu (6.0 equiv) in DMF/H₂O (1:1) led to an increase in the yield of **2a** (Table 1, entry 9). The best result was obtained by treating **1a** at 60 °C in DMSO/H₂O (1:1) in the presence of *S*-(trifluoromethyl)diphenylsulfonium salt **3a** (4.0 equiv) and Cu (6.0 equiv), leading to the isolation of **2a** in 37% yield (Table 1, entry 10). Using 4.0 equiv of Umemoto's reagent **3b** instead of **3a** gave the product **2a** in 27% yield (Table 1, entry 12). *S*-(Trifluoromethyl)benzothiophenium salt **3c** [24], trifluoromethylsulfoxinium salt **3d** [25], and hypervalent iodine(III) CF₃ reagent **3e** [26] did not proceed or provided only a trace amount of the desired product **2a** under the same reaction conditions (Table 1, entries 13–15). No reaction was observed using Ruppert–Prakash reagent in the presence of Cu under the same conditions (Table 1, entry 16). In all the cases, the reaction was regioselective and a trace amount of regioisomers and/or byproducts was detected in a crude mixture analyzed by ¹⁹F NMR. Under the best conditions shown in entry 10, we re-examined the reaction, but in the presence of TEMPO. The

product formation was inhibited by TEMPO and *O*-trifluoromethylated TEMPO was detected in 2% by ¹⁹F NMR analysis (Table 1, entry 17).

With suitable conditions in hand, the scope of copper-mediated conjugate trifluoromethylation of α,β -unsaturated ketones **1** with **3a** was explored with a variety of substrates selected in order to establish the generality of the process (Table 2). With respect to the aryl ketone group, aromatic rings substituted with either electron-donating or -withdrawing substituents, such as methyl, methoxy, fluoro and chloro were tolerated (Table 2, entries 2–4). A heteroaromatic, furanyl-substituted enone was compatible with the same reaction conditions (Table 2, entry 6). We next examined substrates differing in the nature of the β -aryl substituents under the same reaction conditions. A series of compounds with aromatic rings substituted with either electron-donating or -withdrawing substituents, such as methyl, methoxy, fluoro and chloro were also acceptable. Furthermore, the β -alkyl-substituted enone also produced the desired product **2l** (Table 2, entry 12).

Based on these results, we hypothesized the reaction mechanism as shown in Scheme 2. First, the conjugate trifluoromethylation of α,β -unsaturated ketones would be initiated by a single-electron transfer between *S*-(trifluoromethyl)diphenylsulfonium salt **3a** and copper. The intermediate **4** decomposes to give the CF₃ radical whose generation is supported by the TEMPO inhibition experiment. Ph₂S was formed and checked by the ¹H NMR spectroscopy. The resulting CF₃ radical reacted

Table 2: Copper-mediated conjugate trifluoromethylation of α,β -unsaturated ketones **1** with **3a**.^a

Entry	1	Ar	R	2	Yield (%) ^b
1	1a	Ph	Ph	2a	37
2	1b	4-MeC ₆ H ₄	Ph	2b	20
3	1c	4-MeOC ₆ H ₄	Ph	2c	11
4	1d	4-FC ₆ H ₄	Ph	2d	13
5	1e	4-ClC ₆ H ₄	Ph	2e	22
6	1f	2-furanyl	Ph	2f	13
7	1g	Ph	4-MeC ₆ H ₄	2g	12
8	1h	Ph	4-MeOC ₆ H ₄	2h	12
9	1i	Ph	4-FC ₆ H ₄	2i	17
10	1j	Ph	3-ClC ₆ H ₄	2j	18
11	1k	Ph	4-ClC ₆ H ₄	2k	13
12	1l	Ph	Me	2l	36

^aThe reaction of **1a** with **3a** (4.0 equiv) was carried out in the presence of Cu (6.0 equiv) at 60 °C. ^bIsolated yield.

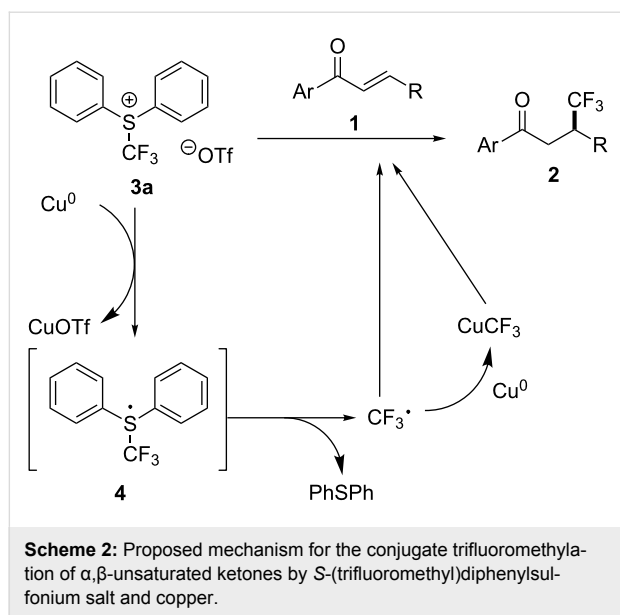

directly with α,β -unsaturated ketones **1** and/or through the formation of CuCF_3 species to provide the 1,4-adduct **2** in low to moderate yield. Although the true reactive species including CF_3 radical and/or CuCF_3 are not clear, the naked CF_3 radical should be ruled out since high regioselectivity was observed, otherwise, a 1:1 mixture of regioisomers (C2/C3) should be detected like in the photoredox trifluoromethylation reaction [22].

Conclusion

We developed for the first time the copper-mediated conjugate trifluoromethylation of simple α,β -unsaturated ketones through the use of shelf-stable electrophilic trifluoromethylating reagent **3a** under mild conditions. Although the yields are low, wide substrate generality was observed. Getting higher yields for this chemistry [27–29] and extension to asymmetric conjugate trifluoromethylation to simple α,β -unsaturated ketones are both our subsequent challenges and we are currently working in these directions.

Supporting Information

Supporting Information File 1

Experimental section.

[<http://www.beilstein-journals.org/bjoc/content/supplementary/1860-5397-9-257-S1.pdf>]

Acknowledgements

This study was financially supported in part by the Platform for Drug Discovery, Informatics, and Structural Life Science from the Ministry of Education, Culture, Sports, Science and Tech-

nology, Japan, by Grants-in-Aid for Scientific Research from MEXT (Ministry of Education, Culture, Sports, Science and Technology) (24105513, Project No. 2304: Advanced Molecular Transformation by Organocatalysts) and JST (ACT-C: Creation of Advanced Catalytic Transformation for the Sustainable Manufacturing at Low Energy, Low Environmental Load).

References

- Ma, J.-A.; Cahard, D. *Chem. Rev.* **2008**, *108*, PR1–PR43. doi:10.1021/cr800221v
- Shibata, N.; Mizuta, S.; Kawai, H. *Tetrahedron: Asymmetry* **2008**, *19*, 2633–2644. doi:10.1016/j.tetasy.2008.11.011
- Prakash, G. K. S.; Yudin, A. K. *Chem. Rev.* **1997**, *97*, 757–786. doi:10.1021/cr9408991
- Prakash, G. K. S.; Mandal, M. *J. Fluorine Chem.* **2001**, *112*, 123–131. doi:10.1016/S0022-1139(01)00477-8
- Billard, T.; Langlois, B. R. *Eur. J. Org. Chem.* **2007**, 891–897. doi:10.1002/ejoc.200600643
- Kawai, H.; Yuan, Z.; Tokunaga, E.; Shibata, N. *Org. Biomol. Chem.* **2013**, *11*, 1446–1450. doi:10.1039/c3ob27368g
- Prakash, G. K. S.; Jog, P. V.; Batamack, P. T. D.; Olah, G. A. *Science* **2012**, *338*, 1324–1327. doi:10.1126/science.1227859
- Billard, T.; Bruns, S.; Langlois, B. R. *Org. Lett.* **2000**, *2*, 2101–2103. doi:10.1021/ol005987o
- Singh, R. P.; Kirchmeier, R. L.; Shreeve, J. M. *Org. Lett.* **1999**, *1*, 1047–1049. doi:10.1021/ol990844r
- Matsukawa, S.; Saijo, M. *Tetrahedron Lett.* **2008**, *49*, 4655–4657. doi:10.1016/j.tetlet.2008.05.053
- Kawano, Y.; Kaneko, N.; Mukaiyama, T. *Bull. Chem. Soc. Jpn.* **2006**, *79*, 1133–1145. doi:10.1246/bcsj.79.1133
- Large, S.; Roques, N.; Langlois, B. R. *J. Org. Chem.* **2000**, *65*, 8848–8856. doi:10.1021/jo000150s
- Sosnovskikh, V. Y.; Sevenard, D. V.; Usachev, B. I.; Röschenhaler, G.-V. *Tetrahedron Lett.* **2003**, *44*, 2097–2099. doi:10.1016/S0040-4039(03)00184-9
- Sosnovskikh, V. Y.; Usachev, B. I.; Sevenard, D. V.; Röschenhaler, G.-V. *J. Org. Chem.* **2003**, *68*, 7747–7754. doi:10.1021/jo034591y
- Kawai, H.; Tachi, K.; Tokunaga, E.; Shiro, M.; Shibata, N. *Angew. Chem., Int. Ed.* **2011**, *50*, 7803–7806. doi:10.1002/anie.201102442
- Zemtsov, A. A.; Levin, V. V.; Dilman, A. D.; Struchkova, M. I.; Belyakov, P. A.; Tartakovsky, V. A.; Hu, J. *Eur. J. Org. Chem.* **2010**, 6779–6785. doi:10.1002/ejoc.201001051
- Furukawa, T.; Nishimine, T.; Tokunaga, E.; Hasegawa, K.; Shiro, M.; Shibata, N. *Org. Lett.* **2011**, *13*, 3972–3975. doi:10.1021/ol201490e
- Sevenard, D. V.; Sosnovskikh, V. Y.; Kolomeitsev, A. A.; Königsman, M. H.; Röschenhaler, G.-V. *Tetrahedron Lett.* **2003**, *44*, 7623–7627. doi:10.1016/j.tetlet.2003.08.050
- Zemtsov, A. A.; Levin, V. V.; Dilman, A. D.; Struchkova, M. I.; Belyakov, P. A.; Tartakovsky, V. A. *Tetrahedron Lett.* **2009**, *50*, 2998–3000. doi:10.1016/j.tetlet.2009.03.188
- Dilman, A. D.; Levin, V. V.; Belyakov, P. A.; Struchkova, M. I.; Tartakovsky, V. A. *Tetrahedron Lett.* **2008**, *49*, 4352–4354. doi:10.1016/j.tetlet.2008.05.039
- Kawai, H.; Tachi, K.; Tokunaga, E.; Shiro, M.; Shibata, N. *Org. Lett.* **2010**, *12*, 5104–5107. doi:10.1021/ol102189c

22. Wilger, D. J.; Gesmundo, N. J.; Nicewicz, D. A. *Chem. Sci.* **2013**, *4*, 3160–3165. doi:10.1039/c3sc51209f
23. Shibata, N.; Matsnev, A.; Cahard, D. *Beilstein J. Org. Chem.* **2010**, *6*, No. 65. doi:10.3762/bjoc.6.65
24. Matsnev, A.; Noritake, S.; Nomura, Y.; Tokunaga, E.; Nakamura, S.; Shibata, N. *Angew. Chem., Int. Ed.* **2010**, *49*, 572–576. doi:10.1002/anie.200905225
25. Noritake, S.; Shibata, N.; Nakamura, S.; Toru, T.; Shiro, M. *Eur. J. Org. Chem.* **2008**, 3465–3468. doi:10.1002/ejoc.200800419
26. Eisenberger, P.; Gischig, S.; Togni, A. *Chem.–Eur. J.* **2006**, *12*, 2579–2586. doi:10.1002/chem.200501052
27. This chemistry is complement the previous one based in the isomerization of trifluoromethylated allylic alcohols (see reference [28]) or the carbanion addition to trifluoromethyl enones (see reference [29]).
28. Bizet, V.; Pannecoucke, X.; Renaud, J.-L.; Cahard, D. *J. Fluorine Chem.* **2013**, *152*, 56–61. doi:10.1016/j.jfluchem.2013.01.004
29. Maruoka, K.; Shimada, I.; Imoto, H.; Yamamoto, H. *Synlett* **1994**, 519–520. doi:10.1055/s-1994-22912

License and Terms

This is an Open Access article under the terms of the Creative Commons Attribution License (<http://creativecommons.org/licenses/by/2.0>), which permits unrestricted use, distribution, and reproduction in any medium, provided the original work is properly cited.

The license is subject to the *Beilstein Journal of Organic Chemistry* terms and conditions: (<http://www.beilstein-journals.org/bjoc>)

The definitive version of this article is the electronic one which can be found at:
[doi:10.3762/bjoc.9.257](https://doi.org/10.3762/bjoc.9.257)

Direct electrophilic *N*-trifluoromethylthiolation of amines with trifluoromethanesulfenamide

Sébastien Alazet^{1,2}, Kevin Ollivier¹ and Thierry Billard^{*1,2}

Letter

Open Access

Address:

¹Institute of Chemistry and Biochemistry (ICBMS – UMR CNRS 5246), Université de Lyon, Université Lyon 1, CNRS, 43 Bd du 11 novembre 1918 – 69622 Lyon, France and ²CERMEP - in vivo imaging, Groupement Hospitalier Est, 59 Bd Pinel – 69003 Lyon, France

Email:

Thierry Billard* - thierry.billard@univ-lyon1.fr

* Corresponding author

Keywords:

amine; fluorine; organo-fluorine; trifluoromethanesulfenamide; trifluoromethylsulfanylamine; trifluoromethylthiolation

Beilstein J. Org. Chem. **2013**, *9*, 2354–2357.

doi:10.3762/bjoc.9.270

Received: 02 August 2013

Accepted: 10 October 2013

Published: 04 November 2013

This article is part of the Thematic Series "Organo-fluorine chemistry III".

Guest Editor: D. O'Hagan

© 2013 Alazet et al; licensee Beilstein-Institut.

License and terms: see end of document.

Abstract

The CF₃SN moiety is a substituent with interesting properties. However, there is no easy synthetic access to molecules bearing this group. The trifluoromethanesulfenamide is a new reagent for the electrophilic trifluoromethylthiolation which reacts easily with amines to obtain trifluoromethylsulfanylamines with good yields.

Introduction

In past decades, fluorinated molecules have found more and more applications in a variety of fields, especially in the design of new compounds for medicinal chemistry or agrochemistry [1-9]. More recently, new substituents have emerged which associate the trifluoromethyl group with heteroatoms such as CF₃O or CF₃S. Because of its high hydrophobicity (Hansch parameter $\pi_R = 1.44$), the CF₃S moiety is of particular interest [10]. Compounds with this group constitute important targets for applications in pharmaceuticals and agrochemicals [4,11-13].

The association of a CF₃ group to more than one heteroatom is rarely described in literature. In particular, there are only a few investigations regarding the trifluoromethylsulfanylamine

moiety (CF₃SN). However, this group has found applications in agrochemical and medicinal chemistry [14-20]. From a physicochemical point of view, the CF₃SN group possesses a Hansch's hydrophobicity parameter $\pi_R = 1.50$ [21]. This value, slightly superior to the Hansch's hydrophobicity parameter of the CF₃S group, could be of great interest in the development of biological active compounds. Yet, the common synthetic route to these compounds use the highly toxic and gaseous CF₃SCl [16,22-35].

Results and Discussion

Several years ago, we have described an easy access to trifluoromethanesulfenamides [36], starting from DAST, Ruppert reagent, and primary amines [37]. However, even though this

strategy gave good results with primary amines, secondary amines do not react under these conditions, thus limiting the access to a large panel of trifluoromethylsulfanyl amines. The trifluoromethanesulfenamide **1a** is an efficient reagent for the electrophilic trifluoromethylthiolation of carbon nucleophiles [38–44]. Therefore, this reagent should react with amines to perform transamination reactions with secondary amines leading to various trifluoromethylsulfanyl amines **3**. The reaction has been optimized with phenylpiperazine (**2a**) (Table 1).

After preliminary deprotonation of **2a** with BuLi, the trifluoromethanesulfenamide **1a** is added. The expected product **3a** is obtained in 15 min with good yield. To improve the kinetic of the reaction, the deprotonation and the transamination should be performed at 0 °C (Table 1, entries 1 and 2). Longer reaction times do not increase the yield, the reaction seems to be finished in 15 min (Table 1, entries 2 and 3). As previously observed in other works, the use of other bases with sodium or cesium cations is not efficient since only Li is a Lewis acid strong enough to activate **1a** [38,44]. These optimal conditions have been extended to selected amines **2** (Figure 1).

The reaction gives, in general, good yields with various secondary amines (**3a–k**). Because of their high volatility, some compounds (**3h** and **3i**) have not been isolated. Imines can be also trifluoromethylthiolated in good yields (**3m**). Even if our first developed method is compatible with primary amines [37], they

Table 1: Reaction of phenylpiperazine (**2a**) with **1a** under basic conditions.

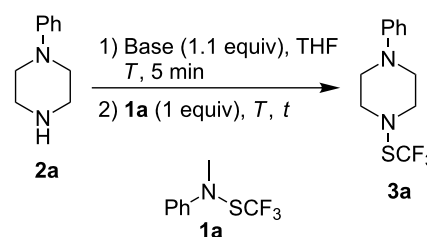

Entry	Base	<i>T</i> (°C)	<i>t</i>	3a (%) ^a
1	BuLi	−78	15 min	65
2	BuLi	0	15 min	86
3	BuLi	0	3 h	84
4	NaH	0	15 min	0
5	Cs ₂ CO ₃	80	2 h 30	0

^aCrude yields determined by ¹⁹F NMR spectroscopy by using PhOCF₃ as an internal standard.

can also react under these new conditions, as illustrated with the aniline (**3n**).

Amino alcohols and bis-amines can also be trifluoromethylthiolated, with the most nucleophile atom as a target (Figure 2). In this case, 2.1 equiv of BuLi are required and reaction times are longer (20 h).

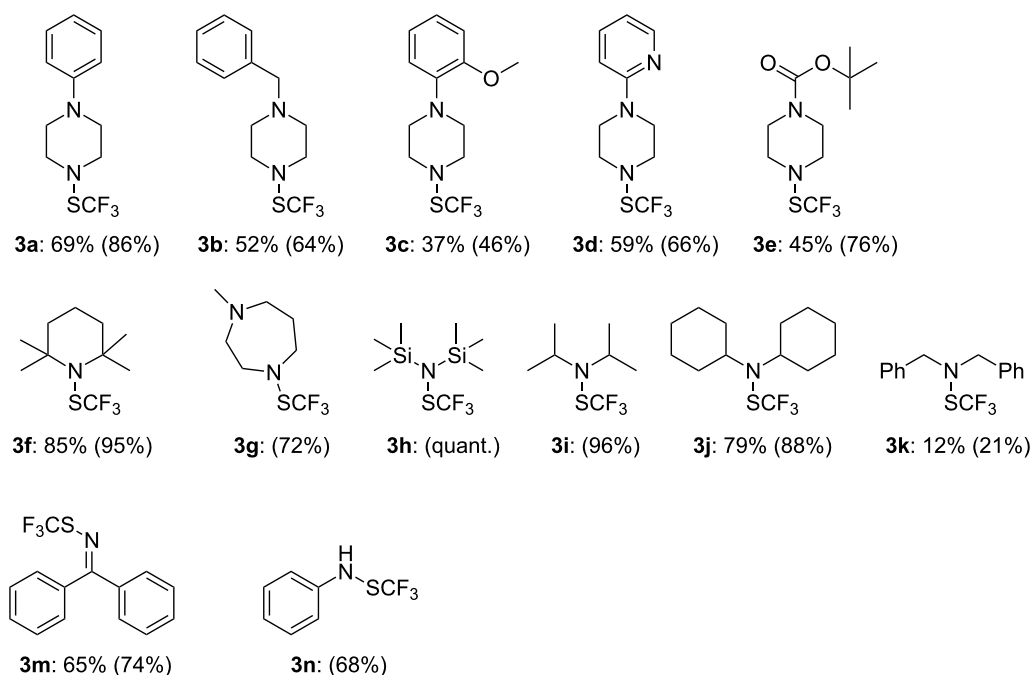

Figure 1: Transamination of **1a** with amines. (Isolated yields, in parentheses crude yields determined by ¹⁹F NMR with PhOCF₃ as an internal standard).

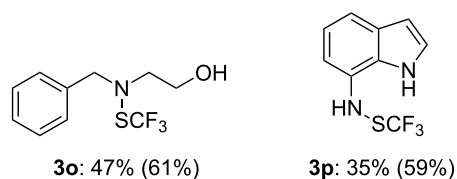

Figure 2: Reaction of **1a** with bis-nucleophiles. (Isolated yields, in parentheses crude yields determined by ^{19}F NMR with PhOCF_3 as an internal standard).

This new method was applied to synthesize a trifluoromethylthio analog (**3i**) of the well-known tricyclic antidepressant imipramine (Figure 3). Since the pentafluoroethyl analog **1b** of reagent **1a** has also been described previously, a pentafluoroethylthio analog of imipramine was synthesized (**4i**) (Figure 3). In the latter case, the obtained yield was lower, certainly due to the steric hindrance of the $\text{CF}_3\text{CF}_2\text{S}$ moiety. The pharmacological properties of these new compounds are under investigation.

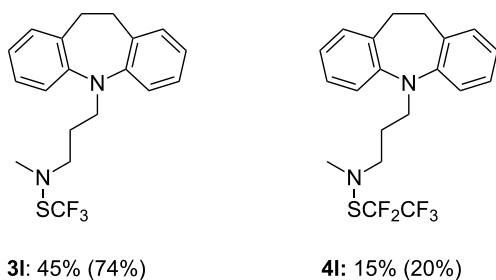

Figure 3: Synthesis of fluoroalkylthio analogs of imipramine. (Isolated yields, in parentheses crude yields determined by ^{19}F NMR with PhOCF_3 as an internal standard).

Conclusion

In conclusion, the trifluoromethanesulfenamide **1a** is a very efficient reagent for the electrophilic trifluoromethylthiolation which can also react with amines to open a new access to trifluoromethylsulfanyl amines. These compounds belong to a new class of products which may exhibit interesting properties for further applications – in particular in medicinal chemistry – owing to the characteristics of the CF_3SN moiety.

Supporting Information

Supporting Information File 1

Experimental procedure.

[<http://www.beilstein-journals.org/bjoc/content/supplementary/1860-5397-9-270-S1.pdf>]

Acknowledgements

We thank the CNRS for their financial support. The French Fluorine Network is also thanked for its support.

References

- Ojima, I. *Fluorine in Medicinal Chemistry and Chemical Biology*; Wiley: Chichester, 2009. doi:10.1002/9781444312096
- Dunitz, J. D. *ChemBioChem* **2004**, *5*, 614–621. doi:10.1002/cbic.200300801
- Biffinger, J. C.; Kim, H. W.; DiMagno, S. G. *ChemBioChem* **2004**, *5*, 622–627. doi:10.1002/cbic.200300910
- Becker, A. *Inventory of Industrial Fluoro-biochemicals*; Eyrolles: Paris, 1996.
- Jeschke, P. *ChemBioChem* **2004**, *5*, 570–589. doi:10.1002/cbic.200300833
- Müller, K.; Faeh, C.; Diederich, F. *Science* **2007**, *317*, 1881–1886. doi:10.1126/science.1131943
- Purser, S.; Moore, P. R.; Swallow, S.; Gouverneur, V. *Chem. Soc. Rev.* **2008**, *37*, 320–330. doi:10.1039/b610213c
- Hagmann, W. K. *J. Med. Chem.* **2008**, *51*, 4359–4369. doi:10.1021/jm800219f
- Bégué, J.-P.; Bonnet-Delpon, D. *Bioorganic and Medicinal Chemistry of Fluorine*; John Wiley & Sons, Inc.: Hoboken, 2008. doi:10.1002/9780470281895
- Hansch, C.; Leo, A.; Taft, R. W. *Chem. Rev.* **1991**, *91*, 165–195. doi:10.1021/cr00002a004
- Langlois, B. R.; Billard, T.; Large, S.; Roques, N. *Potentially bioactive CF_3S - and $\text{CF}_3\text{S(O)}$ -substituted compounds. Fluorinated Bioactive Compounds in the Agricultural & Medical Fields*; Chemical & Polymer: Cheshire, 1999; 24/1–24/8.
- Szmuszkovicz, J.; Glenn, E. M.; Heinzelman, R. V.; Hester, J. B., Jr.; Youngdale, G. A. *J. Med. Chem.* **1966**, *9*, 527–536. doi:10.1021/jm00322a020
- Cherkofsky, S. C. Antiinflammatory 4,5-diaryl-2-(substituted-thio)pyrroles and their corresponding sulfoxides and sulfones. U.S. Patent US4267184A, May 12, 1981.
- Davies, P.; Doherty, J. B.; Finke, P. E.; Humes, J. L.; Leudke, E. S.; Maccoss, M.; Mumford, R. A.; Shah, S. K. Substituted azetidinones useful in the treatment of leukemia. Brit. Patent GB2266527A, March 11, 1993.
- Dorn, C. P.; Finke, P. E.; Maccoss, M.; Doherty, J. B.; Shah, S. K.; Hagmann, W. K. Preparation of substituted azetidinones as anti-inflammatory and antidegenerative agents. Eur. Pat. EP0481671A1, April 22, 1992.
- Firestone, R. A.; Barker, P. L.; Pisano, J. M.; Ashe, B. M.; Dahlgren, M. E. *Tetrahedron* **1990**, *46*, 2255–2262. doi:10.1016/S0040-4020(01)82006-8
- Nakayama, M.; Yamada, M. Sulfonamide derivative-containing agricultural and horticultural compositions. WO Patent WO2002054867A1, July 18, 2002.
- Sahu, K. K.; Ravichandran, V.; Mourya, V. K.; Agrawal, R. K. *Med. Chem. Res.* **2007**, *15*, 418–430. doi:10.1007/s00044-006-0020-2
- Schallner, O.; Schwarz, H.-G.; Hoischen, D.; Linker, K.-H.; Drewes, M. W.; Dahmen, P.; Feucht, D.; Pontzen, R. Preparation of benzoxazinones and related compounds as herbicides. WO Patent WO2002006277A1, Jan 24, 2002.
- Tabuchi, T.; Yamamoto, T.; Nakayama, M. Preparation of aryl- or heterocyclisulfonamide derivatives as agricultural and horticultural microbicides. WO Patent WO2000065913A1, Nov 1, 2000.

21. Ferry, A. New reactivity of DAST and its analogs: Synthesis and applications of fluorinated sulfinamidines and sulfanylamines. Ph.D. Thesis, University of Lyon, Lyon, France, 2007.
22. Borowski, H. E.; Haas, A. *Chem. Ber.* **1982**, *115*, 523–532. doi:10.1002/cber.19821150215
23. Ceacareanu, D. M.; Gerstenberger, M. R. C.; Haas, A. *Chem. Ber.* **1983**, *116*, 3325–3331. doi:10.1002/cber.19831161008
24. Geisel, M.; Mews, R. *Chem. Ber.* **1987**, *120*, 1675–1677. doi:10.1002/cber.19871201011
25. Gerstenberger, M. R. C.; Haas, A.; Wille, R.; Yazdanbaksch, M. *Rev. Chim. Miner.* **1986**, *23*, 485–496.
26. Gupta, O. D.; Kamil, W. A.; Shreeve, J. M. *Inorg. Chem.* **1985**, *24*, 2126–2129. doi:10.1021/ic00208a004
27. Haas, A.; Lieb, M. *J. Heterocycl. Chem.* **1986**, *23*, 1079–1084. doi:10.1002/jhet.5570230423
28. Haas, A.; Lieb, M.; Schwederski, B. *Rev. Roum. Chim.* **1987**, *32*, 1219–1224.
29. Kolasa, A.; Lieb, M. *J. Fluorine Chem.* **1995**, *70*, 45–47. doi:10.1016/0022-1139(94)03086-F
30. Kost, D.; Egozy, H. *J. Org. Chem.* **1989**, *54*, 4909–4913. doi:10.1021/jo00281a038
31. Munavalli, S.; Rohrbaugh, D. K.; Rossman, D. I.; Berg, F. J.; Wagner, G. W.; Durst, H. D. *Synth. Commun.* **2000**, *30*, 2847–2854. doi:10.1080/00397910008087435
32. Munavalli, S.; Rohrbaugh, D. K.; Rossman, D. I.; Durst, H. D. *Phosphorus, Sulfur Silicon Relat. Elem.* **2002**, *177*, 1109–1116. doi:10.1080/10426500211704
33. Munavalli, S.; Rohrbaugh, D. K.; Rossman, D. I.; Wagner, W. G.; Durst, H. D. *Phosphorus, Sulfur Silicon Relat. Elem.* **2003**, *178*, 107–113. doi:10.1080/10426500307779
34. Peach, M. E. *Can. J. Chem.* **1967**, *45*, 429–432. doi:10.1139/v67-076
35. Yagupol'skii, L. M.; Bezdudnyi, A. V.; Yagupol'skii, Yu. L. *Russ. J. Org. Chem.* **2006**, *42*, 1275–1279. doi:10.1134/S1070428006090041
36. Various nomenclatures have been used for these compounds in previous publications, including our own. According to the IUPAC rules it appears that the true name must be trifluoromethanesulfenamide. Alternatively, trifluoromethylsulfanylamine could be used.
37. Ferry, A.; Billard, T.; Langlois, B. R.; Bacqué, E. *J. Org. Chem.* **2008**, *73*, 9362–9365. doi:10.1021/jo8018544
38. Baert, F.; Colomb, J.; Billard, T. *Angew. Chem.* **2012**, *124*, 10528–10531. doi:10.1002/ange.201205156
Angew. Chem., Int. Ed. **2012**, *51*, 10382–10385. doi:10.1002/anie.201205156
39. Ferry, A.; Billard, T.; Bacqué, E.; Langlois, B. R. *J. Fluorine Chem.* **2012**, *134*, 160–163. doi:10.1016/j.jfluchem.2011.02.005
40. Ferry, A.; Billard, T.; Langlois, B. R.; Bacqué, E. *Angew. Chem.* **2009**, *121*, 8703–8707. doi:10.1002/ange.200903387
Angew. Chem., Int. Ed. **2009**, *48*, 8551–8555. doi:10.1002/anie.200903387
41. Liu, J.; Chu, L.; Qing, F.-L. *Org. Lett.* **2013**, *15*, 894–897. doi:10.1021/ol400032g
42. Tlili, A.; Billard, T. *Angew. Chem.* **2013**, *125*, 6952–6954. doi:10.1002/ange.201301438
Angew. Chem., Int. Ed. **2013**, *52*, 6818–6819. doi:10.1002/anie.201301438
43. Yang, Y.; Jiang, X.; Qing, F.-L. *J. Org. Chem.* **2012**, *77*, 7538–7547. doi:10.1021/jo3013385
44. Alazet, S.; Zimmer, L.; Billard, T. *Angew. Chem.* **2013**, *125*, 11014–11017. doi:10.1002/ange.201305179
Angew. Chem., Int. Ed. **2013**, *52*, 10814–10817. doi:10.1002/anie.201305179

License and Terms

This is an Open Access article under the terms of the Creative Commons Attribution License (<http://creativecommons.org/licenses/by/2.0>), which permits unrestricted use, distribution, and reproduction in any medium, provided the original work is properly cited.

The license is subject to the *Beilstein Journal of Organic Chemistry* terms and conditions: (<http://www.beilstein-journals.org/bjoc>)

The definitive version of this article is the electronic one which can be found at: [doi:10.3762/bjoc.9.270](https://doi.org/10.3762/bjoc.9.270)

Crystal design using multipolar electrostatic interactions: A concept study for organic electronics

Peer Kirsch*, Qiong Tong and Harald Untenecker

Full Research Paper

Open Access

Address:
Merck KGaA, Liquid Crystal R&D Chemistry, Frankfurter Str. 250,
D-64392 Darmstadt, Germany, Tel: (+49)6151-72-41118, Fax:
(+49)6151-72-2593

Email:
Peer Kirsch* - peer.kirsch@merckgroup.com

* Corresponding author

Keywords:
aromatic stacking; charge carrier transport; crystal design;
electrostatic control; organic semiconductor; organo-fluorine

Beilstein J. Org. Chem. **2013**, *9*, 2367–2373.
doi:10.3762/bjoc.9.272

Received: 28 June 2013
Accepted: 15 October 2013
Published: 05 November 2013

This article is part of the Thematic Series "Organo-fluorine chemistry III".

Guest Editor: D. O'Hagan

© 2013 Kirsch et al; licensee Beilstein-Institut.
License and terms: see end of document.

Abstract

Using a simple synthetic protocol, heterohexacene analogues with a quadrupolar distribution of partial charges are readily available. In contrast to most other acenes, these compounds crystallize with a slipped-stack, brickwork-like packing which is mainly controlled by electrostatic interactions. This type of packing offers an advantage for organic semiconductors, because it allows more isotropic charge transport compared to the "herring bone" stacking observed for other acenes.

Introduction

Within a very few years the first organic semiconductors have found practical application in printed circuits for driving e-paper displays [1,2]. Among the most critical parameters for their application in organic field effect transistors (OFET) are their charge carrier mobility and their solubility in non-toxic organic solvents for processing by printing techniques [3]. High charge carrier mobilities are a particularly critical prerequisite for application in backplanes for OLED displays.

The highest charge carrier mobilities in organic compounds have so far been reported for single crystals of small molecules [4], the "classics" among them being acenes such as pentacene [5], which act as *p*-type semiconductors. However, acenes in the crystalline state tend to form slightly tilted molecular stacks

("herring bone" pattern), which is resulting in a strong directional anisotropy for the charge carrier mobility along the stacking direction. Charge carrier transport in organic materials, or electron transport in general, occurs in most cases by a hopping mechanism which is described by the Marcus theory [6].

$$k_{\text{et}} = \frac{2\pi}{\hbar} |H_{\text{AB}}|^2 \frac{1}{\sqrt{4\pi\lambda k_{\text{b}}T}} \exp\left(-\frac{\lambda}{4k_{\text{b}}T}\right) \quad (1)$$

According to Marcus' formula (1), the rate of electron transfer (k_{et}) between equal molecules is controlled by the electronic overlap (transfer integral H) between the donating and the

receiving orbital, which is very sensitive to intermolecular distance and relative orientation [7]. The second parameter determining the charge transfer rate is the reorganization energy (λ), required to accommodate the newly charged or discharged molecule within the crystal lattice. Charge carrier mobility can be optimized by minimizing the reorganization energy and by maximizing the transfer integral. Low reorganization energies are generally realized very well by the higher acenes, due to their wide charge delocalization and their small differences in geometry between the neutral species and the charged radical.

However, the stacked crystal structure found in acenes in general results in an extremely one-dimensional directionality of charge transport within the single stacks with its inherent vulnerability towards even minor structural defects. Thus, the experimentally observed charge carrier mobilities, e.g., in pentacene based OFETs, remain far below the theoretically predicted limit of several tens of $\text{cm}^2 \cdot \text{V}^{-1} \text{s}^{-1}$ [8]. In order to overcome this obstacle, it would be ideal to have acene-like organic semiconductors which pack in the crystal not in one-dimensional stacks but in a brickwork-like pattern with two-dimensional overlap. This has been very efficiently realized by Anthony et al. for pentacene derivatives by attaching sterically demanding trialkylsilylacetylene moieties to the central ring, forcing the crystal into a brick-like arrangement (Figure 1) [9]. However, the price to pay for this optimized morphology is the presence of bulky silyl groups which do not electronically contribute to the charge transport.

For this reason we set out to execute an alternative concept to achieve a brick-like, slipped stacking in planar, acene-based organic semiconductors. In contrast to Anthony's approach of

steric interference with the formation of one-dimensional stacks, our approach is based on "sculpting" the electrostatic potential surface of the semiconductor molecule in a way that cofacial stacking leads to electrostatic repulsion which can be converted into attraction by sliding the π -systems against each other by about half a molecular length. The advantage of this concept is not only a brick-like 2D structure, but also supposedly a tighter packing with smaller interplanar distances due to the strong electrostatic interactions. A similar effect has been demonstrated by Watson et al. [10] with bipolar, partially fluorinated aromatic compounds, which form closely packed 1D stacks through self-complementary structure of their electrostatic potential surface.

Chemically, the electrostatic potential surface can be modelled very efficiently with partially fluorinated arenes, without expanding the geometry too much. Arene-perfluoroarene interactions are well known to stabilize molecular crystals [11–13] through multipolar electrostatic interactions, and there are a few examples for their use in organic electronics [10,14]. Another point to consider are the HOMO and LUMO energy levels, which have to be consistent with the work function of electrode materials used in OFETs – typically gold with a work function of around -5.4 eV. Taking this into account, the semifluorinated tetraoxatetrahydrohexacene **1** was selected as synthetic target for our concept study, with a predicted [15] HOMO energy of -5.64 eV and LUMO of -1.29 eV (Figure 2).

Results and Discussion

Synthesis and structural characterization

The synthesis of model compound **1** is extremely simple: octa-fluoronaphthalene (**2**) [16–18] is reacted with catechol in the

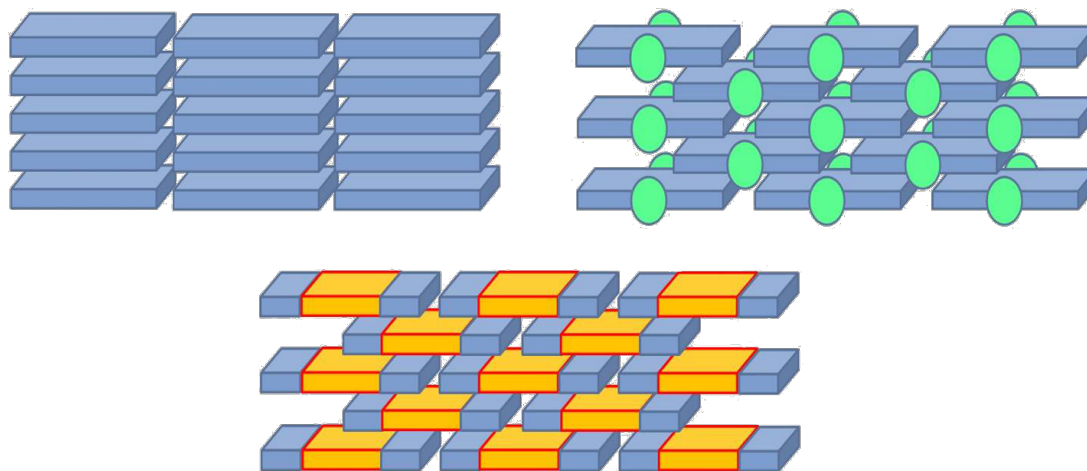
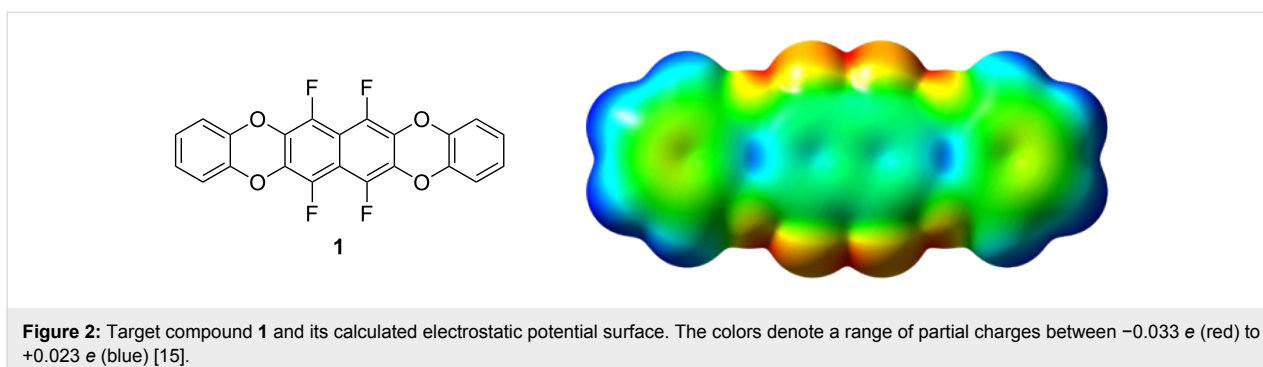

Figure 1: Schematic view of the different types of molecular arrangements in acene-based molecular semiconductors: "herringbone" stacking (upper left) vs sterically induced slipped stack, "brick-like" TIPS-pentacenes (upper right, the green spheres denote sterically demanding lateral groups) vs electrostatically induced slipped stack concept (bottom, the different colors denote opposite partial charges on the electrostatic potential surface).



presence of potassium carbonate (Scheme 1). Under relatively mild conditions (THF, 60 °C, 4 h) only the *mono*-substitution product **3** is formed, whereas at a higher temperature (DMEU, 90 °C, 18 h) the target compound **1** is furnished in moderate yield. The solubility of **1** in all common organic solvents was found to be extremely poor and impeded the purification as well as the analytical characterization. Attempts to purify the material by sublimation resulted only in its decomposition.

It is well known, that octafluoronaphthalene (**2**) reacts quite selectively towards nucleophilic attack [16-18]. Under mild reaction conditions normally the fluorine atom at the 2-position is replaced first, followed by the fluorine atom at the 7-position. If the temperature is raised, the fluorine atoms at the 3- and the 6-positions are substituted next. This selectivity can be explained by an analysis of the partial charge distribution in **2** [15]. The carbon atoms at the 2-, 3-, 6- and 7-positions carry positive partial charges of $+0.508 e$, whereas the *peri*-carbons are much less positive with only $+0.276 e$. This renders the *peri*-position less susceptible to the charge-controlled attack by hard nucleophiles.

In spite of the extremely poor solubility of **1** in all usual organic solvents, small crystals suitable for X-ray structure analysis were obtained by very slow room temperature crystallization from THF. The quality of the crystals was borderline poor, but it was possible to gather data for a sufficiently accurate picture of the packing pattern of the compound (Figure 3).

The packing of **1** shows two dominant features: one is the slipped-stack motif of the arenes with an average interplanar distance of 363 pm. The slippage is not exactly half a period as intended, but slightly more. However, it clearly reflects the quadrupolar pattern of charge distribution on the surface of **1**. The other feature are laterally interlocking sheets with close contacts between electropositive hydrogen and electronegative fluorine ($H\cdots F$ 260.6 pm) and oxygen ($H\cdots O$ 279.1 pm). In contrast to most other acenes, such as hexacene [19], the stacks are only very slightly tilted around their long axis (only ca. 5.2° relative to the sheet plane) (Figure 4).

The reason why **1** does not display the acene-typical herringbone arrangement appears to be the distribution of the electrostatic potentials dominating the packing completely. However, a drawback of the electrostatically controlled crystal packing is the very poor solubility of **1**.

Theoretical study on electronic properties

In order to explore the potential utility of **1** and its analogues as an organic semiconductor, the transfer integrals [20,21] for hole and electron transfer between the four closest pairs of molecules were calculated (Figure 5).

The analysis shows that particularly the hole transfer proceeds predominantly through the π -faces (mainly pair **A**), limiting the charge carrier transport to the π -stacked "brick wall". For electron transport the pair **D** allows additional charge transfer

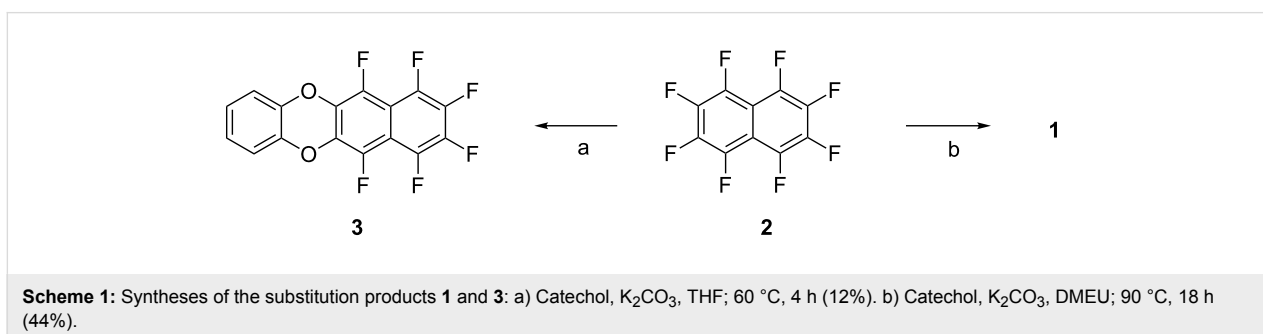

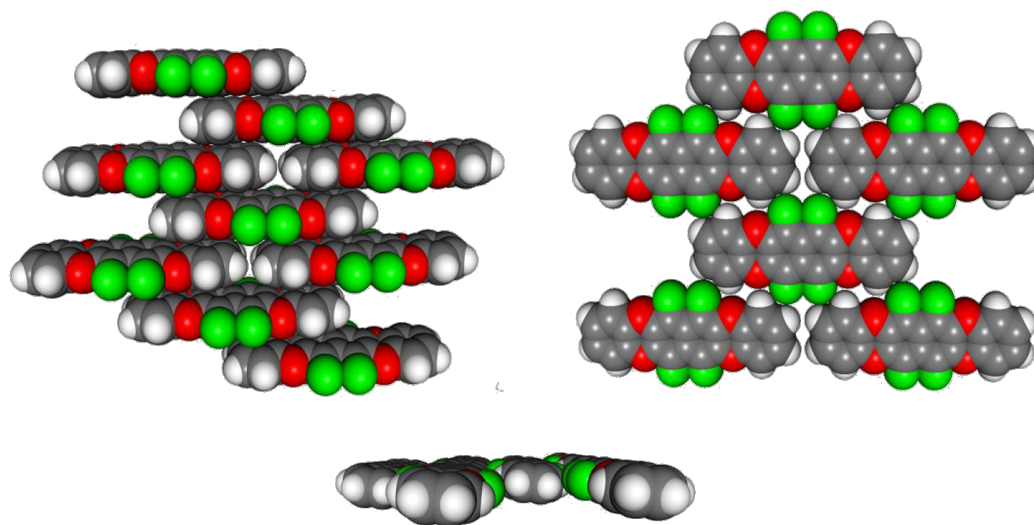

Figure 3: The crystal structure of **1** is characterized by brick wall-like stacks (left), which are arranged in sheets (right). Within the sheets the molecules are nearly parallel, slightly tilted along their long axis by ca. 5.2° (bottom).

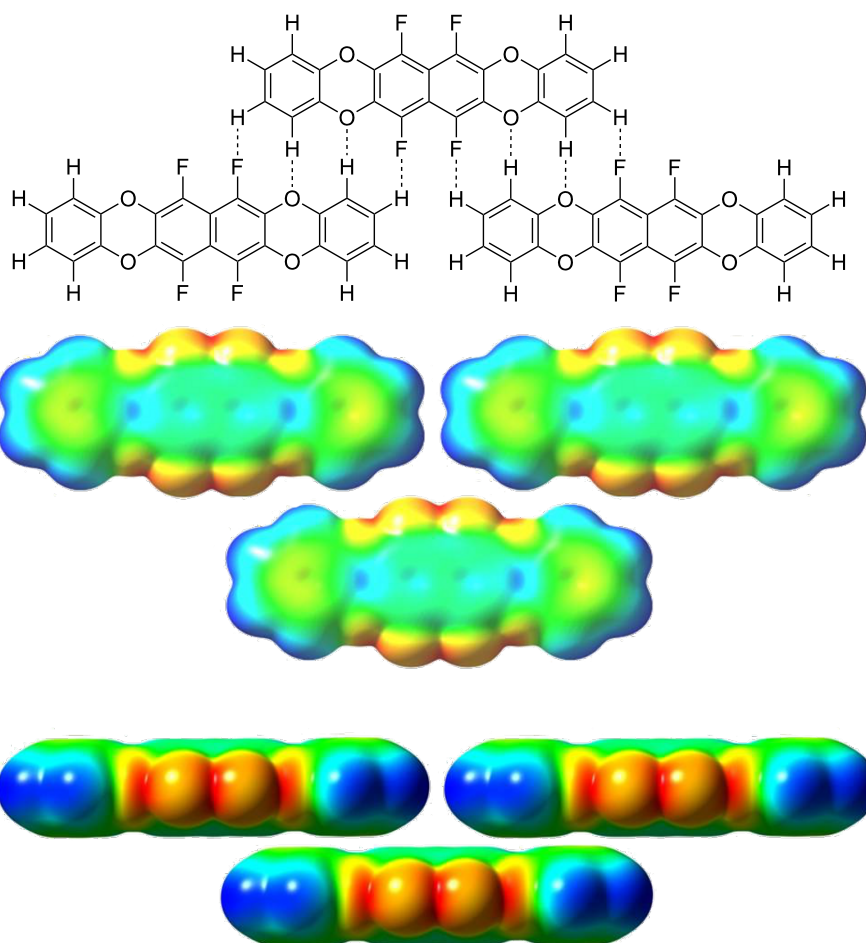
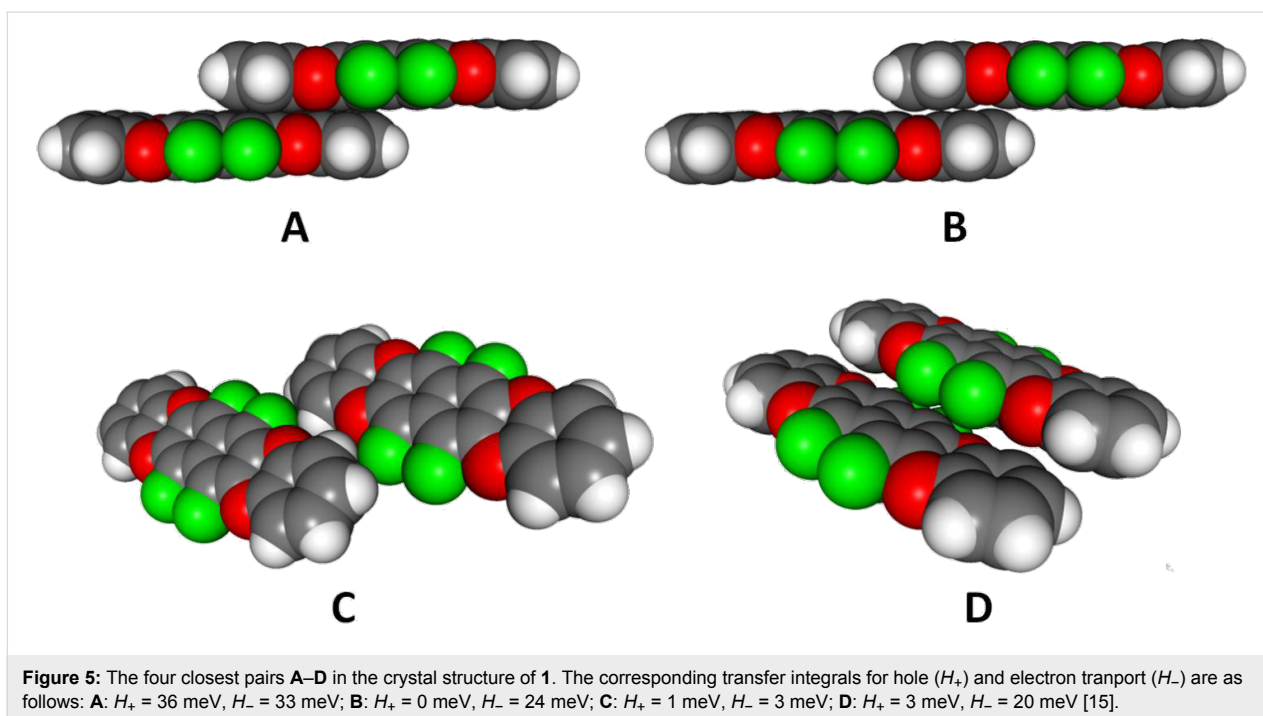

Figure 4: The electrostatic factors determining the packing of **1**. The laterally interlinked sheets are stabilized by dipolar $\text{H}\cdots\text{O}$ and $\text{H}\cdots\text{F}$ bridges. The inter-plane arrangement is dominated by the complementary quadrupolar, partial charge distribution on the surface of **1**.



between adjoining "walls". This difference between hole and electron transfer can be explained by the geometries of the HOMO and LUMO orbitals (Figure 6) and their different modes of overlap in the arrangements A–D. Whereas the HOMO is all over the aromatic part of **1**, the LUMO is more contracted to the central naphthalene unit, but extends also to the four fluorine substituents. This is probably the reason for the significant lateral electron mobility between the adjoining "brick walls" in contrast to the hole mobility which is limited to one contact (A) with particularly strong π – π overlap.

In conclusion, **1** can be considered predominantly as a highly anisotropic 1D conductor for holes, but as a quite isotropic 3D conductor for electrons.

Conclusion

The fluorinated tetraoxatetrahydrohexacene derivative **1** was synthesized in an extremely simple, one-step procedure from octafluoronaphthalene and catechol. Due to the quadrupolar

distribution of partial charges, the compound does not crystallize with the herring bone packing typical for other acenes. It forms a brickwork-like assembly of the aromatic units, which is laterally integrated into a structure of interlocked sheets, stabilized by spatial and electrostatic H \cdots F and H \cdots O contacts. The calculation of transfer integrals based on the crystal structure indicates that in spite of the brickwall-structure, due to a slight asymmetry of the "layering", the hole conductivity is rather anisotropic (1D), whereas the electron conductivity is three-dimensional (3D). Although the control of the crystal packing by "sculpting" the electrostatic potential surface is demonstrated impressively, also the drawback of the concept becomes visible: the same intermolecular electrostatic forces which shape and stabilize the crystal packing cause extremely poor solubility and processability.

Experimental

General remarks: Reagents and solvents were obtained commercially and used as supplied. ^1H and ^{19}F NMR spectra

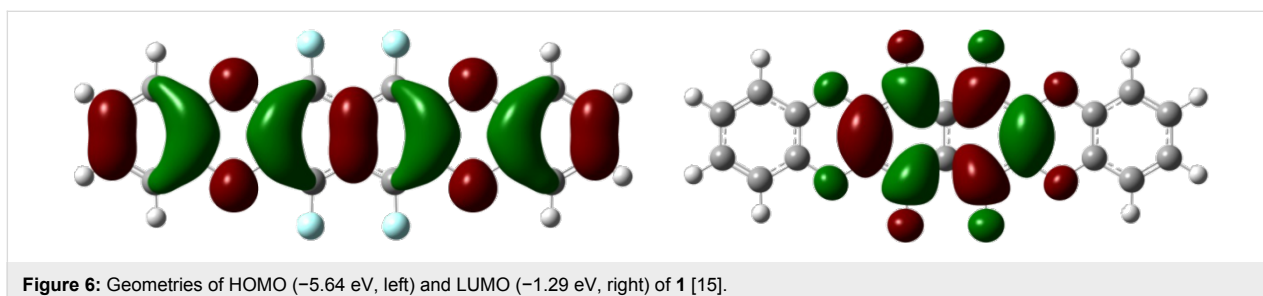

were collected using a Bruker Avance 400 spectrometer. ^1H NMR chemical shifts were referenced to the solvent signal. GC–MS experiments were performed on an Agilent 7890A system equipped with a 7000A Triple Quad detector. Melting points were determined by differential scanning calorimetry (DSC) performed on a Universal V4.5A (TA Instruments) at a heating/cooling rate of $20\text{ K}\cdot\text{min}^{-1}$. The temperature was calibrated with indium. The measurements were performed under a nitrogen atmosphere. X-ray diffraction measurements were carried out with a SuperNova (Agilent) diffractometer.

Synthesis of 6,7,8,9,10,11-hexafluorobenzo[*b*]oxanthrene (3):

A solution of octafluoronaphthalene (**2**, 340 mg, 1.2 mmol) in THF (10 mL) was added dropwise to the suspension of catechol (0.26 g, 2.4 mmol) and potassium carbonate (410 mg, 2.9 mmol) in THF (30 mL) at $60\text{ }^\circ\text{C}$. After complete addition, the reaction mixture was stirred at $60\text{ }^\circ\text{C}$ for another 4 hours. The reaction mixture was allowed to cool down to room temperature and filtrated. The solid residue was washed repeatedly with THF, and the filtrate was evaporated to dryness in vacuo. The remaining crude product was purified by recrystallization from isopropanol/THF (2:3) solvent mixture. After drying in vacuo for 18 hours the product was obtained as colourless crystalline solid. Yield: 46 mg (12%) of colorless crystals, mp $258\text{ }^\circ\text{C}$. ^1H NMR (400.1 MHz, THF- d_8) δ 7.15–7.06 (m, 4H); ^{19}F NMR (376.4 MHz, THF- d_8) δ -148.23 to -148.39 (m, $^4J_{\text{FF}} = 61\text{ Hz}$, 2F), -148.80 to -149.01 (m, $^4J_{\text{FF}} = 61\text{ Hz}$, $^3J_{\text{FF}} = 15\text{ Hz}$, 2F), -159.61 to -159.65 (m, $^3J_{\text{FF}} = 15\text{ Hz}$, 2F); MS (HPLC–APLI) m/z (%): 342 $[\text{M}]^+$ (100); HRMS (ASAP–MS, $100\text{--}500\text{ }^\circ\text{C}$, $\text{C}_{22}\text{H}_8\text{O}_4\text{F}_4$): calcd 412.0358798; found, 412.03517; Single crystals for the X-ray structure analysis were obtained by slow crystallization from THF. Crystal structure data for **1** ($\text{C}_{22}\text{H}_8\text{F}_4\text{O}_4$): crystal size $0.0909 \times 0.045 \times 0.0297\text{ mm}$, triclinic, $P\bar{1}$, $a = 6.0570(9)\text{ \AA}$, $b = 7.6382(12)\text{ \AA}$, $c = 8.829(3)\text{ \AA}$, $\alpha = 94.98(2)^\circ$, $\beta = 97.72(2)^\circ$, $\gamma = 101.372(13)^\circ$, $V = 394.11(16)\text{ \AA}^3$, $Z = 1$, $\rho_{\text{calcd}} = 1.737\text{ g}\cdot\text{cm}^{-3}$, $R(F) = 5.94\%$ for 754 observed independent reflections ($5.09^\circ \leq 2\theta \leq 50.36^\circ$). Crystallographic data for the structure reported in this paper have been deposited at the Cambridge Crystallographic Data Centre as supplementary publication No. CCDC-947860. Copies of the data can be obtained free of charge on application to CCDC, 12 Union Road, Cambridge CB2 1EZ, UK (fax: (+44) 1223-336-033; e-mail: deposit@ccdc.cam.ac.uk; <http://www.ccdc.cam.ac.uk/>).

Synthesis of 6,7,14,15-tetrafluorooxanthreno[2,3-*b*]oxanthrene (1):

A solution of octafluoronaphthalene (**2**, 340 mg, 1.2 mmol) in 1,3-dimethylimidazolidinone (DMEU, 5 mL) was added dropwise to the suspension of catechol (0.26 g, 2.4 mmol) and potassium carbonate (630 mg, 4.3 mmol) in DMEU (15 mL) at $90\text{ }^\circ\text{C}$. The reaction mixture was stirred at 90

$^\circ\text{C}$ for 18 hours. After completion of the reaction, the reaction mixture was cooled down to room temperature and poured into a mixture of ice and water. The precipitated crude product was filtrated and purified by recrystallization from benzonitrile. After drying in vacuo for 18 hours the product was obtained as white crystalline solid. Yield: 190 mg (44%) of colorless crystals, mp $302\text{ }^\circ\text{C}$. The solubility in THF- d_8 and other suitable solvents was not sufficient for obtaining meaningful solution NMR spectra. MS (HPLC–APLI) m/z (%): 412 $[\text{M}]^+$ (100).

Acknowledgements

The authors gratefully acknowledge A. Ruhl for technical assistance, and Prof. I. Krossing and Dr. A. Kraft for their support with the crystallization of **1** and helpful discussions.

References

- Heikenfeld, J.; Drzaic, P.; Yeo, J. S.; Koch, T. *J. Soc. Inf. Disp.* **2011**, *19*, 129–136.
- Plastic Logic Ltd. <http://www.plasticlogic.com> (accessed June 12, 2013).
- Loo, Y.-L. *AIChE J.* **2007**, *53*, 1066–1074. doi:10.1002/aic.11151
- Anthony, J. E. *Angew. Chem., Int. Ed.* **2008**, *47*, 452–483. doi:10.1002/anie.200604045
- Takeya, J.; Goldmann, C.; Haas, S.; Pernstich, K. P.; Ketterer, B.; Batlogg, B. *J. Appl. Phys.* **2003**, *94*, 5800–5804. doi:10.1063/1.1618919
- Marcus, R. A. *Angew. Chem.* **1993**, *105*, 1161–1172. doi:10.1002/ange.19931050804
Angew. Chem., Int. Ed. Engl. **1993**, *32*, 1111–1121. doi:10.1002/anie.199311113
- Feng, X.; Marcon, V.; Pisula, W.; Hansen, M. R.; Kirkpatrick, J.; Grozema, F.; Andrienko, D.; Kremer, K.; Müllen, K. *Nat. Mater.* **2009**, *8*, 421–426. doi:10.1038/nmat2427
- Butko, V. Y.; Chi, X.; Lang, D. V.; Ramirez, A. P. *Appl. Phys. Lett.* **2003**, *83*, 4773–4775. doi:10.1063/1.1631736
- Anthony, J. E.; Brooks, J. S.; Eaton, D. L.; Parkin, S. R. *J. Am. Chem. Soc.* **2001**, *123*, 9482–9483. doi:10.1021/ja0162459
- Cho, D. M.; Parkin, S. R.; Watson, M. D. *Org. Lett.* **2005**, *7*, 1067–1068. doi:10.1021/ol050019c
- Williams, J. H.; Cockcroft, J. K.; Fitch, A. N. *Angew. Chem.* **1992**, *104*, 1666–1669. doi:10.1002/ange.19921041230
Angew. Chem., Int. Ed. Engl. **1992**, *31*, 1655–1657. doi:10.1002/anie.199216551
- Ganguly, P.; Desiraju, G. R. *CrystEngComm* **2010**, *12*, 817–833. doi:10.1039/b910915c
- Reichenbacher, K.; Süß, H. I.; Hulliger, J. *Chem. Soc. Rev.* **2005**, *34*, 22–30. doi:10.1039/B406892K
- Okamoto, T.; Nakahara, K.; Saeki, A.; Seki, S.; Oh, J. H.; Akkerman, H. B.; Bao, Z.; Matsuo, Y. *Chem. Mater.* **2011**, *23*, 1646–1649. doi:10.1021/cm200356y
- Gaussian 03*, Revision E.01; Gaussian, Inc.: Wallingford, CT, 2004. The transfer integrals were calculated on the B3LYP/6-311+G(2,d,p) level of theory.
- Chambers, R. D.; Seabury, M. J.; Williams, D. L. H.; Hughes, N. *J. Chem. Soc., Perkin Trans. 1* **1988**, 251–254. doi:10.1039/P19880000251

17. Kirsch, A. Ph.D. Thesis, University of Heidelberg, Heidelberg, Germany, 1993.
18. Kirsch, P. *Modern Fluoroorganic Chemistry*, 2nd ed.; Wiley-VCH: Weinheim, Germany, 2013; p 59. doi:10.1002/9783527651351
19. Watanabe, M.; Chang, Y. J.; Liu, S.-W.; Chao, T.-H.; Goto, K.; Islam, M. M.; Yuan, C.-H.; Tao, Y.-T.; Shinmyozu, T.; Chow, T. J. *Nat. Chem.* **2012**, *4*, 574–578. doi:10.1038/nchem.1381
20. Brédas, J.-L.; Beljonne, D.; Coropceanu, V.; Cornil, J. *Chem. Rev.* **2004**, *104*, 4971–5004. doi:10.1021/cr040084k
21. Coropceanu, V.; Cornil, J.; da Silva Filho, D. A.; Olivier, Y.; Silbey, R.; Brédas, J.-L. *Chem. Rev.* **2007**, *107*, 926–952. doi:10.1021/cr050140x

License and Terms

This is an Open Access article under the terms of the Creative Commons Attribution License (<http://creativecommons.org/licenses/by/2.0>), which permits unrestricted use, distribution, and reproduction in any medium, provided the original work is properly cited.

The license is subject to the *Beilstein Journal of Organic Chemistry* terms and conditions: (<http://www.beilstein-journals.org/bjoc>)

The definitive version of this article is the electronic one which can be found at:
[doi:10.3762/bjoc.9.272](https://doi.org/10.3762/bjoc.9.272)

A one-pot synthesis of 3-trifluoromethyl-2-isoxazolines from trifluoromethyl aldoxime

Raoni S. B. Gonçalves, Michael Dos Santos, Guillaume Bernadat, Danièle Bonnet-Delpon and Benoit Crousse*

Full Research Paper

Open Access

Address:
BioCIS CNRS, Faculté de Pharmacie, Labex-LERMIT, Univ Paris Sud, 5 rue J. B. Clément, 92290 Châtenay-Malabry, France

Email:
Benoit Crousse* - Benoit.crousse@u-psud.fr

* Corresponding author

Keywords:
aldoxime; amino alcohol; fluorine; isoxazole; isoxazoline; organo-fluorine

Beilstein J. Org. Chem. **2013**, *9*, 2387–2394.
doi:10.3762/bjoc.9.275

Received: 19 July 2013
Accepted: 08 October 2013
Published: 07 November 2013

This article is part of the Thematic Series "Organo-fluorine chemistry III".

Guest Editor: D. O'Hagan

© 2013 Gonçalves et al; licensee Beilstein-Institut.
License and terms: see end of document.

Abstract

Functionalized 3-trifluoromethyl-2-isoxazolines and 3-trifluoromethylisoxazoles were easily prepared from trifluoromethyl aldoxime **2** under mild conditions by using DIB as oxidant. Theoretical studies of the reactivity of trifluoroacetonitrile oxide **4** toward olefins and alkynes were carried out. The 3-trifluoromethyl-2-isoxazolines were ring-opened with NaBH₄ and NiCl₂ to yield the corresponding trifluoromethylated γ -amino alcohols.

Introduction

2-Isloxazolines are five-membered heterocyclic compounds that have been widely applied in medicinal and organic chemistry. This nucleus is frequently found in natural products [1-4], bioactive molecules [5,6] (Figure 1) and can be used as bioisosteric transformations of amide bonds in order to provide metabolically stable and more active derivatives [7-11]. Moreover, 2-isloxazolines can be cleaved under various conditions to supply a variety of organic functionalities including γ -amino alcohols [12], β -amino acids [13], β -hydroxy ketones [14,15] and β -hydroxy nitriles [14,15].

Fluorinated compounds play a central role in different branches of chemistry [16]. The incorporation of a fluorine atom into bioactive molecules causes remarkable changes of their

physicochemical properties, which allows the development of substances with improved pharmacological characteristics. Some examples are the synthesis of modified amino acids and peptides, carbohydrates, natural products and the development of more selective enzyme inhibitors [17-21]. Another powerful area, yet a somewhat less utilised role for fluorine is as a tag for ¹⁹F NMR that offers several analytical advantages including speed, sensitivity and selectivity [22,23]. Fluorinated molecules have served as valuable ¹⁹F NMR probes in high-throughput screening, drug metabolism and protein binding experiments as well as in assessing gene expression [24].

Nevertheless, the preparation of 3-trifluoromethyl-2-isoxazolines **1** has not been extensively studied so far. In the literature

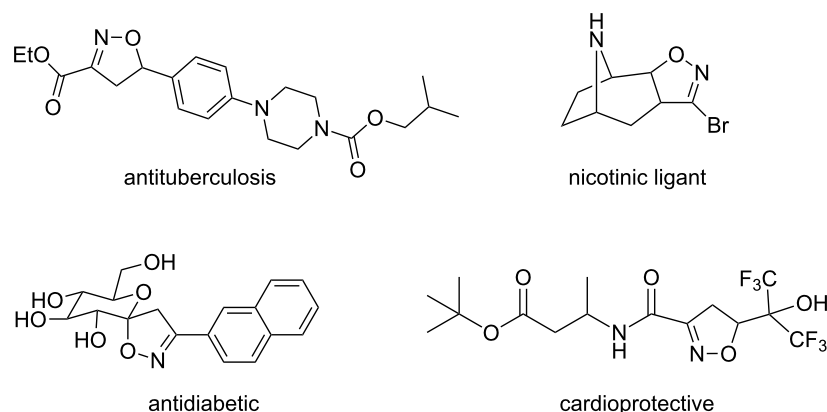

Figure 1: Example of bioactive molecules bearing the 2-isoxazoline nucleus.

only a few examples of the preparation of these derivatives through a multistep procedure are described (Scheme 1) [25]. Initially, trifluoromethyl aldoxime **2** is halogenated to give a volatile trifluoroacetylhydroxymoyl chloride or bromide **3**, which is usually isolated in low yields. Reaction of intermediate **3** with a base provides trifluoroacetonitrile oxide **4**, which can be reacted with olefins (such as styrene, allyl derivatives, etc.) through a 1,3-dipolar cycloaddition to give the desired product. Therefore, the development of a straightforward and mild general procedure to access these valuable derivatives remains of great importance. In the present work, we describe a simple and efficient metal-free protocol for the oxidation of trifluoromethyl aldoxime **2** into trifluoroacetonitrile oxide **4** and a one-pot synthesis of **1** through in situ cyclization of **4** with different dipolarophiles (Scheme 1).

Results and Discussion

Initially, another procedure for the preparation of the trifluoroacetaldehyde oxime **2** was developed. In a previous work [25], **2** was obtained as an etherate complex from the reaction

between 2,2,2-trifluoroethane-1,1-diol (TFAL) and hydroxylamine hydrochloride. In our work, reaction of TFAL and an aqueous solution of hydroxylamine (50 wt %) yielded the desired product, which was isolated as a complex of two molecules of aldoxime with one molecule of water after distillation in 70–80% yield (Scheme 2).

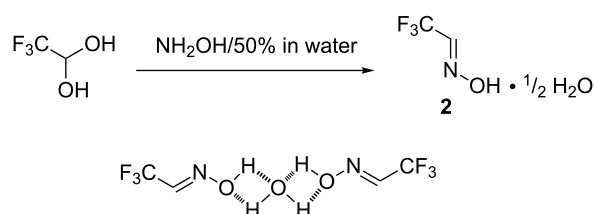

Scheme 2: Synthesis of aldoxime **2**.

In the recent literature, different conditions have been developed for the direct oxidation of aldoximes [26–31]. Recently, commercially available reagents have been employed under

previous work:

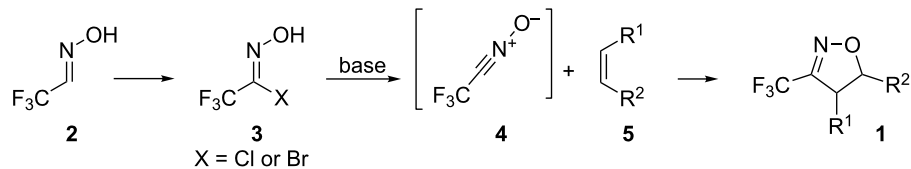

this work:

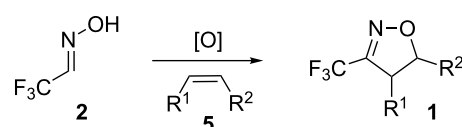

Scheme 1: Synthesis of 3-trifluoromethyl-2-isoxazolines.

metal-free conditions. A group [27] reported that the hypervalent iodine reagents (diacetoxyiodo)benzene (DIB) and phenyliodine bis(trifluoroacetate) (PIFA) could successfully promote the oxidation of aldoximes to the corresponding nitrile oxide. Those reagents exhibit potent oxidizing properties, comparable to heavy-metal reagents, but with several advantages such as low toxicity, high availability and the possibility to be utilized under mild conditions [32]. Then, we decided to verify their applicability in the oxidation of **2** despite the presence of water. We first screened different oxidative reagents and conditions for the oxidation step and allylbenzene (**5a**) was chosen as dipolarophile. Our studies for this process are summarized in Table 1.

Table 1: Effect of different conditions on the reaction between trifluoromethyl aldoxime **2** and allylbenzene (**5a**).

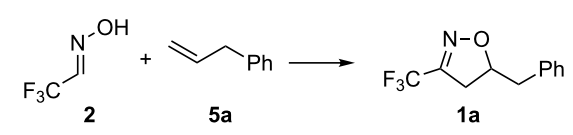

entry	reaction conditions	time	isolated yield (%)
1	DIB, TEA, MeOH	2 h	complex mixture
2	DIB, HFIP	2 h	complex mixture
3	DIB, CH ₂ Cl ₂	overnight	55
4	PIFA, CH ₂ Cl ₂	overnight	16

When DIB was used with triethylamine (TEA) and methanol as solvent, the formation of a complex mixture was observed (Table 1, entry 1). This is probably due to the nucleophilic addition of methanol to the highly electrophilic trifluoroacetonitrile oxide. The utilization of the less nucleophilic alcohol hexafluoroisopropanol (HFIP) [33,34] led to the formation of a complex mixture (Table 1, entry 2). The oxidation of **2** with PIFA in CH₂Cl₂ afforded the product in only 16% yield (Table 1, entry 4). Better results were obtained by employing DIB in CH₂Cl₂ as solvent, after which the product could be isolated in an acceptable yield (55%, Table 1, entry 3). [Bis(acetoxy)iodo]benzene (DIB) is a weaker oxidant than PIFA. When the oxidation is carried out with DIB, weak acetic acid instead of strong trifluoroacetic acid is liberated, and the decomposition of the oxazolines is avoided.

Faced with the moderate yield of **1a**, we followed the reaction by using ¹⁹F NMR. The measurement of the crude mixture with ¹⁹F NMR revealed the presence of a side product and despite the total consumption of the aldoxime, a small amount of allylbenzene remained. It is known that nitrile oxides can dimerize or isomerize to yield different products, such as furoxans, isocyanates, 1,2,4-oxadiazoles and 1,4,2,5-dioxadiazines (Figure 2).

We thus postulated that a competition between the cycloaddition reaction and the dimerization or isomerization pathways could occur. Aiming to confirm our hypothesis we carried out the reaction without the presence of allylbenzene. After 12 h, **2** was completely consumed with the exclusive formation of the previously observed side product. However, attempts to isolate this product failed due to its high volatility. It was therefore co-distilled with CH₂Cl₂ and the resulted solution was analyzed by ¹⁹F NMR coupled and decoupled with proton, ¹⁹F, ¹⁹F-COSY and ¹⁹F, ¹⁹F-NOESY (see Supporting Information File 1). Data confirmed the formation of bis(trifluoromethyl)furoxan **6** (Figure 3) already synthesized by Middleton [35].

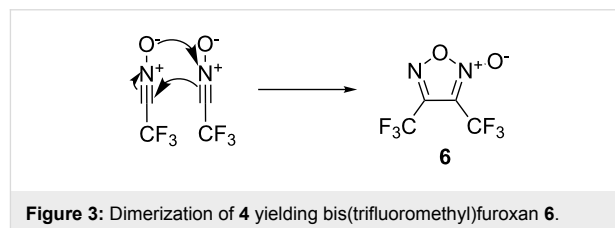

Considering that the best results were reached utilizing DIB and CH₂Cl₂ as solvent, these conditions were selected for further optimizations. After several investigations, we could verify that employing two equivalents of aldoxime **2** and two equivalents of DIB led to complete conversion of the starting olefin. The product could be isolated in good yield (76%, see below in Table 2, entry 1). We can note here that water complexed with **2** did not alter the reaction rate.

Having optimized reagents and conditions, the scope of the reaction was explored with regard to the substrates (Table 2). As observed in the earliest works [11], the cycloaddition of **4**

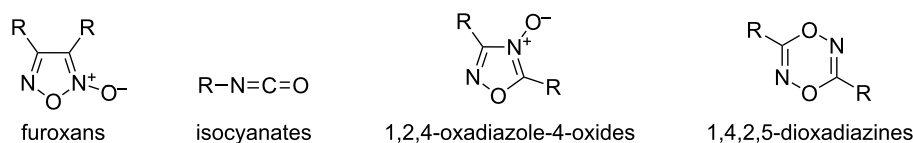
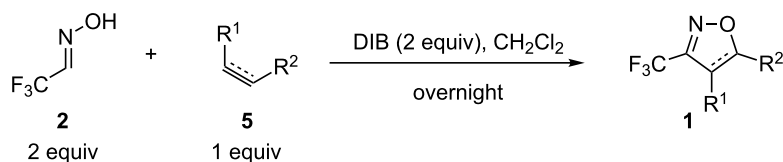

Figure 2: Dimerization and isomerization products from nitrile oxides.

with terminal olefins led to the corresponding 3-trifluoromethyl-5-substituted-2-isoxazoline **1** with complete regioselectivity. No trace of the regioisomer 3-trifluoromethyl-4-substituted-2-isoxazoline could be detected even when yields of cycloadducts were low. From functionalized olefins such as NH-Cbz and NH-Boc allylamines the desired product could be





isolated in excellent yields (90% and 91%, respectively, Table 2, entries 2 and 3). Interestingly, the protecting groups were not cleaved, which indicated that reaction conditions are very mild. With allyltrimethylsilane oxazoline **1g** was obtained in good yield (82%). From ester and acid derivatives of undecen, isoxazolines were obtained in good yields too (64%

Table 2: Synthesis of 3-trifluoromethyl-2-isoxazolines and isoxazoles by reaction between aldoxime **2** and olefins or alkynes in the presence of DIB.

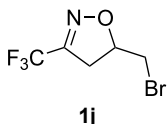

entry	substrate	product	isolated yield (%)
1			76
2			90
3			91
4			64
5			51
6			56
7			82
8			74
9			24

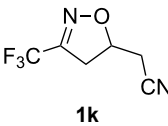
Table 2: Synthesis of 3-trifluoromethyl-2-isoxazolines and isoxazoles by reaction between aldoxime **2** and olefins or alkynes in the presence of DIB. (continued)

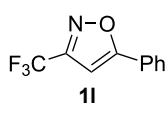
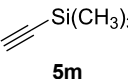
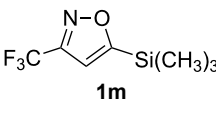
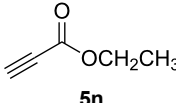
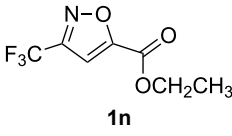
10			20
11			traces
12			53
13			50
14			traces

and 51%, respectively, Table 2, entries 4 and 5). With *para*-bromostyrene isoxazoline **1f** was obtained in 56% yield. On the other hand, a good yield was reached for disubstituted olefin **5h** (Table 2, entry 8). However a complete lack of reactivity was observed for the reaction with the electron-poor olefins **5i**, **5j** and **5k** (Table 2, entries 9–11). The reaction was also carried out with alkynes, providing 3-trifluoromethyl-5-substituted-isoxazoles. Moderate yields were obtained for the reaction with phenylacetylene (**5l**) and trimethylsilylacetylene (**5m**, Table 2, entries 12 and 13). However, the electron poor alkyne **5n** was unreactive towards trifluoroacetonitrile oxide **4**.

1,3-Dipolar cycloaddition reactions have been studied from the theoretical standpoint since the 1970's onwards [36,37] with an ever-increasing accuracy as computational methods evolved [38]. Assuming that the above-mentioned transformations occur via a concerted mechanism, we decided to perform electronic structure calculations at the B3LYP/6-31G* level in order to further understand the reactivity of the different unsaturated compounds studied in this work against trifluoroacetonitrile oxide **4** (See Supporting Information File 1) [39–43]. Upon energy minimization, a structure with a geometry close to linearity was found for trifluoroacetonitrile oxide (Figure 4), which is consistent with earlier findings [44].

Comparison of the energy gaps between the frontier molecular orbital levels of the nitrile oxide and those of the alkene partners (Figure 5) suggest that type-III cycloaddition reactions (where the dipole reacts via its LUMO and the dipolarophile via

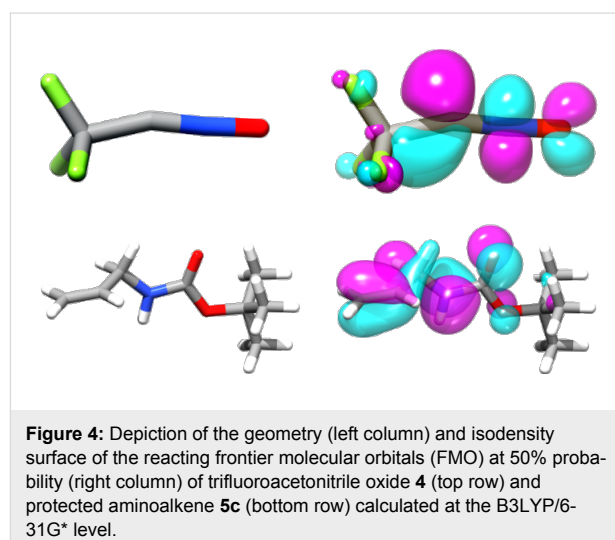

its HOMO) take place for every combination of reactants reported herein [45].

In this scenario, with the same dipole, the reactivity is expected to increase with the HOMO energy level of the dipolarophile. A simple scatter plot of yield versus the latter variable confirms and illustrates this trend (Figure 6), which can be interpreted the following way: when the gap between the LUMO energy level of the nitrile oxide and the HOMO energy level of the alkene becomes too high (relatively to 7.139 eV, which is the energy difference for the self-cycloaddition process), the dimerization pathway is favored and the yield of isoxazole drops.

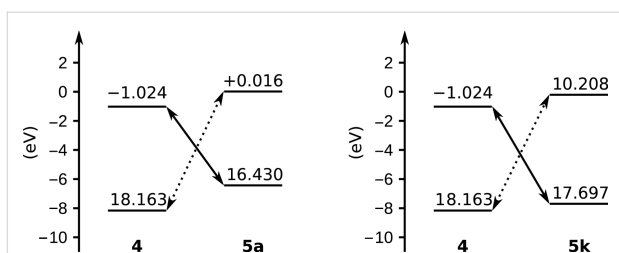

Figure 5: FMO energy levels of dipole **4** and dipolarophiles **5a** and **5k** calculated at the B3LYP/6-31G* level. Continuous and dotted lines indicate the favored ($\Delta E = 5.407$ eV for **5a** and 6.673 eV for **5k**) and the disfavored ($\Delta E = 8.178$ eV for **5a** and 7.955 eV for **5k**) molecular orbital interactions, respectively.

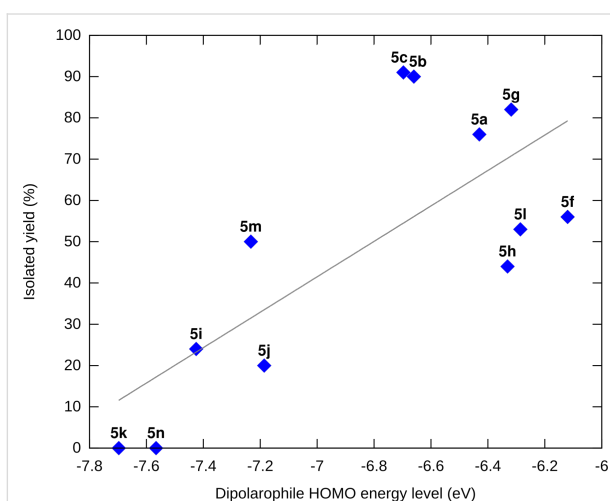

Figure 6: Yields of the cycloaddition reaction plotted against the HOMO energy levels of the dipolarophile partner among **5a-c, f-n**.

With only a single regioisomer being isolated, we also considered the coefficients (Table 3) and shapes (Figure 4) of frontier molecular orbitals. This data is compatible with the observed

regioselectivity [37]. Steric factors can also exert notable influence, but they would guide regioselectivity in the same direction.

Table 3: FMO coefficients of the 1,3-dipole **4** and representative dipolarophiles (atomic orbital is indicated in parentheses).

reactant	coefficients	
	C_a	C_b
5c	0.180 ($2p_y$)	0.133 ($2p_x$)
5g	0.321 ($2p_z$)	0.246 ($2p_z$)
4^a	0.434 ($2p_y$)	0.299 ($2p_y$)

^aColumns C_a and C_b contain coefficients for C and O.

In a subsequent step, we decided to preliminarily study the ring opening reaction of the 3-trifluoromethyl-2-isoxazolines in order to prepare the corresponding trifluoromethylated γ -amino alcohols. The major and almost the only route to synthesize these amino alcohols is the reduction of β -aminocarbonyl compounds prepared from Mannich-type reactions [46–48]. The ring opening of 2-methyl-3-trifluoromethylisoxazolines by utilizing H_2 and Raney-Ni as catalysts was described by Tanaka and co-workers [49]. However, this methodology is restricted to the synthesis of *N*-methylated amino alcohols. Instead we investigated the reduction and the ring opening of 3-trifluoromethyl-2-isoxazolines **1a** and **1b** in the presence of $NaBH_4$ and $NiCl_2$ as additives [50]. Under these conditions, a total conversion of the starting material was observed by ^{19}F NMR, and products **7a** and **7b** were obtained in moderate yields. However the diastereoisomeric excess was very poor (10% de). The results are reported in Table 4.

Table 4: Ring opening reaction of 3-trifluoromethyl-2-isoxazolines **1a** and **1b**.

entry	substrate	product	isolated yield (%)	dr
1	 1a	 7a	50	40:60
2	 1b	 7b	52	40:60

Conclusion

In conclusion, we have developed a simple, mild and efficient one-step procedure for the synthesis of functionalized 3-trifluoromethyl-2-isoxazolines and 3-trifluoromethyl-2-isoxazoles from trifluoromethyl aldoxime **2** by utilizing DIB as oxidant. The applicability of the 3-trifluoromethyl-2-isoxazolines to supply different fluorinated building blocks was demonstrated by the easy ring opening of these intermediates with NaBH₄ and NiCl₂, yielding the corresponding trifluoromethylated γ -amino alcohol.

Supporting Information

Supporting Information File 1

General methods, synthetic procedure, spectroscopic data, ¹H NMR, ¹³C NMR and ¹⁹F NMR of compounds of **2**, **1a-1j**, **1l-1n**, **7a**, **7b**, **6** and computational results.
[<http://www.beilstein-journals.org/bjoc/content/supplementary/1860-5397-9-275-S1.pdf>]

Acknowledgements

R.S.B.G thanks the FAPERJ, CNPq, the Marie Curie program, the Farmaguinhos/FioCruz, and PGQu for financial support. Central Glass Co. Ltd. is gratefully acknowledged for kindly providing fluoral hydrate and HFIP, as well as the IT department from Université Paris-Sud for providing computing resources. The authors would like thank M'bokeno Gomes Lowa, Erasmus student. We also thank the French Fluorine Network (GIS Fluor).

References

- Feuer, H., Ed. *Nitrile oxides, nitrones, and nitronates in organic synthesis*, 2nd ed.; John Wiley & Sons: Hoboken, NJ, 2008.
- Cicchi, S.; Cordero, F. M.; Giomi, D. Five-membered ring systems: With O&N atoms. In *Progress in Heterocyclic Chemistry*; Gribble, G. W.; Joule, J. A., Eds.; Pergamon: Oxford, 2003; Vol. 15, pp 261–283.
- Namboothiri, I. N. N.; Rastogi, N. Isoxazolines from Nitro Compounds: Synthesis and Applications. In *Synthesis of Heterocycles via Cycloadditions I*; Gupta, R. R.; Hassner, A., Eds.; Springer: Berlin, 2008; Vol. 12, pp 1–44. doi:10.1007/7081_2007_101
- Savage, G. P. *Curr. Org. Chem.* **2010**, *14*, 1478–1499. doi:10.2174/138527210791616812
- El Sayed, K. A.; Bartyzel, P.; Shen, X.; Perry, T. L.; Zjawiony, J. K.; Hamann, M. T. *Tetrahedron* **2000**, *56*, 949–953. doi:10.1016/S0040-4020(99)01093-5
- Proksch, P.; Putz, A.; Ortlepp, S.; Kjer, J.; Bayer, M. *Phytochem. Rev.* **2010**, *9*, 475–489. doi:10.1007/s11101-010-9178-9
- Castellano, S.; Kuck, D.; Viviano, M.; Yoo, J.; López-Vallejo, F.; Conti, P.; Tamborini, L.; Pinto, A.; Medina-Franco, J. L.; Sbardella, G. *J. Med. Chem.* **2011**, *54*, 7663–7677. doi:10.1021/jm2010404
- Dallanocce, C.; Frigerio, F.; Martelli, G.; Grazioso, G.; Matera, C.; Pomè, D. Y.; Pucci, L.; Clementi, F.; Gotti, C.; De Amici, M. *Bioorg. Med. Chem.* **2010**, *18*, 4498–4508. doi:10.1016/j.bmc.2010.04.065
- Cheng, J.-F.; Huang, Y.; Penuliar, R.; Nishimoto, M.; Liu, L.; Arrhenius, T.; Yang, G.; O'Leary, E.; Barbosa, M.; Barr, R.; Dyck, J. R. B.; Lopaschuk, G. D.; Nadzan, A. M. *J. Med. Chem.* **2006**, *49*, 4055–4058. doi:10.1021/jm0605029
- Bentlifa, M.; Hayes, J. M.; Vidal, S.; Gueyrard, D.; Goekjian, P. G.; Praly, J.-P.; Kizilis, G.; Tiraidis, C.; Alexacou, K.-M.; Chrysina, E. D.; Zographos, S. E.; Leonidas, D. D.; Archontis, G.; Oikonomakos, N. G. *Bioorg. Med. Chem.* **2009**, *17*, 7368–7380. doi:10.1016/j.bmc.2009.08.060
- Rakesh; Sun, D.; Lee, R. B.; Tangallapally, R. P.; Lee, R. E. *Eur. J. Med. Chem.* **2009**, *44*, 460–472. doi:10.1016/j.ejmech.2008.04.007
- Tangallapally, R. P.; Sun, D.; Rakesh; Budha, N.; Lee, R. E. B.; Lenaerts, A. J.; Meibohm, B.; Lee, R. E. *Bioorg. Med. Chem. Lett.* **2007**, *17*, 6638–6642. doi:10.1016/j.bmlcl.2007.09.048
- Tang, S.; He, J.; Sun, Y.; He, L.; She, X. *J. Org. Chem.* **2010**, *75*, 1961–1966. doi:10.1021/jo1000065
- Jiang, D.; Chen, Y. *J. Org. Chem.* **2008**, *73*, 9181–9183. doi:10.1021/jo801831c
- Maimone, T. J.; Shi, J.; Ashida, S.; Baran, P. S. *J. Am. Chem. Soc.* **2009**, *131*, 17066–17067. doi:10.1021/ja908194b
- Chambers, R. D. *Fluorine in Organic Chemistry*; Blackwell Publishing Ltd.: Oxford, 2004. doi:10.1002/9781444305371
- O'Hagan, D. *Chem. Soc. Rev.* **2008**, *37*, 308–319. doi:10.1039/b711844a
- Bégué, J.-P.; Bonnet-Delpon, D. *Bioorganic and Medicinal Chemistry of Fluorine*; Wiley: Hoboken, 2008. doi:10.1002/9780470281895
- Uneyama, K. *Organofluorine Chemistry*; Blackwell Publishing: Oxford, 2006. doi:10.1002/9780470988589
- Kirsch, P. *Modern Fluoroorganic Chemistry*; Wiley: Weinheim, Germany, 2004. doi:10.1002/352760393X
- Banks, R. E.; Smart, B. E.; Tatlow, J. C. *Organofluorine Chemistry, Principles and Commercial Applications*; Plenum: New York, 1994.
- Woods, J. R.; Mo, H.; Bieberich, A. A.; Alavanja, T.; Colby, D. A. *J. Med. Chem.* **2011**, *54*, 7934–7941. doi:10.1021/jm201114t
- Jordan, J. B.; Poppe, L.; Xia, X.; Cheng, A. C.; Sun, Y.; Michelsen, K.; Eastwood, H.; Schnier, P. D.; Nixey, T.; Zhong, W. *J. Med. Chem.* **2012**, *55*, 678–687. doi:10.1021/jm201441k
- Dalvit, C. *Prog. Nucl. Magn. Reson. Spectrosc.* **2007**, *51*, 243–271. doi:10.1016/j.pnmrs.2007.07.002
- Tanaka, K.; Masuda, H.; Mitsuhashi, K. *Bull. Chem. Soc. Jpn.* **1984**, *57*, 2184–2187. doi:10.1246/bcsj.57.2184
- Yoshimura, A.; Zhu, C.; Middleton, K. R.; Todora, A. D.; Kastern, B. J.; Maskaev, A. V.; Zhdankin, V. V. *Chem. Commun.* **2013**, *49*, 4800–4802. doi:10.1039/c3cc41164h
- Mendelsohn, B. A.; Lee, S.; Kim, S.; Teyssier, F.; Aulakh, V. S.; Ciufolini, M. A. *Org. Lett.* **2009**, *11*, 1539–1542. doi:10.1021/ol900194v
- Shing, T. K. M.; Wong, W. F.; Cheng, H. M.; Kwok, W. S.; So, K. H. *Org. Lett.* **2007**, *9*, 753–756. doi:10.1021/ol062873p
- Singh, V.; Hutait, S.; Biswas, S.; Batra, S. *Eur. J. Org. Chem.* **2010**, 531–539. doi:10.1002/ejoc.200901166
- Pinto, A.; Conti, P.; Grazioso, G.; Tamborini, L.; Madsen, U.; Nielsen, B.; De Micheli, C. *Eur. J. Med. Chem.* **2011**, *46*, 787–793. doi:10.1016/j.ejmech.2010.12.020
- Minakata, S.; Okumura, S.; Nagamachi, T.; Takeda, Y. *Org. Lett.* **2011**, *13*, 2966–2969. doi:10.1021/ol2010616

32. Zhdankin, V. V.; Stang, P. J. *Chem. Rev.* **2008**, *108*, 5299–5358. doi:10.1021/cr800332c
33. Bégué, J.-P.; Bonnet-Delpon, D.; Crousse, B. *Synlett* **2004**, 18–29. doi:10.1055/s-2003-44973
34. Shuklov, I. A.; Dubrovina, N. V.; Börner, A. *Synthesis* **2007**, 2925–2943. doi:10.1055/s-2007-983902
35. Middleton, W. J. *J. Org. Chem.* **1984**, *49*, 919–922. doi:10.1021/jo00179a031
36. Houk, K. N.; Sims, J.; Duke, R. E.; Strozier, R. W.; George, J. K. *J. Am. Chem. Soc.* **1973**, *95*, 7287–7301. doi:10.1021/ja00803a017
37. Houk, K. N.; Sims, J.; Watts, C. R.; Luskus, L. J. *J. Am. Chem. Soc.* **1973**, *95*, 7301–7315. doi:10.1021/ja00803a018
38. Lan, Y.; Zou, L.; Cao, Y.; Houk, K. N. *J. Phys. Chem. A* **2011**, *115*, 13906–13920. doi:10.1021/jp207563h
39. Kohn, W.; Sham, L. J. *Phys. Rev.* **1965**, *140*, A1133–A1138. doi:10.1103/PhysRev.140.A1133
40. Hohenberg, P.; Kohn, W. *Phys. Rev.* **1964**, *136*, B864–B871. doi:10.1103/PhysRev.136.B864
41. Becke, A. D. *J. Chem. Phys.* **1993**, *98*, 5648–5652. doi:10.1063/1.464913
42. Lee, C.; Yang, W.; Parr, R. G. *Phys. Rev. B* **1988**, *37*, 785–789. doi:10.1103/PhysRevB.37.785
43. Hehre, W. J.; Radom, L.; Schleyer, P. V. R.; Pople, J. *Ab Initio Molecular Orbital Theory*; Wiley: New York, 1986.
44. Havasi, B.; Pasinszki, T.; Westwood, N. P. C. *J. Phys. Chem. A* **2005**, *109*, 3864–3874. doi:10.1021/jp040725f
45. Sustmann, R. *Pure Appl. Chem.* **1974**, *40*, 569–593. doi:10.1351/pac197440040569
46. Michaut, V.; Metz, F.; Paris, J.-M.; Plaquevent, J.-C. *J. Fluorine Chem.* **2007**, *128*, 889–895. doi:10.1016/j.jfluchem.2007.03.007
47. Sukach, V. A.; Golovach, N. M.; Pirozhenko, V. V.; Rusanov, E. B.; Vovk, M. V. *Tetrahedron: Asymmetry* **2008**, *19*, 761–764. doi:10.1016/j.tetasy.2008.02.023
48. Huguenot, F.; Brigaud, T. *J. Org. Chem.* **2006**, *71*, 2159–2162. doi:10.1021/jo052323p
49. Tanaka, K.; Sugimoto, Y.; Okafuji, Y.; Tachikawa, M.; Mitsuhashi, K. *J. Heterocycl. Chem.* **1989**, *26*, 381–385. doi:10.1002/jhet.5570260221
50. Nonn, M.; Kiss, L.; Sillanpää, R.; Fülöp, F. *Beilstein J. Org. Chem.* **2012**, *8*, 100–106. doi:10.3762/bjoc.8.10

License and Terms

This is an Open Access article under the terms of the Creative Commons Attribution License (<http://creativecommons.org/licenses/by/2.0>), which permits unrestricted use, distribution, and reproduction in any medium, provided the original work is properly cited.

The license is subject to the *Beilstein Journal of Organic Chemistry* terms and conditions:

(<http://www.beilstein-journals.org/bjoc>)

The definitive version of this article is the electronic one which can be found at:

doi:10.3762/bjoc.9.275

Cu-catalyzed trifluoromethylation of aryl iodides with trifluoromethylzinc reagent prepared in situ from trifluoromethyl iodide

Yuzo Nakamura, Motohiro Fujiu, Tatsuya Murase, Yoshimitsu Itoh, Hiroki Serizawa, Kohsuke Aikawa and Koichi Mikami*

Letter

Open Access

Address:
Department of Applied Chemistry, Graduate School of Science and Engineering, Tokyo Institute of Technology, 2-12-1-H-113 O-okayama, Meguro-ku, Tokyo 152-8552, Japan

Email:
Koichi Mikami* - mikami.k.ab@m.titech.ac.jp

* Corresponding author

Keywords:
organo-fluorine; Ruppert–Prakash reagent; trifluoromethyl; trifluoromethylation; trifluoromethyl zinc

Beilstein J. Org. Chem. **2013**, *9*, 2404–2409.
doi:10.3762/bjoc.9.277

Received: 02 September 2013
Accepted: 10 October 2013
Published: 08 November 2013

This article is part of the Thematic Series "Organo-fluorine chemistry III" and is dedicated to the memory of the late Professor Nobuo Ishikawa on the occasion of his 23rd Kai-Ki.

Guest Editor: D. O'Hagan

© 2013 Nakamura et al; licensee Beilstein-Institut.
License and terms: see end of document.

Abstract

The trifluoromethylation of aryl iodides catalyzed by copper(I) salt with trifluoromethylzinc reagent prepared in situ from trifluoromethyl iodide and Zn dust was accomplished. The catalytic reactions proceeded under mild reaction conditions, providing the corresponding aromatic trifluoromethylated products in moderate to high yields. The advantage of this method is that additives such as metal fluoride (MF), which are indispensable to activate silyl groups for transmetallation in the corresponding reactions catalyzed by copper salt by using the Ruppert–Prakash reagents (CF₃SiR₃), are not required.

Introduction

Organo-fluorine compounds have received considerable attention in the fields of biomedical chemistry, agrochemistry, and organic material science due to their unique chemical, biological, and physical properties [1-6]. Particularly, trifluoromethylated compounds can be widely employed as one of the most effective analogues of bioactive compounds, because the trifluoromethyl group enhances the metabolic stability, lipophilicity, and bioavailability of these compounds [7]. As a

result, trifluoromethylated compounds have been efficiently synthesized by both building-block methods which employ trifluoromethylated substrates and direct methods which employ trifluoromethyl reagents [7-9]. However, a nucleophilic trifluoromethylation by trifluoromethyl organometallic reagents such as lithium and magnesium, which are widely utilized in non-fluorine organic synthesis, cannot be used. These trifluoromethyl metal reagents are generally too unstable to prepare

even at low temperature because of facile α -fluoro elimination generating the singlet difluoromethylene ($:\text{CF}_2$) [10]. In contrast, trifluoromethylsilyl counterparts, so-called Ruppert–Prakash reagents (CF_3SiR_3), are highly stable, but reactive in the presence of fluoride, and hence the most versatile nucleophilic trifluoromethyl reagents [11,12]. The trifluoromethylzinc reagent ($\text{Zn}(\text{CF}_3)\text{Br}\cdot 2\text{DMF}$), a stable solid, can also be used for the trifluoromethylation of aryl iodides, while stoichiometric amounts of copper(I) bromide are required to afford the more reactive trifluoromethyl copper (CuCF_3) species by transmetalation [13,14]. However, these reagents are generally prepared from trifluoromethyl bromide (CF_3Br), whose production is now prohibited because of the ozone depleting effect [15]. On the other hand, the trifluoromethylzinc reagent ($\text{Zn}(\text{CF}_3)\text{I}$) formed in situ from trifluoromethyl iodide (CF_3I) as an alternative trifluoromethyl source is utilized for trifluoromethylation reactions [10,16]. The preparation of the reagent followed by the reactions, however, requires ultrasonic irradiation and thus lacks reproducibility [16]. Therefore, the direct and reproducible preparation of the trifluoromethylzinc reagent and its application to trifluoromethylation reactions pose a particular challenge. Recently, Daugulis and co-workers reported the trifluoromethylation of aryl iodide catalyzed by copper(I) chloride with $\text{Zn}(\text{CF}_3)_2$ prepared in situ from TMP_2Zn and fluoroform (CHF_3), but only

one substrate was investigated to provide the trifluoromethylated product only in a moderate yield [17]. As described above, much of the area of catalytic trifluoromethylations with trifluoromethylzinc reagent has not been explored yet, compared to the area of catalytic trifluoromethylations with the Ruppert–Prakash reagents [7,11,12,18–21]. Herein, we report the trifluoromethylations of aryl iodides catalyzed by copper(I) salt with trifluoromethylzinc reagent prepared in situ from CF_3I and Zn dust. The trifluoromethylated aromatic products are privileged skeletal key compounds in pharmaceutical science as shown in Mefloquine (Lariam[®]), Fluoxetine (Prozac[®]), Leflunomide (Arava[®]), Celecoxib (Celebrex[®]), Bicalutamide (Casodex[®]), Aprepitant (Emend[®]), and Nilutamide (Nilandron[®]).

Results and Discussion

The preparation of the trifluoromethylzinc reagent $\text{Zn}(\text{CF}_3)\text{I}$ was initially examined in the context of the in situ Cu-catalyzed trifluoromethylation of aryl iodide **1** under various conditions. The results of the reaction are summarized in Table 1. After $\text{Zn}(\text{CF}_3)\text{I}$ was prepared in situ by the treatment of CF_3I (ca. 5 equiv) with Zn dust (2 equiv) [22] in various solvents at room temperature for 2 hours, the reactions were explored by adding a catalytic amount of copper(I) salt and 1,10-phenanthroline (phen) [18–21] followed by aryl iodide **1a**. In this catalytic

Table 1: Copper-catalyzed trifluoromethylation of aryl iodide **1a**.

entry	solvent	Cu cat.	(X, Y)	T	% yield (2a/3a) ^a
1	toluene	CuI	10, 20	50	n.r.
2	THF	CuI	10, 20	50	n.r.
3	CH_3CN	CuI	10, 20	50	1/1
4	DMSO	CuI	10, 20	50	2/0
5	NMP	CuI	10, 20	50	n.r.
6	DMF	CuI	10, 20	50	44/8
7	DMPU	CuI	10, 20	50	70/9
8	DMPU	CuI	10, 10	50	93/7
9	DMPU	CuI	10, 10	rt	61/2
10	DMPU	CuI	10, 10	40	67/5
11	DMPU	CuI	10, 10	65	77/10
12	DMPU	CuCl	10, 10	50	92/8
13	DMPU	CuTC	10, 10	50	92/6
14	DMPU	CuI	2, 2	50	95/2

^aYields were determined by ^{19}F NMR analysis by using benzotrifluoride as an internal standard.

system, solvents showed significant effects on the preparation and catalytic reactivity of $\text{Zn}(\text{CF}_3)\text{I}$. No reaction was observed in less polar solvents such as toluene (Table 1, entry 1). Even in THF, CH_3CN , DMSO, and NMP, the desired product **2a** was barely or not at all obtained (Table 1, entries 2–5). Formation of $\text{Zn}(\text{CF}_3)\text{I}$ and reaction in DMF were found to proceed only with 44% yield (Table 1, entry 6). Replacement of DMF with DMPU provided the trifluoromethylated product **2a** in 70% yield, along with the undesired pentafluoroethylated product **3a** in 9% yield (Table 1, entry 7).

The product **3a** should be derived from CuCF_2CF_3 generated by an insertion of difluoromethylene ($:\text{CF}_2$) decomposed from CuCF_3 into CuCF_3 [23]. Decreasing the loading of phen, the yield of product **2a** was further increased to exceed the level of 90% yield (Table 1, entry 8). The reaction was promoted even under the milder reaction conditions at room temperature (61% yield), but the highest yield was obtained at 50 °C (Table 1, entry 8 vs entries 9–11). A further change from CuI to CuCl and CuTC led to comparable results (Table 1, entries 12 and 13). With only a 2 mol % loading of both CuI and phen ligand, the yield of **2a** was further increased to a higher level (95% yield) along with an increased selectivity with only 2% yield of **3a** (Table 1, entry 14).

The ligand effect was further investigated in DMPU at 50 °C and phen was preferable to other diamine ligands (Table 2, entries 1–3 vs entry 4). Surprisingly, even in the absence of phen, it was found that the reaction smoothly proceeded to give a comparably high yield of product **2a** (Table 2, entry 6). The reaction with a shorter reaction time of 2 hours indicated that the phen ligand slightly accelerated the reaction by the coordination to CuCF_3 species, when compared to the reactions performed without the ligand (Table 2, entry 5 (78% yield) vs entry 6 (68% yield)). In the absence of CuI , no coupling product was obtained even in the presence of phen (Table 2, entries 7 and 8).

With the reaction conditions established in DMPU at 50 °C in the presence of a catalytic amount of CuI and phen, the scope and limitation of this method were evaluated. The results are shown in Figure 1. The use of the electron-deficient aryl iodides **1b–f** bearing nitrile, nitro, formyl, and trifluoromethyl groups led to the corresponding products **2b–f** in moderate to high yields. The reactions of heteroaryl iodides **1g–i** were also catalyzed to provide the corresponding products **2g–i** in good to excellent yields. In the case of **1h**, the formation of a CF_3 group occurred only at the position of iodide, and bromide remained intact during the course of reaction. It was found that an

Table 2: Effect of ligands in copper-catalyzed trifluoromethylation.

entry	ligand	(X, Y)	% yield (2a/3a) ^a
1	TMEDA	10, 10	89/3
2	DMEDA	10, 10	83/3
3	bipy	10, 10	86/9
4	phen	10, 10	93/7
5	phen	2, 2	95/2 (78/1) ^b
6	–	2, 0	97/3 (68/1) ^b
7	–	0, 0	n.r.
8	phen	0, 2	n.r.

^aYields were determined by ^{19}F NMR analysis by using benzotrifluoride as an internal standard. ^bValues in parentheses are yields obtained with a reaction time of 2 hours.

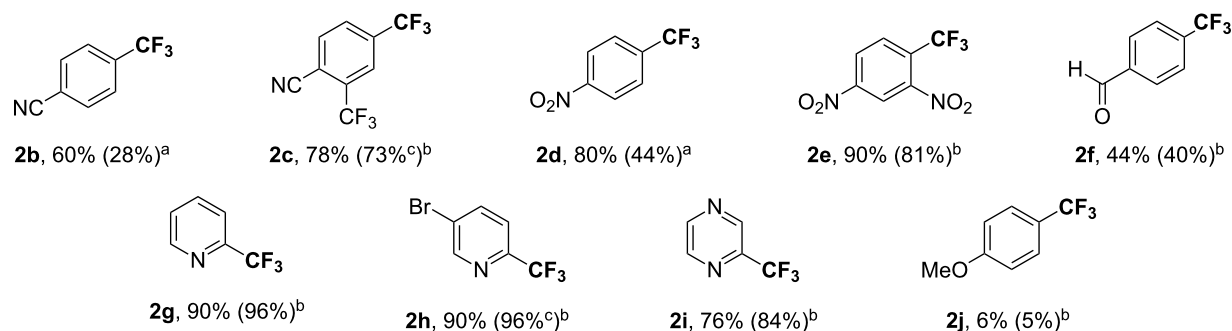
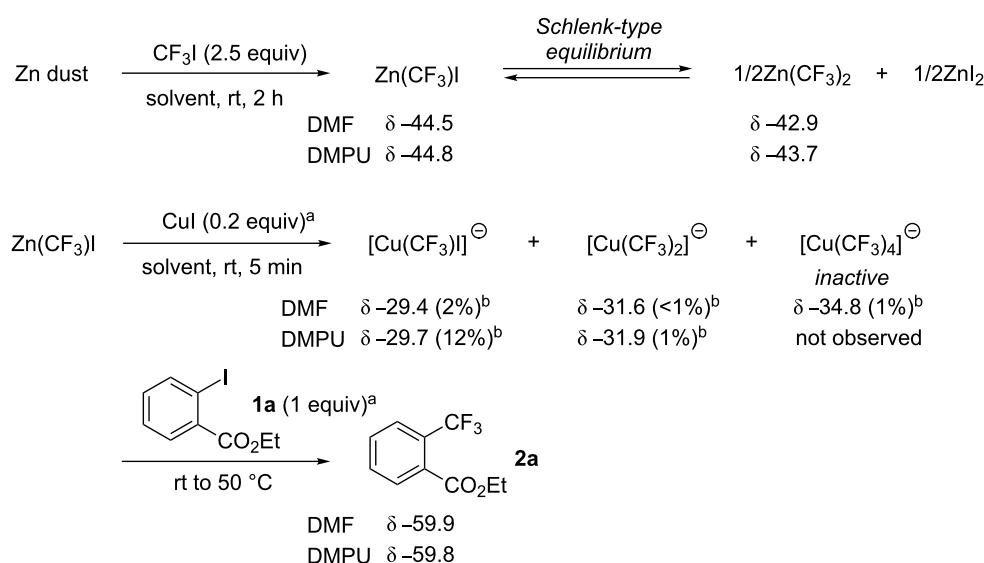

Figure 1: Copper-catalyzed trifluoromethylation of various aryl iodides. Yields were determined by ^{19}F NMR analysis by using benzotrifluoride as an internal standard. Values in parentheses are yields obtained under the reaction conditions without phen. Conditions: CF_3I ($2.5 \times X$ equiv) and Zn dust (X equiv) in DMPU, then CuI (Y mol %), phen (Y mol %) and **1** (1 equiv) at 50°C for t hours. ^a $X = 4$, $Y = 2$, $t = 48$. ^b $X = 2$, $Y = 10$, $t = 24$. ^cIsolated yields: **2c**, 70%; **2h**, 90%.

increase of the yield in the presence of the phen ligand depends on the particular substrate, while the yields were within the same range except for **2b** and **2d**. Unfortunately, aryl iodide **1j** bearing the electron-donating methoxy substituent extremely decreased the reactivity, even when increasing the catalytic amounts of CuI and phen.

In order to gain an insight into each step of the catalytic trifluoromethylation with a trifluoromethylzinc reagent, a ^{19}F NMR analysis in DMF and DMPU was performed (Scheme 1). At the initial stage, $\text{Zn}(\text{CF}_3)\text{I}$ which readily causes a Schlenk equilibrium with $\text{Zn}(\text{CF}_3)_2$ and ZnI_2 [14,24] was prepared in situ from CF_3I and Zn dust in 60–80% yields in both solvents. The addition of CuI (0.2 equiv) to a DMPU solution of $\text{Zn}(\text{CF}_3)\text{I}$ led to the transmetalation of the CF_3 group

from zinc to copper even at room temperature. Two singlet peaks of the cuprate species, $[\text{Cu}(\text{CF}_3)\text{I}]^-$ (-29.7 ppm) and $[\text{Cu}(\text{CF}_3)_2]^-$ (-31.9 ppm) were observed in 12% and 1% yields, respectively [23,25,26]. By replacing DMPU with DMF as a solvent, the transmetalation was found to be less efficient than in DMPU. Moreover, the inactive copper species $[\text{Cu}(\text{CF}_3)_4]^-$ (-34.8 ppm) [27] was obtained. The neutral CuCF_3 species (-26.3 ppm), which formed by the direct cupration of fluorofrom in DMF [28] and was active even with aryl iodides bearing electron-donating substituents such as **1j** [28-30], was not observed in both solvents. Thus, the addition of aryl iodide **1a** led to the formation of the trifluoromethyl coupling product **2a** (-59.8 ppm) even in the absence of phen, involving the consumption of the cuprates $[\text{Cu}(\text{CF}_3)\text{I}]^-$ and $[\text{Cu}(\text{CF}_3)_2]^-$. The use of DMF as a solvent led to a gradual increase of the



Scheme 1: Observation of CuCF_3 species in ^{19}F NMR spectrum. ^aEquivalentents based on $\text{Zn}(\text{CF}_3)\text{I}$. ^bYields based on CuI.

peak assigned as inactive $[\text{Cu}(\text{CF}_3)_4]^-$ during the course of the reaction.

The mechanism of the coupling reaction can thus be visualized by the following catalytic cycle (Scheme 2). At the first step, the transmetalation of the CF_3 group to CuI from $\text{Zn}(\text{CF}_3)\text{I}$ or $\text{Zn}(\text{CF}_3)_2$ affords the active cuprate species, $[\text{Cu}(\text{CF}_3)\text{X}]^-$ ($\text{X} = \text{I}, \text{CF}_3$). Subsequently, the oxidative addition to the cuprate of aryl iodide **1**, and the reductive elimination gives the desired cross-coupling product **2** together with the formation of ZnI_2 .

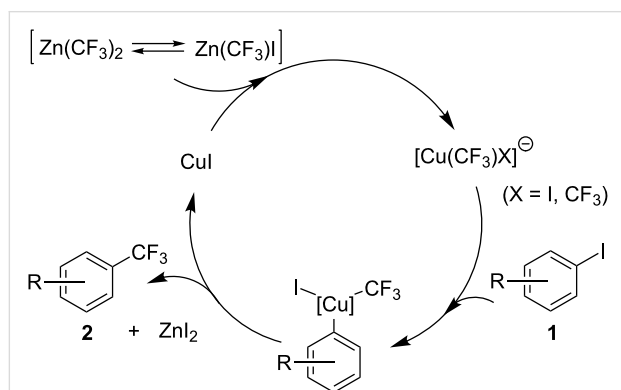

Scheme 2: Proposed mechanism of copper-catalyzed trifluoromethylation.

Conclusion

In summary, we succeeded in the aromatic trifluoromethylation catalyzed by copper(I) salt with a trifluoromethylzinc reagent prepared in situ from trifluoromethyl iodide and Zn dust in DMPU. The catalytic reaction proceeded to provide moderate to high yields and a high selectivity of the trifluoromethylated product under mild reaction conditions. The advantage of this catalytic reaction is that additives such as metal fluoride (MF), which are indispensable to activate silyl substituents for the transmetalation in the corresponding catalytic reactions by using the Ruppert–Prakash reagents, are not necessary. Additionally, with some substrates, the reaction conditions without a ligand led to higher yields than reaction conditions with a ligand such as 1,10-phenanthroline. Further studies on highly efficient trifluoromethylation and difluoromethylation reactions with trifluoromethylzinc reagents are under way.

Experimental

Typical procedure for copper-catalyzed trifluoromethylation of aryl iodide

To the suspension of zinc powder (without activation, 65.4 mg, 1.0 mmol, Aldrich 99.995% purity) in DMPU (0.5 mL), trifluoromethyl iodide (ca. 2.5 mmol, sufficiently dissolved in the solution) was added at room temperature under argon atmosphere. After the solution was stirred for 2 h at room tempera-

ture, CuI (1.9 mg, 0.01 mmol, 2 mol %), 1,10-phenanthroline (1.8 mg, 0.01 mmol, 2 mol %), and then aryl iodide **1a** (138.0 mg, 0.5 mmol) were added. The reaction mixture was stirred at 50 °C for 24 h. After cooling to room temperature, the yield of product **2a** was determined by ^{19}F NMR analysis by using benzotrifluoride (BTF) as an internal standard. Except for **2c**, all trifluoromethylated products **2** exhibited the same ^1H , ^{13}C , and ^{19}F NMR spectra as reported before [14,17,29,31–36].

2,4-Bis(trifluoromethyl)benzotrile (**2c**)

To the suspension of zinc powder (without activation, 65.4 mg, 1.0 mmol, Aldrich 99.995% purity) in DMPU (0.5 mL), trifluoromethyl iodide (ca. 2.5 mmol, sufficiently dissolved in the solution) was added at room temperature under argon atmosphere. The solution was stirred for 2 h, and CuI (9.5 mg, 0.05 mmol, 10 mol %) and 4-iodo-2-(trifluoromethyl)benzotrile (**1c**, 148.5 mg, 0.5 mmol) were added. The reaction mixture was stirred at 50 °C for 24 h. The reaction mixture was quenched with H_2O (5 mL), and then Et_2O (5 mL) was added. After filtration over celite, the organic layer was separated, and the aqueous layer was extracted with Et_2O (5 mL \times 3). The combined organic layer was washed with brine (10 mL), dried over Na_2SO_4 , and evaporated. The resulting crude product was purified by silica gel column chromatography (pentane/ Et_2O 9:1) to give the product **2c** (83 mg, 70% yield) as a colorless liquid. ^1H NMR (300 MHz, CDCl_3) δ 8.06 (s, 1H), 8.03 (d, $J = 8.2$ Hz, 1H), 7.98 (d, $J = 8.2$ Hz, 1H); ^{13}C NMR (400 MHz, CDCl_3) δ 135.5, 135.0 (q, $J_{\text{CF}} = 34.4$ Hz), 134.0 (q, $J_{\text{CF}} = 33.5$ Hz), 129.3 (q, $J_{\text{CF}} = 3.6$ Hz), 124.1–123.9 (m), 122.3 (q, $J_{\text{CF}} = 271.9$ Hz), 121.6 (q, $J_{\text{CF}} = 272.7$ Hz), 114.1, 113.9; ^{19}F NMR (282 MHz, CDCl_3) δ -62.2 (s, 3F), -63.6 (s, 3F); HRMS–ESITOF (m/z): $[\text{M} - \text{H}]^-$ calcd for $\text{C}_9\text{H}_2\text{F}_6\text{N}$, 238.0091; found, 238.0086; FTIR (neat, cm^{-1}) 2238, 1344, 1146, 1279, 1082.

Observation of trifluoromethylcopper species in ^{19}F NMR spectrum

To the suspension of zinc powder (without activation, 32.7 mg, 0.5 mmol, Aldrich 99.995% purity) in DMF or DMPU (0.75 mL), trifluoromethyl iodide (ca. 1.25 mmol, 2.5 equiv, sufficiently dissolved to the solution) was added at room temperature under argon atmosphere. After the solution was stirred for 2 h at room temperature, the remaining trifluoromethyl iodide was removed by bubbling argon through the solution for 15 min. To the solution was added CuI (19.0 mg, 0.1 mmol) at room temperature. After the reaction mixture was stirred for 5 min, the generation of cuprate species was monitored by ^{19}F NMR analysis by using benzotrifluoride (10 μL , 0.0814 mmol) as an internal standard and sealed capillary filled with benzene- d_6 for signal lock under argon atmosphere at room temperature.

Acknowledgements

This research was partly supported by a grant program “Creation of Advanced Catalytic Transformation for the Sustainable Manufacturing at Low Energy, Low Environmental Load (ACT-C)” from the Japan Science and Technology Agency (JST). We thank TOSOH F-TECH, INC. for donating the trifluoromethyl iodide.

References

- Kirsch, P. *Modern Fluoroorganic Chemistry: Synthesis, Reactivity, Applications*, 2nd ed.; Wiley-VCH: Weinheim, Germany, 2013. doi:10.1002/9783527651351
- Uneyama, K. *Organofluorine Chemistry*; Blackwell: Oxford, U.K., 2006. doi:10.1002/9780470988589
- Hiyama, T. *Organofluorine Compounds: Chemistry and Applications*; Springer-Verlag: Berlin, 2000. doi:10.1007/978-3-662-04164-2
- Ojima, I. *Fluorine in Medicinal Chemistry and Chemical Biology*; Wiley-Blackwell: Chichester, U.K., 2009.
- Furuya, T.; Kamlet, A. S.; Ritter, T. *Nature* **2011**, *473*, 470–477. doi:10.1038/nature10108
- Jin, Z.; Hammond, G. B.; Xu, B. *Aldrichimica Acta* **2012**, *45*, 67–83.
- Tomashenko, O. A.; Grushin, V. V. *Chem. Rev.* **2011**, *111*, 4475–4521. doi:10.1021/cr1004293
- Nie, J.; Guo, H.-C.; Cahard, D.; Ma, J.-A. *Chem. Rev.* **2011**, *111*, 455–529. doi:10.1021/cr100166a
- Mikami, K.; Itoh, Y.; Yamanaka, M. *Chem. Rev.* **2004**, *104*, 1–16. doi:10.1021/cr030685w
- Burton, D. J.; Yang, Z.-Y. *Tetrahedron* **1992**, *48*, 189–275. doi:10.1016/S0040-4020(01)88139-4
- Prakash, G. K. S.; Yudin, A. K. *Chem. Rev.* **1997**, *97*, 757–786. doi:10.1021/cr9408991
- Prakash, G. K. S.; Mandal, M. *J. Fluorine Chem.* **2001**, *112*, 123–131. doi:10.1016/S0022-1139(01)00477-8
- Naumann, D.; Tyrra, W.; Kock, B.; Rudolph, W.; Wilkes, B. *J. Fluorine Chem.* **1994**, *67*, 91–93. doi:10.1016/0022-1139(93)02937-A
- Kremlev, M. M.; Tyrra, W.; Mushta, A. I.; Naumann, D.; Yagupolskii, Y. L. *J. Fluorine Chem.* **2010**, *131*, 212–216. doi:10.1016/j.jfluchem.2009.10.011
- Prakash, G. K. S.; Jog, P. V.; Batamack, P. T. D.; Olah, G. A. *Science* **2012**, *338*, 1324–1327. doi:10.1126/science.1227859
- Kitazume, T.; Ishikawa, N. *J. Am. Chem. Soc.* **1985**, *107*, 5186–5191. doi:10.1021/ja00304a026
- Popov, I.; Lindeman, S.; Daugulis, O. *J. Am. Chem. Soc.* **2011**, *133*, 9286–9289. doi:10.1021/ja2041942
- Oishi, M.; Kondo, H.; Amii, H. *Chem. Commun.* **2009**, 1909–1911. doi:10.1039/b823249k
- Cho, E. J.; Senecal, T. D.; Kinzel, T.; Zhang, Y.; Watson, D. A.; Buchwald, S. L. *Science* **2010**, *328*, 1679–1681. doi:10.1126/science.1190524
- Chu, L.; Qing, F.-L. *J. Am. Chem. Soc.* **2012**, *134*, 1298–1304. doi:10.1021/ja209992w
- Jiang, X.; Chu, L.; Qing, F.-L. *J. Org. Chem.* **2012**, *77*, 1251–1257. doi:10.1021/jo202566h
- Aldrich: Lot# MKBK3648V, powder <150 µm, 99.995% trace metals basis.
- Wiemers, D. M.; Burton, D. J. *J. Am. Chem. Soc.* **1986**, *108*, 832–834. doi:10.1021/ja00264a043
- Francèse, C.; Tordeux, M.; Wakselman, C. *Tetrahedron Lett.* **1988**, *29*, 1029–1030. doi:10.1016/0040-4039(88)85326-7
- Hu, M.; Ni, C.; Hu, J. *J. Am. Chem. Soc.* **2012**, *134*, 15257–15260. doi:10.1021/ja307058c
- Kütt, A.; Movchun, V.; Rodima, T.; Dansauer, T.; Rusanov, E. B.; Leito, I.; Kaljurand, I.; Koppel, J.; Pihl, V.; Koppel, I.; Ovsjannikov, G.; Toom, L.; Mishima, M.; Medebielle, M.; Lork, E.; Rösenthaler, G.-V.; Koppel, I. A.; Kolomeitsev, A. A. *J. Org. Chem.* **2008**, *73*, 2607–2620. doi:10.1021/jo702513w
- Naumann, D.; Roy, T.; Tebbe, K.-F.; Crump, W. *Angew. Chem., Int. Ed. Engl.* **1993**, *32*, 1482–1483. doi:10.1002/anie.199314821
- Zanardi, A.; Novikov, M. A.; Martin, E.; Benet-Buchholz, J.; Grushin, V. V. *J. Am. Chem. Soc.* **2011**, *133*, 20901–20913. doi:10.1021/ja2081026
- Morimoto, H.; Tsubogo, T.; Litvinas, N. D.; Hartwig, J. F. *Angew. Chem., Int. Ed.* **2011**, *50*, 3793–3798. doi:10.1002/anie.201100633
- Serizawa, H.; Aikawa, K.; Mikami, K. *Chem.–Eur. J.*, in press.
- Anbarasan, P.; Neumann, H.; Beller, M. *Chem.–Eur. J.* **2011**, *17*, 4217–4222. doi:10.1002/chem.201003388
- Kondratenko, N. V.; Vechirko, E. P.; Yagupolskii, L. M. *Synthesis* **1980**, 932–933. doi:10.1055/s-1980-29276
- Kremlev, M. M.; Mushta, A. I.; Tyrra, W.; Yagupolskii, Y. L.; Naumann, D.; Möller, A. *J. Fluorine Chem.* **2012**, *133*, 67–71. doi:10.1016/j.jfluchem.2011.07.025
- Ye, Y.; Sanford, M. S. *J. Am. Chem. Soc.* **2012**, *134*, 9034–9037. doi:10.1021/ja301553c
- Knauber, T.; Arian, F.; Rösenthaler, G.-V.; Gooßen, L. J. *Chem.–Eur. J.* **2011**, *17*, 2689–2697. doi:10.1002/chem.201002749
- Lumma, W. C., Jr.; Hartman, R. D.; Saari, W. S.; Engelhardt, E. L.; Hirschmann, R.; Clineschmidt, B. V.; Torchiana, M. L.; Stone, C. A. *J. Med. Chem.* **1978**, *21*, 536–542. doi:10.1021/jm00204a007

License and Terms

This is an Open Access article under the terms of the Creative Commons Attribution License (<http://creativecommons.org/licenses/by/2.0>), which permits unrestricted use, distribution, and reproduction in any medium, provided the original work is properly cited.

The license is subject to the *Beilstein Journal of Organic Chemistry* terms and conditions: (<http://www.beilstein-journals.org/bjoc>)

The definitive version of this article is the electronic one which can be found at: [doi:10.3762/bjoc.9.277](https://doi.org/10.3762/bjoc.9.277)

Oxidative 3,3,3-trifluoropropylation of arylaldehydes

Akari Ikeda, Masaaki Omote, Shiho Nomura, Miyuu Tanaka, Atsushi Tarui,
Kazuyuki Sato and Akira Ando*

Full Research Paper

Open Access

Address:
Faculty of Pharmaceutical Sciences, Setsunan University, 45-1,
Nagaotoge-cho, Hirakata, Osaka 573-0101, Japan

Email:
Akira Ando* - aando@pharm.setsunan.ac.jp

* Corresponding author

Keywords:
cesium fluoride; organo-fluorine; 1,3-proton shift; trifluoromethyl;
3,3,3-trifluoropropenyl

Beilstein J. Org. Chem. 2013, 9, 2417–2421.
doi:10.3762/bjoc.9.279

Received: 27 August 2013
Accepted: 10 October 2013
Published: 11 November 2013

This article is part of the Thematic Series "Organo-fluorine chemistry III".

Guest Editor: D. O'Hagan

© 2013 Ikeda et al; licensee Beilstein-Institut.
License and terms: see end of document.

Abstract

A reaction between (*E*)-trimethyl(3,3,3-trifluoroprop-1-en-1-yl)silane (**1**) and arylaldehydes **2** was triggered by fluoride anions to afford aryl 3,3,3-trifluoropropyl ketones **3** in moderate to good yield. A mechanistic study of this reaction indicated that it occurred via an allyl alkoxide (**4**). A subsequent 1,3-proton shift of the benzylic proton of **4** forms **3**. This reaction involves oxidative 3,3,3-trifluoropropylation of an arylaldehyde to afford 4,4,4-trifluoro-1-arylbutan-1-one.

Introduction

Trifluoromethyl groups are an essential motif in pharmaceuticals, agricultural chemicals, and functional materials because trifluoromethylation of such chemicals often significantly improves their performance [1-6]. To date, the trifluoromethylation of carbonyl compounds [7-10] and aryl halides [11-13] has been extensively explored. On the other hand, the 2,2,2-trifluoroethylation and the 3,3,3-trifluoropropylation, which elongate the product by two and three carbon atoms, respectively, have not been explored yet. 2-Bromo-3,3,3-trifluoropropene [14-26] and 1,1,1,3,3-pentafluoropropane [27,28] have been used in place of (3,3,3-trifluoropropynyl)lithium, which can add to carbonyl compounds and couple with aryl halides through a zinc intermediate. For the 3,3,3-trifluoropropenyl synthon Yamazaki et al. reported the use of 2-(trifluoromethyl)-1-(phenyl-

sulfenyl)vinyltrimethylsilane for the addition to aldehydes in the presence of fluoride anion [29]. Recently, Prakash et al. [30] reported the synthesis of β -trifluoromethylstyrenes through a Heck coupling reaction of aryl iodides with 1-iodo-3,3,3-trifluoropropane, allowing a direct introduction of 3,3,3-trifluoropropenyl groups to aromatic rings. Approximately at the same time, our research group demonstrated that (*E*)-trimethyl(3,3,3-trifluoroprop-1-en-1-yl)silane (**1**) effectively participated in a Hiyama cross-coupling reaction with aryl iodide to construct β -trifluoromethylstyrenes in good to excellent yield [31,32]. In the course of this study, we found that the reaction of **1** with benzaldehyde in the presence of fluoride anions afforded an allyl alcohol, which spontaneously isomerized to phenyl 3,3,3-trifluoropropyl ketone (**3a**). This reaction involves a one-pot

synthesis of aryl 3,3,3-trifluoropropyl ketones from the corresponding arylaldehyde, representing the oxidative 3,3,3-propenylation of the arylaldehyde. Here, we report our study of this unusual reaction.

Results and Discussion

At the outset of our study, we attempted selective C–Si bond dissociation of **1** with several fluoride anion sources. The subsequently generated carbanion was trapped with benzaldehyde to generate 4,4,4-trifluoromethylallyl alcohol **4** (Table 1). We found that this reaction did not take place when either TiF₄ in THF or CuF₂/dppp in DMF was used (Table 1, entries 1 and 2). However, the reaction proceeded when two equivalents of CsF to arylaldehyde **2** were used in DMA at a temperature of 55 °C, affording **3a** and **4a** in 15% and 16% yield, respectively (Table 1, entry 3). In contrast, the reaction did not proceed in THF (Table 1, entry 4). The yield increased as the temperature was raised to 80 °C, but a further increase to 100 °C did not improve the yield of the reaction (Table 1, entries 5 and 6). Changing the solvent to DMF considerably shortened the reaction time. The added amount of CsF also influenced this reaction. The reaction conducted with four equivalents of CsF afforded **3a** and **4a** in 52% and 27% yield, respectively (Table 1, entry 8). However, a further increase of the amount of CsF did not improve the reaction yield (Table 1, entry 9). We thus determined that the conditions used in entry 8 of Table 1 were optimal. We explored the scope and limitation of this reaction by using these optimal conditions.

A variety of arylaldehydes participated in the reaction to give products in moderate to good yields (Table 2). The reactions with benzaldehyde derivatives with an electron-withdrawing group, such as chloro-, bromo-, fluoro- or trifluoromethyl, at the *para*-position proceeded to give **3b–e** in moderate to good yields (Table 2, entries 1 to 4). The substitution with other electron-withdrawing groups such as methoxycarbonyl and cyano decreased the yield of the product, **3f** and **3g** were obtained in 38% and 46% yield, respectively (Table 2, entries 5 and 6). In contrast, the substitution of benzaldehyde with an electron-donating group slowed down the reaction substantially. *p*-Methyl and *p*-methoxybenzaldehydes gave **3h** and **3i** in 26% and 17% yield, respectively (Table 2, entries 7 and 8). *meta*-Substitution of benzaldehyde with a methoxy group gave **3j** in 58% yield (Table 2, entry 9). These results are in accordance with the Hammett equation. *ortho*-Substitution of substrates decreased the yield of the products substantially, probably because of the steric hindrance introduced by the substituent (Table 2, entries 10 and 11). While the reaction could be applied to polycyclic and heterocyclic compounds, **3m** and **3n** were only obtained in low yield (Table 2, entries 12 and 13). An aliphatic aldehyde did not participate in the reaction (Table 2, entry 14).

During the course of this study, it became obvious that the reaction gave allyl alcohol **4** first, and then subsequent transformation of **4** into **3** occurred during the reaction process. Recently, both Cahard et al. [33,34] and Qing et al. [35] independently

Table 1: Reaction of **1** with benzaldehyde in the presence of fluoride anions.^a

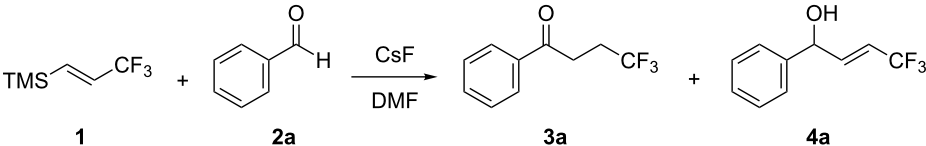

entry	F anion (equiv) ^b	1 (equiv) ^b	solvent	temp (°C)	time (h)	yield (%) ^{c,d}	
						3a	4a
1	TiF ₄ (2)	2	THF	60	24	–	–
2	CuF ₂ (1)/dppp (2)	2	DMF	80	26	–	–
3	CsF (2)	1.5	DMA	55	24	15	16
4	CsF (2)	1.5	THF	55	24	–	–
5	CsF (2)	2	DMA	80	4	53	–
6	CsF (2)	2	DMA	100	4	47	–
7	CsF (2)	2	DMF	80	1	49	10
8	CsF (4)	2	DMF	80	1	52 (43)	27
9	CsF (6)	2	DMF	80	1	38	5

^aThe reaction was carried out with **2a** (0.2 mmol) and a solvent (2.0 mL). ^bThe value in parentheses indicates equiv with respect to benzaldehyde (0.2 mmol). ^cNMR yields, which were calculated by integration of the ¹⁹F NMR signals of **3a** and **4a** relative to that of the internal standard of 1,4-bis(trifluoromethyl)benzene. ^dThe value in parentheses indicates isolated yield (%).

Table 2: Investigation of reaction scope with optimal conditions.^a

entry	Ar-CHO	3	yield (%) ^b	4	yield (%) ^b
1	<i>p</i> -Cl-C ₆ H ₄	3b	72	4b	8
2	<i>p</i> -Br-C ₆ H ₄	3c	79	4c	6
3	<i>p</i> -F-C ₆ H ₄	3d	55	4d	4
4	<i>p</i> -CF ₃ -C ₆ H ₄	3e	59	4e	6
5	<i>p</i> -CH ₃ OC(O)-C ₆ H ₄	3f	38	4f	6
6	<i>p</i> -CN-C ₆ H ₄	3g	46	4g	10
7	<i>p</i> -CH ₃ -C ₆ H ₄	3h	26	4h	8
8	<i>p</i> -CH ₃ O-C ₆ H ₄	3i	17	4i	16
9	<i>m</i> -CH ₃ O-C ₆ H ₄	3j	58	4j	10
10	<i>o</i> -CH ₃ O-C ₆ H ₄	3k	12	4k	35
11	<i>o</i> -Cl-C ₆ H ₄	3l	16	4l	16
12	2-naphthyl	3m	41	4m	5
13	3-pyridyl	3n	31	4n	12
14	C ₆ H ₅ (CH ₂) ₂	3o	–	3o	–

^aReactions were carried out with **1** (0.4 mmol), **2** (0.2 mmol) and CsF (0.8 mmol) in DMF (2.0 mL) at 80 °C. ^bNMR yields, which were calculated by integration of the ¹⁹F NMR signals **3** and **4** relative to that of the internal standard of 1,4-bis(trifluoromethyl)benzene.

reported that the isomerization of a 4,4,4-trifluoromethylallyl alcohol substructure was promoted by a ruthenium catalyst to form a 3,3,3-trifluoropropylcarbonyl unit. We hypothesized that the formation of **3** would be promoted by inter- or intramolecular migration of the benzylic proton of **4** in the basic medium. To confirm the hypothesis, we conducted the reaction by using benzaldehyde-*d* to clarify whether or not proton migration was involved in the reaction sequence. When benzaldehyde-*d* was treated with **1** and CsF in DMF at 80 °C, the reaction gave a product in which deuterium was inserted on the α - and β -carbons of the carbonyl group with rates of 22% and 53%, respectively (Scheme 1, (1)). This result suggests that deuterium on the β -carbon should be incorporated by a 1,3-proton shift. In contrast, deuterium on the α -carbon should be inserted when the enolate intermediate, which is generated during the reaction, intermolecularly extracted the benzylic deuterium of **4**. To

further investigate the reaction mechanism, **4a** was exposed to basic conditions to observe whether or not the isomerization of **4a** to **3a** would occur. Indeed, the treatment of **4a** with a stoichiometric amount of DBU resulted in an almost quantitative conversion to **3a** (Scheme 1, (2)).

This suggests that the reaction provides **4** first. **4** subsequently isomerizes to form **3**, which is an oxidative 3,3,3-trifluoropropylation of the arylaldehyde. These results allowed us to propose the reaction mechanism shown in Scheme 2, which includes the isomerization of **5** to **6** in the formation of **3**. To support our proposed mechanism, a computational calculation was performed with Gaussian 03W at the B3LYP/6-31+G* level of theory to confirm that key intermediate **7** was involved in the isomerization process. The calculation indicated that intermediate **5** generated in the first step of the reaction was

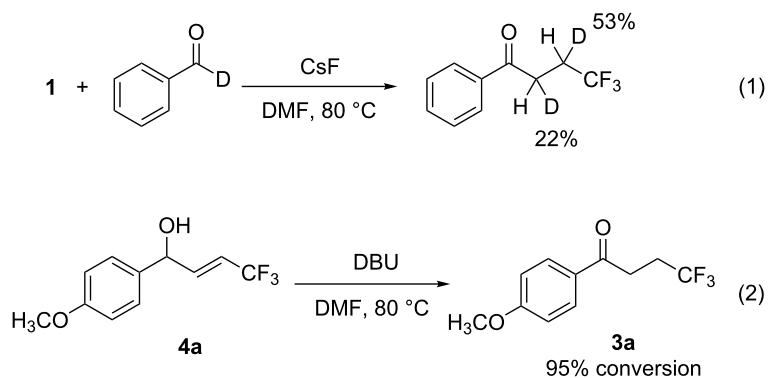
**Scheme 1:** Experiments to elucidate the reaction mechanism.

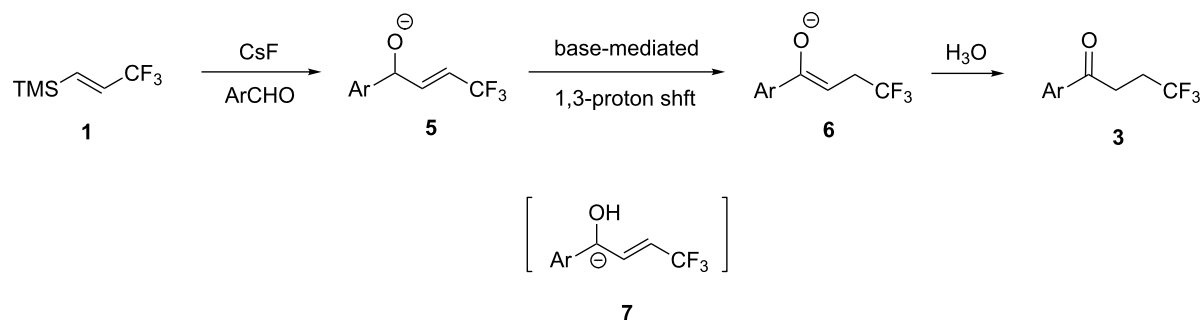

Scheme 2: The proposed reaction mechanism.

slightly more stable (0.417 kcal/mol) than **7**. The slight energy difference between **5** and **7** indicates the viability of **7** in the reaction medium. The generation of **7** would facilitate the isomerization of **5** to **6**.

Conclusion

We reacted **1** with benzaldehyde in the presence of CsF to provide **3**. We demonstrated that **4** was generated in the first step of the reaction, and then subsequently isomerized to **3** under basic conditions. This sequential reaction involves an oxidative 3,3,3-trifluoropropylation of the arylaldehyde to form a 3,3,3-trifluoropropylcarbonyl unit. A further refinement of the reaction conditions to enhance the compatibility of the reaction with substrates such as aliphatic aldehydes is in progress in our group.

Supporting Information

Supporting Information File 1

Experimental details and characterization data for all new compounds.

[<http://www.beilstein-journals.org/bjoc/content/supplementary/1860-5397-9-279-S1.pdf>]

Acknowledgements

We thank Professor Takashi Yamazaki from the Graduate School of Engineering, Tokyo University of Agriculture and Technology for calculating the molecular stability of **5** and **7**.

References

- Tomaschenko, O. A.; Grushin, V. V. *Chem. Rev.* **2011**, *111*, 4475–4521. doi:10.1021/cr1004293
- Yamazaki, T.; Taguchi, T.; Ojima, I. Unique Properties of Fluorine and Their Relevance to Medicinal Chemistry and Chemical Biology. In *Fluorine in Medicinal Chemistry and Chemical Biology*; Ojima, I., Ed.; Wiley-Blackwell: Chichester, U.K., 2009; pp 3–46.
- Purser, S.; Moore, P. R.; Swallow, S.; Gouverneur, V. *Chem. Soc. Rev.* **2008**, *37*, 320–330. doi:10.1039/b610213c
- Müller, K.; Faeh, C.; Diederich, F. *Science* **2007**, *317*, 1881–1886. doi:10.1126/science.1131943
- Kirsch, P. *Modern Fluoroorganic Chemistry: Synthesis, Reactivity, Applications*; Wiley-VCH: Weinheim, Germany, 2004. doi:10.1002/352760393X
- Hiyama, T. In *Organofluorine Chemistry, Principles, and Commercial Applications*; Banks, R. E.; Smart, B. E.; Tatlow, C. J., Eds.; Springer: New York, 1994; pp 237–262.
- Prakash, G. K. S.; Yudin, A. K. *Chem. Rev.* **1997**, *97*, 757–786. doi:10.1021/cr9408991
- Prakash, G. K. S.; Krishnamurti, R.; Olah, G. A. *J. Am. Chem. Soc.* **1989**, *111*, 393–395. doi:10.1021/ja00183a073
- Shibata, N.; Mizuta, S.; Kawai, H. *Tetrahedron: Asymmetry* **2008**, *19*, 2633–2644. doi:10.1016/j.tetasy.2008.11.011
- Ma, J.-A.; Cahard, D. *J. Fluorine Chem.* **2007**, *128*, 975–996. doi:10.1016/j.jfluchem.2007.04.026
- Kobayashi, Y.; Kumadaki, I. *Tetrahedron Lett.* **1969**, *10*, 4095–4096. doi:10.1016/S0040-4039(01)88624-X
- Oishi, M.; Kondo, H.; Amii, H. *Chem. Commun.* **2009**, 1909–1911. doi:10.1039/b823249k
- Cho, E. J.; Senecal, T. D.; Kinzel, T.; Zhang, Y.; Watson, D. A.; Buchwald, S. L. *Science* **2010**, *328*, 1679–1681. doi:10.1126/science.1190524
- Mizutani, K.; Yamazaki, T.; Kitazume, T. *J. Chem. Soc., Chem. Commun.* **1995**, 51–52. doi:10.1039/C39950000051
- Yamazaki, T.; Mizutani, K.; Kitazume, T. *J. Org. Chem.* **1995**, *60*, 6046–6056. doi:10.1021/jo00124a013
- Konno, T.; Chae, J.; Kanda, M.; Nagai, G.; Tamura, K.; Ishihara, T.; Yamanaka, H. *Tetrahedron* **2003**, *59*, 7571–7580. doi:10.1016/S0040-4020(03)01199-2
- Chen, Q.; Qiu, X.-L.; Qing, F.-L. *J. Fluorine Chem.* **2007**, *128*, 1182–1186. doi:10.1016/j.jfluchem.2007.02.010
- Jiang, Z.-X.; Qin, Y.-Y.; Qing, F.-L. *J. Org. Chem.* **2003**, *68*, 7544–7547. doi:10.1021/jo0344384
- Xiong, Z.; Qiu, X.-L.; Huang, Y.; Qing, F.-L. *J. Fluorine Chem.* **2011**, *132*, 166–174. doi:10.1016/j.jfluchem.2010.12.012
- Hanamoto, T.; Hakoshima, Y.; Egashira, M. *Tetrahedron Lett.* **2004**, *45*, 7573–7576. doi:10.1016/j.tetlet.2004.08.118
- Chen, X.-Y.; Qiu, X.-L.; Qing, F.-L. *Tetrahedron* **2008**, *64*, 2301–2306. doi:10.1016/j.tet.2008.01.021
- Yamazaki, T.; Ichige, T.; Kitazume, T. *Org. Lett.* **2004**, *6*, 4073–4076. doi:10.1021/ol048229x
- Watanabe, Y.; Yamazaki, T. *J. Org. Chem.* **2011**, *76*, 1957–1960. doi:10.1021/jo102503s

24. Yamazaki, Y.; Yamamoto, T.; Ichihara, R. *J. Org. Chem.* **2006**, *71*, 6251–6253. doi:10.1021/jo060909l
25. Yamazaki, T.; Kawasaki-Takasuka, T.; Furuta, A.; Sakamoto, S. *Tetrahedron* **2009**, *65*, 5945–5948. doi:10.1016/j.tet.2009.05.087
26. Konno, T.; Moriyasu, K.; Ishihara, T. *Synthesis* **2009**, 1087–1094. doi:10.1055/s-0028-1087988
27. Brisdon, A. K.; Crossley, I. R.; Pritchard, R. G.; Sadiq, G.; Warren, J. E. *Organometallics* **2003**, *22*, 5534–5542. doi:10.1021/om034146t
28. Brisdon, A. K.; Crossley, I. R. *Chem. Commun.* **2002**, *20*, 2420–2421. doi:10.1039/b207979h
29. Yamazaki, T.; Takita, K.; Ishikawa, N. *J. Fluorine Chem.* **1985**, *30*, 357–363. doi:10.1016/S0022-1139(00)84971-4
30. Prakash, G. K. S.; Krishnan, H. S.; Jog, P. V.; Iyer, A. P.; Olah, G. A. *Org. Lett.* **2012**, *14*, 1146–1149. doi:10.1021/ol300076y
31. Omote, M.; Tanaka, M.; Ikeda, A.; Nomura, S.; Tarui, A.; Sato, K.; Ando, A. *Org. Lett.* **2012**, *14*, 2286–2289. doi:10.1021/ol300670n
32. Omote, M.; Tanaka, M.; Tanaka, M.; Ikeda, A.; Tarui, A.; Sato, K.; Ando, A. *J. Org. Chem.* **2013**, *78*, 6196–6201. doi:10.1021/jo400859s
33. Bizet, V.; Pannecoucke, X.; Renaud, J.-L.; Cahard, D. *Angew. Chem., Int. Ed.* **2012**, *51*, 6467–6470. doi:10.1002/anie.201200827
34. Bizet, V.; Pannecoucke, X.; Renaud, J.-L.; Cahard, D. *J. Fluorine Chem.* **2013**, *152*, 56–61. doi:10.1016/j.jfluchem.2013.01.004
35. Qing, F.; Gao, W. *Chin. J. Org. Chem.* **2000**, *20*, 764–768. http://sioc-journal.cn/Jwk_yjhx/EN/abstract/abstract333670.shtml

License and Terms

This is an Open Access article under the terms of the Creative Commons Attribution License (<http://creativecommons.org/licenses/by/2.0>), which permits unrestricted use, distribution, and reproduction in any medium, provided the original work is properly cited.

The license is subject to the *Beilstein Journal of Organic Chemistry* terms and conditions: (<http://www.beilstein-journals.org/bjoc>)

The definitive version of this article is the electronic one which can be found at:
[doi:10.3762/bjoc.9.279](https://doi.org/10.3762/bjoc.9.279)

Triol-promoted activation of C–F bonds: Amination of benzylic fluorides under highly concentrated conditions mediated by 1,1,1-tris(hydroxymethyl)propane

Pier Alexandre Champagne, Alexandre Saint-Martin, Mélina Drouin
and Jean-François Paquin*

Letter

Open Access

Address:
Canada Research Chair in Organic and Medicinal Chemistry, CCVC,
PROTEO, Département de chimie, Université Laval, 1045 avenue de
la Médecine, Québec, QC, Canada G1V 0A6

Email:
Jean-François Paquin* - jean-francois.paquin@chm.ulaval.ca

* Corresponding author

Keywords:
C–F bond activation; highly concentrated conditions; nucleophilic
substitution; hydrogen bond; organofluorine; triol

Beilstein J. Org. Chem. **2013**, *9*, 2451–2456.
doi:10.3762/bjoc.9.283

Received: 27 August 2013
Accepted: 17 October 2013
Published: 13 November 2013

This article is part of the Thematic Series "Organo-fluorine chemistry III".

Guest Editor: D. O'Hagan

© 2013 Champagne et al; licensee Beilstein-Institut.
License and terms: see end of document.

Abstract

Activation of the C–F bond of benzylic fluorides was achieved using 1,1,1-tris(hydroxymethyl)propane (**2**) as a hydrogen bond-donating agent. Investigations demonstrated that hydrogen bond-donating solvents are promoting the activation and hydrogen bond-accepting ones are hindering it. However, the reaction is best run under highly concentrated conditions, where solvents cannot interfere with the interaction between the organofluorine compound and the triol. Various benzylic fluorides react with secondary amines or anilines to form benzylic amines in good yields.

Introduction

The discovery of mild methods for the activation of C–F bonds is of high importance both from a fundamental point of view as well as for potential practical applications [1]. Specifically for aliphatic monofluorides, a number of transition metal-catalyzed methods [1–9] and transition-metal-free methodologies [1,10–12] have been developed. In continuation with our interest in the activation of C–F bonds [13–16], we have recently reported that it was possible to enable the use of fluoride as a leaving group in nucleophilic substitution reactions of activated alkyl fluorides through hydrogen bonding [17]. Particularly, water

was used as the hydrogen bond donor and co-solvent. DFT calculations show that activation proceeds through stabilization of the transition-state structure by, amongst other things, hydrogen bonds between the fluorine atom and the water molecules, and not simple transition-state electrostatic stabilization by the solvent even though a mixture of polar solvent (iPrOH/H₂O in a 1:1 ratio) is used (Figure 1).

For its activating role in our system, water appeared to work mostly as a triad of spatially and geometrically well-defined

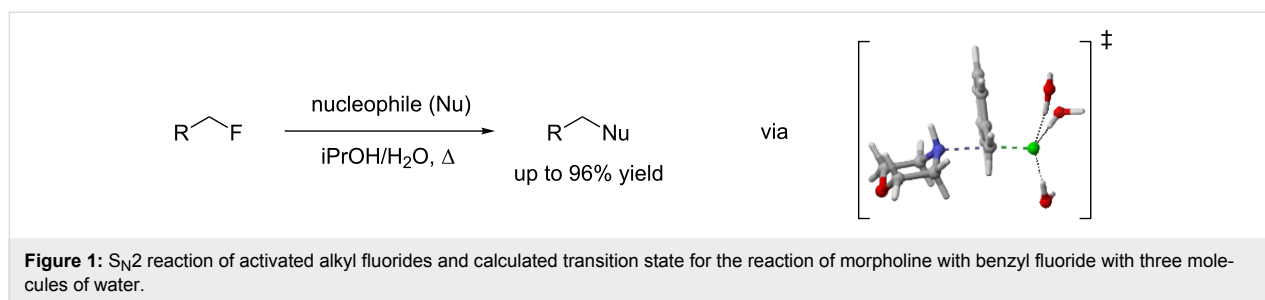

Figure 1: S_N2 reaction of activated alkyl fluorides and calculated transition state for the reaction of morpholine with benzyl fluoride with three molecules of water.

hydrogen bond-donating moieties. We therefore wondered about what would happen if these three moieties (water molecules) were covalently linked together in the form of a triol, which could help the three O–H functionalities to position themselves strategically around the three lone pairs of fluorine, which acts as a hydrogen bond acceptor [18–21] (Figure 2). Revoking the need to have five molecules (substrate, nucleophile and three water molecules) in a precise geometry could also enable a faster reaction with less activating agent, which means we could potentially use the triol as an additive rather than a solvent. Altogether, this strategy would represent a unique metal-free and unprecedented small-molecule-mediated activation of C–F bonds.

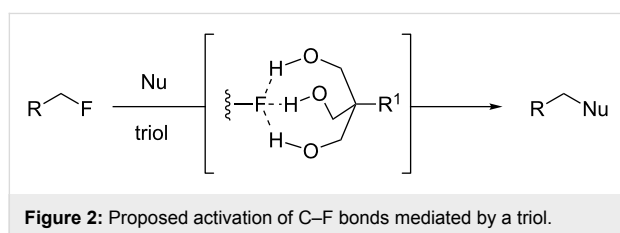

Figure 2: Proposed activation of C–F bonds mediated by a triol.

Herein, we report the feasibility of this concept for the amination of benzylic fluorides, activated alkyl fluorides [22], using 1,1,1-tris(hydroxymethyl)propane as the triol. Furthermore, optimization of the reaction conditions have revealed that the reaction was best run under highly concentrated conditions [23].

Results and Discussion

Our initial investigations were performed using 4-phenylbenzyl fluoride (**1**) [24] as the substrate and morpholine (3 equiv) as the nucleophile at 60 °C for 24 h. Commercially available 1,1,1-tris(hydroxymethyl)propane (**2**) was selected as the triol and was used in a slight excess (1.1 equiv) [25] relative to the substrate. Solvent screening was completed with and without added triol **2** in order to establish its effect on the reactivity and results are reported in Table 1. In water or alcoholic solvent without added triol, low to moderate conversions were observed (12–26%). This was expected since these are all hydrogen bond-donor solvents [17,26]. A low but quantifiable increase in conversion is observed when **2** is added to these reactions, with

the best result (35%) being obtained in water (Table 1, entries 1–3). While the effect of the triol seems minimal, it is possible in these cases that **2**, being both a hydrogen bond donor and acceptor, is engaged in a hydrogen bond network with the solvent, thus limiting its availability for the benzylic fluoride. Interestingly, switching to solvents with better acceptor than donor properties impeded the reaction [26]. Hence, the use of toluene (Table 1, entry 4), EtOAc (Table 1, entry 5), THF (Table 1, entry 6) and DMF (Table 1, entry 7) provided at best traces of the desired benzylic amine **3**. We speculate that the ability of the solvent to interact more strongly with the triol than would the substrate results in no reaction. Finally, "inert" solvents [26,27] such as hexane (Table 1, entry 8) and CH₂Cl₂ (Table 1, entry 9) were investigated. In both cases, little reaction was observed without **2**, and moderate conversions were obtained with **2**. In this instance, the solvent is unable to interact with either the triol or the substrate and the enhanced reactivity in the presence of the triol clearly demonstrates its activating role in this transformation. At this point, since solvents seemed more prone to hinder than help the reaction, we conducted an experiment without any solvent (Table 1, entry 10). Gratifyingly, a 54% conversion was obtained in the presence of **2**, while no conversion at all could be observed without the activating agent. It is important to mention for this entry that even if morpholine is the only liquid component at room temperature, a homogeneous solution is generated around 60 °C by the fusion of 1,1,1-tris(hydroxymethyl)propane (melting point 56–58 °C).

Starting from our solvent-free conditions, which were providing the better results, we envisioned that further optimization was possible to improve the yield (Table 2). First, temperature had an important impact on conversion. Indeed, going from 60 °C (Table 2, entry 1) to 100 °C (Table 2, entry 3) smoothly effected a full conversion. It was also possible to reduce the amount of morpholine used from 3 equiv (Table 2, entry 3) to 2 equiv (Table 2, entry 5) without any impact on the conversion. However, lower amounts (Table 2, entries 6 and 7) resulted in decreased conversions. While a reasonable explanation for the requirement of excess amine would be its role in capturing the HF released during the reaction, control experiments did not

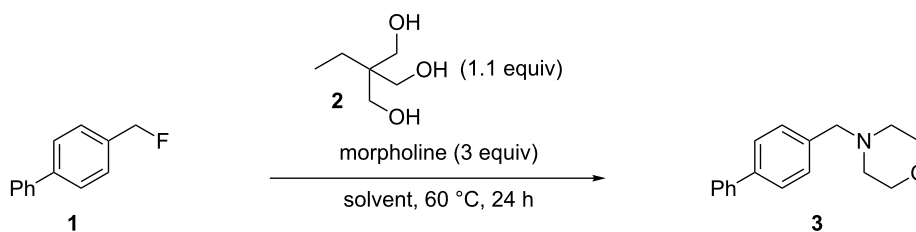
Table 1: Initial screening.

entry	solvent	conversion (%) ^a	
		with 2	without 2
1	H ₂ O	35	26
2	EtOH	29	26
3	iPrOH	16	12
4	toluene	< 3	< 3
5	AcOEt	< 3	< 3
6	THF	< 3	< 3
7	DMF	< 3	< 3
8	hexane	21	< 3
9	CH ₂ Cl ₂	26	< 3
10	–	54	< 3

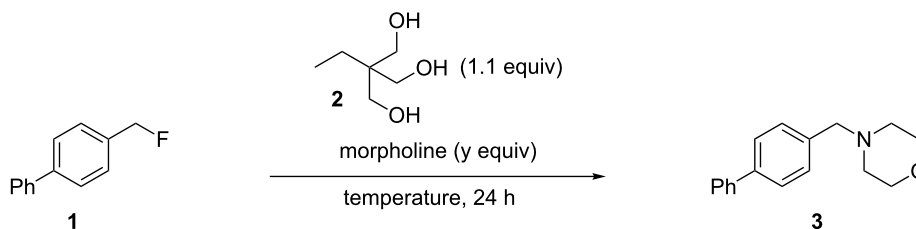
^aDetermined by ¹H NMR analysis of the crude reaction mixture.**Table 2:** Fine-tuning.

entry	temperature	morpholine (equiv)	conversion (%) ^a
1	60	3	54
2	80	3	90
3	100	3	> 97
4	100	2.5	> 97
5	100	2	> 97 (86) ^b
6	100	1.5	91
7	100	1	70
8 ^c	100	1	71
9 ^d	100	1	57
10 ^e	100	1	41

^aDetermined by ¹H NMR analysis of the crude reaction mixture. ^bIsolated yield. ^cEt₃N (1 equiv) was also added. ^dK₃PO₄ (1 equiv) was also added. ^eK₂CO₃ (1 equiv) was also added.

support this proposal. For instance, running the reaction with 1 equiv of morpholine in the presence of 1 equiv of Et₃N provided the same conversion (Table 2, entry 8) while using inorganic bases (1 equiv of either K₃PO₄ or K₂CO₃) gave

lower conversions (Table 2, entries 9 and 10). The reasons for such observations are unclear at present. Nonetheless, conditions presented in entry 5 were chosen for evaluation of the scope.

As shown in Table 3, reactivity is not limited to benzylic fluoride **1** and morpholine. A range of secondary amines can be used, as cyclic (Table 3, entries 1, 2, 5, 6, 8 and 11), acyclic (Table 3, entries 3, 4, 9 and 10) and aromatic (Table 3, entry 7) N-nucleophiles all provide good isolated yields. In the case of *N*-methylaminoethanol, complete selectivity was observed for *N*-benzylation (Table 3, entries 4 and 10). The reaction also tolerates simple electronic variations on the benzylic fluoride,

as the 4-phenyl group can be exchanged for a 4-bromo (Table 3, entries 5–7), 4-*tert*-butyl (Table 3, entries 8–10) or 3-methoxy group (Table 3, entry 11) with only minor impact on the conversion. Overall, conversion into the desired product was superior to 90% for all entries, and only the purification step proved detrimental to the isolated yields. This is further demonstrated by the reaction run at a greater scale which facilitated the purification and resulted in a higher isolated yield (Table 3, entry 1).

Table 3: Substrate scope.

entry	benzyl fluoride	R ¹ R ² NH	product	yield (%) ^a
	1, 4–6		3, 7–16	
1				86 (97) ^b
2	1			79
3	1			83
4	1			77 ^c
5				72
6	4			64
7	4			56
8				86

Table 3: Substrate scope. (continued)

9	5			76
10	5			86 ^c
11				63

^aIsolated yield for reaction on 0.16 mmol scale. ^bIsolated yield for reaction on 0.81 mmol scale. ^cNo product of O-benylation could be detected by ¹H NMR on the crude reaction mixture.

Reactions of secondary benzylic fluorides were unfortunately untractable, and primary aliphatic amines (i.e. *n*-butylamine) generated a mixture of inseparable mono- and dibenylation products (see Supporting Information File 1 for details).

Conclusion

In summary, we have described that according to our previous proposed mechanism for the hydrogen bond-promoted C–F bond activation [17], simultaneous coordination of the three lone pairs of fluorine by a triol (e.g. **2**) permits the nucleophilic substitution of benzylic fluorides by amines under neutral and solvent-free conditions. To further support this hypothesis, solvent properties concerning their hydrogen bond acidity or basicity correlate well with the experimental evidence of reactivity. Investigations concerning the reaction mechanism and precise role of the three hydroxy groups of **2** for the reaction are currently underway in our laboratory.

Supporting Information

Supporting Information File 1

General methods, synthetic procedures, ¹H NMR spectra for known compounds and full characterization of all new compounds.

[<http://www.beilstein-journals.org/bjoc/content/supplementary/1860-5397-9-283-S1.pdf>]

Acknowledgements

This work was supported by the Canada Research Chair Program, the Natural Sciences and Engineering Research Council of Canada, the Canada Foundation for Innovation, the FRQNT Centre in Green Chemistry and Catalysis (CGCC), the

FRQNT Network for Research on Protein Function, Structure, and Engineering (PROTEO) and the Université Laval.

References

- Amii, H.; Uneyama, K. *Chem. Rev.* **2009**, *109*, 2119–2183. doi:10.1021/cr800388c
- Ahrens, M.; Scholz, G.; Braun, T.; Kemnitz, E. *Angew. Chem., Int. Ed.* **2013**, *52*, 5328–5332. doi:10.1002/anie.201300608
- Janjetovic, M.; Träff, A. M.; Ankner, T.; Wettergren, J.; Hilmersson, G. *Chem. Commun.* **2013**, *49*, 1826–1828. doi:10.1039/c3cc37828d
- Azhakar, R.; Roesky, H. W.; Wolf, H.; Stalke, D. *Chem. Commun.* **2013**, *49*, 1841–1843. doi:10.1039/c3cc38669d
- Haufe, G.; Suzuki, S.; Yasui, H.; Terada, C.; Kitayama, T.; Shiro, M.; Shibata, N. *Angew. Chem., Int. Ed.* **2012**, *51*, 12275–12279. doi:10.1002/anie.201207304
- Caputo, C. B.; Stephan, D. W. *Organometallics* **2012**, *31*, 27–30. doi:10.1021/om200885c
- Douvrin, C.; Nagaraja, C. M.; Chen, C.-H.; Foxman, B. M.; Ozerov, O. V. *J. Am. Chem. Soc.* **2010**, *132*, 4946–4953. doi:10.1021/ja100605m
- Zhang, L.; Zhang, W.; Liu, J.; Hu, J. *J. Org. Chem.* **2009**, *74*, 2850–2853. doi:10.1021/jo802819p
- Matsubara, K.; Ishibashi, T.; Koga, Y. *Org. Lett.* **2009**, *11*, 1765–1768. doi:10.1021/OI900208n
- Blessley, G.; Holden, P.; Walker, M.; Brown, J. M.; Gouverneur, V. *Org. Lett.* **2012**, *14*, 2754–2757. doi:10.1021/ol300977f
- Choi, J.; Wang, D. Y.; Kundu, S.; Chohly, Y.; Emge, T. J.; Krogh-Jespersen, K.; Goldman, A. S. *Science* **2011**, *332*, 1545–1548. doi:10.1126/science.1200514
- Hazari, A.; Gouverneur, V.; Brown, J. M. *Angew. Chem., Int. Ed.* **2009**, *48*, 1296–1299. doi:10.1002/anie.200804310
- Pigeon, X.; Bergeron, M.; Barabé, F.; Dubé, P.; Frost, H. N.; Paquin, J.-F. *Angew. Chem., Int. Ed.* **2010**, *49*, 1123–1127. doi:10.1002/anie.200904747
- Paquin, J.-F. *Synlett* **2011**, 289–293. doi:10.1055/s-0030-1259333
- Bergeron, M.; Johnson, T.; Paquin, J.-F. *Angew. Chem., Int. Ed.* **2011**, *50*, 11112–11116. doi:10.1002/anie.201105138

16. Bergeron, M.; Guyader, D.; Paquin, J.-F. *Org. Lett.* **2012**, *14*, 5888–5891. doi:10.1021/ol302802r
17. Champagne, P. A.; Pomarole, J.; Thérien, M.-È.; Benhassine, Y.; Beaulieu, S.; Legault, C. Y.; Paquin, J.-F. *Org. Lett.* **2013**, *15*, 2210–2213. doi:10.1021/ol400765a
18. Schneider, H.-J. *Chem. Sci.* **2012**, *3*, 1381–1394. doi:10.1039/C2SC00764A
19. Giuffredi, G. T.; Gouverneur, V.; Bernet, B. *Angew. Chem., Int. Ed.* **2013**, *52*, 10524–10528. doi:10.1002/anie.201303766
20. Graton, J.; Wang, Z.; Brossard, A.-M.; Gonçalves Monteiro, D.; LeQuestel, J.-Y.; Linclau, B. *Angew. Chem., Int. Ed.* **2012**, *51*, 6176–6180. doi:10.1002/anie.201202059
21. Scerba, M. T.; Leavitt, C. M.; Diener, M. E.; DeBlase, A. F.; Guasco, T. L.; Siegler, M. A.; Bair, N.; Johnson, M. A.; Lectka, T. *J. Org. Chem.* **2011**, *76*, 7975–7984. doi:10.1021/jo2015328
22. Bordwell, F. G.; Brannen, W. T. *J. Am. Chem. Soc.* **1964**, *86*, 4645–4650. doi:10.1021/ja01075a025
23. Walsh, P. J.; Li, H.; Anaya de Parrodi, C. *Chem. Rev.* **2007**, *107*, 2503–2545. doi:10.1021/cr0509556
24. Benzylic fluoride **1** is prepared in two steps with an overall yield of 64% from commercially available 4-biphenylmethanol, see reference [17] for details.
25. Reaction proceeded equally well with 2 equiv of the triol.
26. Kamlet, M. J.; Abboud, J. L. M.; Abraham, M. H.; Taft, R. W. *J. Org. Chem.* **1983**, *48*, 2877–2887. doi:10.1021/jo00165a018
27. Inert solvent refers here to the fact that it is neither a hydrogen-bond donor solvent nor a hydrogen-bond acceptor solvent.

License and Terms

This is an Open Access article under the terms of the Creative Commons Attribution License (<http://creativecommons.org/licenses/by/2.0>), which permits unrestricted use, distribution, and reproduction in any medium, provided the original work is properly cited.

The license is subject to the *Beilstein Journal of Organic Chemistry* terms and conditions: (<http://www.beilstein-journals.org/bjoc>)

The definitive version of this article is the electronic one which can be found at:
[doi:10.3762/bjoc.9.283](https://doi.org/10.3762/bjoc.9.283)

Consecutive cross-coupling reactions of 2,2-difluoro-1-iodoethenyl tosylate with boronic acids: efficient synthesis of 1,1-diaryl-2,2-difluoroethenes

Ju Hee Kim, Su Jeong Choi and In Howa Jeong*

Full Research Paper

Open Access

Address:
Department of Chemistry & Medical Chemistry, Yonsei University,
1 Yonseidaegil, Wonju, Gangwondo 220-710, Republic of Korea

Email:
In Howa Jeong* - jeongih@yonsei.ac.kr

* Corresponding author

Keywords:
boronic acids; cross-coupling reaction; 1,1-diaryl-2,2-difluoroethene;
1,1-difluoro-1,3-dienes; 2,2-difluoro-1-iodoethenyl tosylate;
organo-fluorine

Beilstein J. Org. Chem. **2013**, *9*, 2470–2475.
doi:10.3762/bjoc.9.286

Received: 27 August 2013
Accepted: 22 October 2013
Published: 14 November 2013

This article is part of the Thematic Series "Organo-fluorine chemistry III".

Guest Editor: D. O'Hagan

© 2013 Kim et al; licensee Beilstein-Institut.
License and terms: see end of document.

Abstract

The cross-coupling reactions of 2,2-difluoro-1-iodoethenyl tosylate (**2**) with 2 equiv of boronic acids in the presence of catalytic amounts of Pd(OAc)₂ and Na₂CO₃ afforded the mono-coupled products **3** and **5** in high yields. The use of 4 equiv of boronic acids in the presence of catalytic amount of Pd(PPh₃)₂Cl₂ and Na₂CO₃ in this reaction resulted in the formation of symmetrical di-coupled products **4** in high yields. Unsymmetrical di-coupled products **4** were obtained in high yields from the reactions of **3** with 2 equiv of boronic acids in the presence of catalytic amounts of Pd(OAc)₂ and Na₂CO₃.

Introduction

The synthesis of 2,2-disubstituted-1,1-difluoroethenes have received much attention to synthetic organofluorine chemists in recent years because of their unique chemical reactivities toward nucleophiles to produce monofluorinated organic compounds [1-4], and their biological activity, such as mechanism-based enzyme inhibitors, in the area of medicinal chemistry [5-8]. The 1,1-difluoroethenylidene functionality in these compounds is also known to act as a bioisostere for the carbonyl group of many biologically active compounds [9-12]. Although numerous methods for the preparation of 2,2-disubstituted-1,1-difluoroethenes have been reported in the previous literature [13-22], a consecutive cross-coupling reaction of a proper precursor such as a 1,1-difluoroethenylidene species bearing a

metal functional group, a halogen substituent or a tosylate group at the vinyl carbon will provide a concise and efficient method for the synthesis of 2,2-disubstituted-1,1-difluoroethenes. Burton et al. reported a straightforward method for the preparation of 1,1-diaryl-2,2-difluoroethenes from the consecutive cross-coupling reaction of the 2,2-difluoro-1-bromoethenylzinc reagent with aryl iodides, followed by arylboronic acids [17]. Recently, we also prepared 2,2-difluoro-1-tributylstannylethenyl tosylate and (2,2-difluoroethenyl-idene)bis(tributylstannane) which were utilized in the palladium-catalyzed consecutive cross-coupling reactions with electrophilic aryl iodides or nucleophilic arylstannane reagents to afford the corresponding 1,1-diaryl-2,2-difluoroethenes [20,21]. However,

these previous reagents still have some drawbacks such as the existence of the toxic tributylstannyl group, thermal instability of ethenylzinc reagents and the use of at least one nucleophilic reactive site for the coupling partner. In contrast to these reagents, the 1,1-difluoroethenylidene species bearing both an electrophilic halogen substituent and a tosylate group at the vinyl carbon have not been studied in the cross-coupling reaction with stable and less toxic nucleophilic metal reagents such as aryl- and alkenylboronic acids. Herein, we report a preparation of 2,2-difluoro-1-iodoethenyl tosylate and its cross-coupling reactions with aryl- and alkenylboronic acids to give the corresponding 1,1-difluoroalkenes.

Results and Discussion

Although the chemistry of the 2,2-difluoroethenylidene species as a building block has been well established in recent years, 2,2-difluoro-1-iodoethenyl tosylate (**2**) was not previously prepared. However, we easily synthesized the starting material **2** from the reaction of 2,2,2-trifluoroethyl tosylate (**1**) with 2 equiv of LDA in THF at $-78\text{ }^{\circ}\text{C}$, followed by treatment with 1 equiv of iodine (Scheme 1).

First, we attempted the consecutive palladium-catalyzed cross-coupling reaction of **2** with different arylboronic acids to afford unsymmetrical 1,1-diaryl-2,2-difluoroethenes. Since the use of a proper base in the Suzuki–Miyaura reaction is an important factor to increase the yield of coupled product, we screened bases to get the optimized reaction conditions. When **2** was

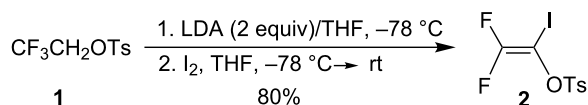

Scheme 1: Preparation of 2,2-difluoro-1-iodoethenyl tosylate (**2**).

reacted with 1 equiv of phenylboronic acid in the presence of 5 mol % of $\text{Pd}(\text{OAc})_2$ and Cs_2CO_3 (2 equiv) in methanol at room temperature for 15 h, mono- and di-coupled products **3a** and **4a** were obtained in 21% and 10% yields, respectively, along with a small amount of the self-coupled product (less than 5%) and reduced product. The use of 2 equiv of phenylboronic acid in the same reaction increased the yield of **3a** (38%) and **4a** (19%). However, the use of high molecular amounts of Pd catalyst did not improve the yield of **3**. The same reaction was performed with K_2CO_3 instead of Cs_2CO_3 as a base to give **3a** and **4a** in 56% and 16% yields. The use of K_3PO_4 in this reaction provided similar results. Finally, the optimized reaction condition was achieved by using Na_2CO_3 as a base, in which only mono-coupled product **3a** was obtained in 92% yield along with the self-coupled product derived from the excess boronic acid. When the reaction was performed in the presence of 5% $\text{Pd}(\text{PPh}_3)_2\text{Cl}_2$ or $\text{Pd}(\text{CH}_3\text{CN})_2\text{Cl}_2$ instead of $\text{Pd}(\text{OAc})_2$, di-coupled product **4a** was always formed in 6–13% yield. Optimization of the cross-coupling reaction of **2** with phenylboronic acid is summarized in Table 1.

Table 1: Optimization of the cross-coupling reaction of **2** with phenylboronic acid.

Entry	Pd catalyst	X (equiv)	Y (mol %)	Base	Yield (%) ^a	
					3a	4a
1	$\text{Pd}(\text{OAc})_2$	1	5	Cs_2CO_3	21	10
2	$\text{Pd}(\text{OAc})_2$	2	5	Cs_2CO_3	38	19
3	$\text{Pd}(\text{OAc})_2$	3	5	Cs_2CO_3	18	40
4	$\text{Pd}(\text{OAc})_2$	2	10	Cs_2CO_3	30	24
5	$\text{Pd}(\text{OAc})_2$	2	5	K_2CO_3	56	16
6	$\text{Pd}(\text{OAc})_2$	2	5	K_3PO_4	54	17
7	$\text{Pd}(\text{OAc})_2$	2	5	Na_2CO_3	92	– ^b
8	$\text{Pd}(\text{PPh}_3)_2\text{Cl}_2$	2	5	Na_2CO_3	78	6
9	$\text{Pd}(\text{CH}_3\text{CN})_2\text{Cl}_2$	2	5	Na_2CO_3	55	13

^aIsolated yield. ^bA trace amount of **4a** was obtained.

After the successful coupling reaction of **2** with phenylboronic acid under the optimized reaction conditions, the same reaction was performed with other arylboronic acids bearing a proton, fluoro, chloro, methyl, methoxy and trifluoromethyl on the *ortho*-, *meta*- or *para*-position of the benzene ring. Reactions were successful with both electron-donating and electron-withdrawing arylboronic acids to produce the corresponding 2,2-difluoro-1-arylethenyl tosylates **3** in excellent isolated yields. Especially, the coupling reactions with arylboronic acids having an electron-donating group at the *ortho*-position of the benzene ring also provided the corresponding coupled products **3l–n** in good yields. The cross-coupling reactions of **2** with arylboronic acids are summarized in Table 2.

Direct diarylation reactions of **2** with arylboronic acids were also performed because di-coupled product **4a** was formed in a mono-arylation reaction (Table 1) and also a recent work showed a successful cross-coupling reaction of nonfluorinated enol tosylates with a variety of arylboronic acids [23]. We attempted a direct diarylation reaction of **2** with phenylboronic acid to establish the optimized reaction conditions. Initial reaction of **2** with 3 equiv of phenylboronic acid in the presence of 5 mol % of Pd(OAc)₂ and 2 equiv of Na₂CO₃ in MeOH at room temperature for 22 h afforded the di-coupled product **4a** in 30% yield. The yield of **4a** was increased to 39% using 4 equiv of phenylboronic acid in this reaction. When the reaction was

performed with K₂CO₃ or K₃PO₄ as a base under the same reaction conditions, the desired product **4a** was obtained in up to 49–52% yield. The use of more soluble Cs₂CO₃ resulted in the formation of **4a** in 61% yield. Increasing the reaction temperature did not improve the of yield of **4a**. We also examined the effect of the palladium catalyst in this reaction. Therefore, the same reaction was performed in the presence of 5 mol % of Pd(PPh₃)₂Cl₂ instead of Pd(OAc)₂, in which **4a** was obtained in 75% yield. Other palladium catalysts such as Pd(CH₃CN)₂Cl₂ did not cause to improve the yield of **4a**. Optimization of the di-coupling reaction of **2** with phenylboronic acid is summarized in Table 3.

Diarylation reactions of **2** with arylboronic acids substituted by fluoro, chloro, methyl, methoxy, nitro and trifluoromethyl substituent at the *meta*- or *para*-position of the benzene ring proceeded well under the optimized reaction conditions to give the corresponding symmetrical di-coupled products **4b–k** in 51–86% yield. However, coupling reactions with arylboronic acids having a substituent such as chloro, methyl or a methoxy group at the *ortho*-position of the benzene ring to produce the di-coupled products **4l–n** were unsuccessful. This result probably indicates that the coupling process could be affected by steric hindrance in the second coupling reaction step. The di-coupling reactions of **2** with arylboronic acids are summarized in Table 4.

Table 2: Preparation of 2,2-difluoro-1-arylethenyl tosylate **3**.

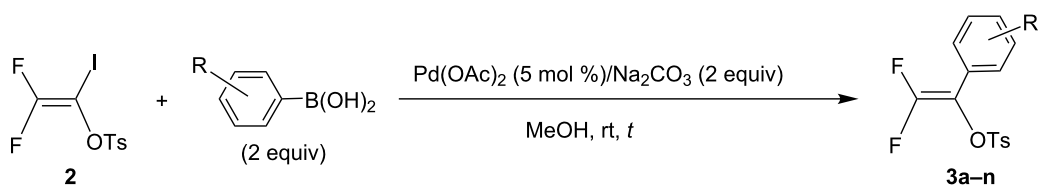

Compound	R	t (h)	Yield (%) ^a
3a	H	15	92
3b	<i>p</i> -F	15	81
3c	<i>p</i> -Cl	14	84
3d	<i>p</i> -CH ₃	14	79
3e	<i>p</i> -OCH ₃	14	65
3f	<i>p</i> -CF ₃	15	85
3g	<i>m</i> -F	16	72
3h	<i>m</i> -Cl	16	76
3i	<i>m</i> -CH ₃	16	82
3j	<i>m</i> -OCH ₃	18	74
3k	<i>m</i> -CF ₃	18	80
3l	<i>o</i> -CH ₃	18	65
3m	<i>o</i> -OCH ₃	18	61
3n	<i>o</i> -Cl	18	68

^aIsolated yield.

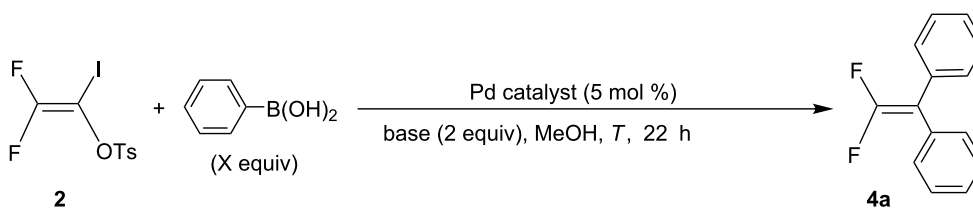
Table 3: Optimization of the di-coupling reaction of **2** with phenylboronic acid.

Entry	Pd catalyst	X (equiv)	Base	T (°C)	Yield (%) ^a
1	Pd(OAc) ₂	3	Na ₂ CO ₃	rt	30
2	Pd(OAc) ₂	4	Na ₂ CO ₃	rt	39
3	Pd(OAc) ₂	4	K ₂ CO ₃	rt	52
4	Pd(OAc) ₂	4	K ₃ PO ₄	rt	49
5	Pd(OAc) ₂	4	Cs ₂ CO ₃	rt	61
6	Pd(OAc) ₂	4	Cs ₂ CO ₃	50	58
7	Pd(PPh ₃) ₂ Cl ₂	4	Cs ₂ CO ₃	rt	75
8	Pd(CH ₃ CN) ₂ Cl ₂	4	Cs ₂ CO ₃	rt	21

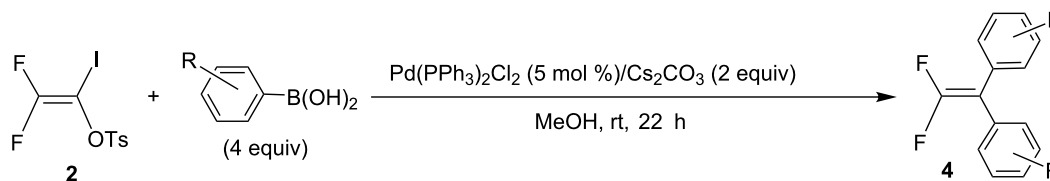
^aIsolated yield of **4a**.**Table 4:** Preparation of symmetrical 1,1-diaryl-2,2-difluoroethenes **4**.

Compound No	R	Yield (%) ^a
4a	H	75
4b	<i>p</i> -F	83
4c	<i>p</i> -Cl	86
4d	<i>p</i> -CH ₃	74
4e	<i>p</i> -OCH ₃	60
4f	<i>p</i> -NO ₂	73
4g	<i>m</i> -F	58
4h	<i>m</i> -Cl	51
4i	<i>m</i> -CH ₃	56
4j	<i>m</i> -OCH ₃	53
4k	<i>m</i> -CF ₃	60
4l	<i>o</i> -CH ₃	– ^b
4m	<i>o</i> -OCH ₃	– ^b
4n	<i>o</i> -Cl	– ^b

^aIsolated yield. ^bA trace amount of product was obtained.

Unsymmetrical 1,1-diaryl-2,2-difluoroethenes can be prepared from the coupling reaction of mono-coupled tosylates **3** with arylboronic acids under similar reaction conditions. Therefore, the cross-coupling reaction of **3a** with 2 equiv of *p*-chloro-

phenylboronic acid in the presence of 5 mol % Pd(PPh₃)₂Cl₂ and 2 equiv of Cs₂CO₃ in MeOH at room temperature for 12 h afforded 1,1-diaryl-2,2-difluoroethene **4o** in 89% yield. The similar reactions of **3a** with arylboronic acids having a

substituent such as fluoro, methyl, methoxy, and trifluoromethyl at the *meta*- or *para*-position of the benzene ring also provided the corresponding 1,1-diaryl-2,2-difluoroethenes **4p–v** in 75–90% yields. The coupling reaction between **3c** and *m*-methylphenylboronic acid also resulted in the formation of **4w** in 79% yield. Similarly, **3k** having an electron-withdrawing group on the benzene ring was also reacted with *p*-methylphenylboronic acid to yield **4x** in 70% yield. Table 5 summarizes the results of the coupling reactions of **3** with several arylboronic acids to give unsymmetrical 1,1-diaryl-2,2-difluoroethenes.

The successful cross-coupling reaction of **2** with arylboronic acids prompted us to examine similar coupling reactions with

alkenylboronic acids. The same reaction conditions of the mono-coupling reaction of **2** with arylboronic acid was applied to the alkenylation of **2**. Therefore, the cross-coupling reaction of **2** with *trans*-2-phenylethenylboronic acid in the presence of 5 mol % of Pd(OAc)₂ and 2 equiv of Na₂CO₃ in MeOH at room temperature for 15 h provided the cross-coupled product **5a** in 85% yield. The similar reaction of **2** with *trans*-oct-1-enylboronic acid afforded the cross-coupled product **5b** in 81% yield. The cross-coupling reactions of **2** with alkenylboronic acids are summarized in Table 6.

Conclusion

In summary, we have successfully developed the consecutive cross-coupling reactions of 2,2-difluoro-1-iodoethenyl tosylate

Table 5: Preparation of unsymmetrical 1,1-diaryl-2,2-difluoroethenes **4**.

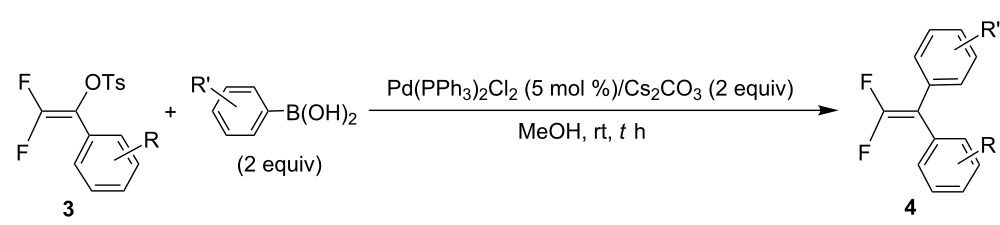

Compound No	R	R'	T (h)	Yield (%) ^a
4o	H	<i>p</i> -Cl	12	89
4p	H	<i>p</i> -F	12	90
4q	H	<i>p</i> -CH ₃	12	81
4r	H	<i>p</i> -OCH ₃	14	79
4s	H	<i>p</i> -CF ₃	18	82
4t	H	<i>m</i> -Cl	12	81
4u	H	<i>m</i> -CH ₃	14	77
4v	H	<i>m</i> -CF ₃	14	75
4w	<i>p</i> -Cl	<i>m</i> -CH ₃	12	79
4x	<i>m</i> -CF ₃	<i>p</i> -CH ₃	12	70

^aIsolated yield.

Table 6: The cross-coupling reactions of **2** with alkenylboronic acids.

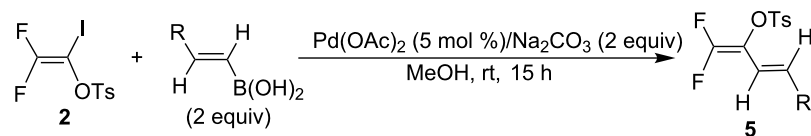

Compound No.	R	Yield (%) ^a
5a	Ph	85
5b	CH ₃ (CH ₂) ₅	81

^aIsolated yield.

(2) with arylboronic or alkenylboronic acids in the presence of a suitable Pd catalyst and a base to afford 2,2-diaryl-1,1-difluoroethenes. The developed method provides synthetically useful advantages such as a straightforward procedure to give symmetrical and unsymmetrical 2,2-diaryl-1,1-difluoroethenes and the use of a less toxic reagent such as boronic acid.

Supporting Information

Supporting Information File 1

Experimental details, full spectroscopic data and spectra.

[<http://www.beilstein-journals.org/bjoc/content/supplementary/1860-5397-9-286-S1.pdf>]

Acknowledgements

This work was supported by a Basic Research Grant (2012-0008411) funded by the National Research Foundation of Korea.

References

1. Ichikawa, J.; Wada, Y.; Okauchi, T.; Minami, T. *Chem. Commun.* **1997**, 1537–1538. doi:10.1039/a703110f
2. Ichikawa, J.; Wada, Y.; Fujiwara, M.; Sakoda, K. *Synthesis* **2002**, 1917–1936. doi:10.1055/s-2002-33912
3. Ichikawa, J.; Miyazaki, H.; Sakoda, K.; Wada, Y. *J. Fluorine Chem.* **2004**, *125*, 585–593. doi:10.1016/j.fluchem.2004.01.004
4. Ichikawa, J.; Sakoda, K.; Moriyama, H.; Wada, Y. *Synthesis* **2006**, 1590–1598. doi:10.1055/s-2006-926458
5. McDonald, I. A.; Lacoste, J. M.; Bey, P.; Palfreyman, M. G.; Ziena, M. *J. Med. Chem.* **1985**, *28*, 186–193. doi:10.1021/jm00380a007
6. Madden, B. A.; Prestwich, D. G. *Bioorg. Med. Chem. Lett.* **1997**, *7*, 309–314. doi:10.1016/S0960-894X(97)00008-5
7. Weintraub, P. M.; Holland, A. K.; Gate, C. A.; Moore, W. R.; Resvick, R. J.; Bey, P.; Peet, N. P. *Bioorg. Med. Chem.* **2003**, *11*, 427–431. doi:10.1016/S0968-0896(02)00434-0
8. Landelle, G.; Turcotte-Savard, M.-O.; Marterer, J.; Champagne, P. A.; Paquin, J.-F. *Org. Lett.* **2009**, *11*, 5406–5409. doi:10.1021/ol9022672
9. Bobek, M.; Kavai, I.; De Clercq, E. *J. Med. Chem.* **1987**, *30*, 1494–1497. doi:10.1021/jm00391a036
10. Moore, W. R.; Schatzman, G. L.; Jarvi, E. T.; Gross, R. S.; McCarthy, J. R. *J. Am. Chem. Soc.* **1992**, *114*, 360–361. doi:10.1021/ja00027a056
11. Altenburger, J.-M.; Lassalle, G. Y.; Matrougui, M.; Galtier, D.; Jetha, J.-C.; Bocskai, Z.; Berry, C. N.; Lunven, C.; Lorrain, J.; Herault, J.-P.; Schaeffer, P.; O'Connor, S. E.; Herbert, J.-M. *Bioorg. Med. Chem.* **2004**, *12*, 1713–1730. doi:10.1016/j.bmc.2004.01.016
12. Ichikawa, J. *J. Synth. Org. Chem., Jpn.* **2010**, *68*, 1175–1184. doi:10.5059/yukigoseikyokaishi.68.1175
13. Lee, J.; Tsukazaki, M.; Snieckus, V. *Tetrahedron Lett.* **1993**, *34*, 415–418. doi:10.1016/0040-4039(93)85090-J
14. Ichikawa, J. *J. Fluorine Chem.* **2000**, *105*, 257–263. doi:10.1016/S0022-1139(99)00268-7
15. DeBoos, G. A.; Fullbrook, J. J.; Percy, J. M. *Org. Lett.* **2001**, *3*, 2859–2861. doi:10.1021/ol010135p
16. Ichikawa, J.; Ishibashi, Y.; Fukui, H. *Tetrahedron Lett.* **2003**, *44*, 707–710. doi:10.1016/S0040-4039(02)02652-7
17. Raghavanpillai, A.; Burton, D. J. *J. Org. Chem.* **2006**, *71*, 194–201. doi:10.1021/jo051842p
18. Choi, J. H.; Jeong, I. H. *Tetrahedron Lett.* **2008**, *49*, 952–955. doi:10.1016/j.tetlet.2007.12.028
19. Zhao, Y.; Huang, W.; Zhu, L.; Hu, J. *Org. Lett.* **2010**, *12*, 1444–1447. doi:10.1021/ol100090r
20. Han, S. Y.; Jeong, I. H. *Org. Lett.* **2010**, *12*, 5518–5521. doi:10.1021/ol1024037
21. Han, S. Y.; Lee, H. Y.; Jeon, J. H.; Jeong, I. H. *Tetrahedron Lett.* **2012**, *53*, 1833–1836. doi:10.1016/j.tetlet.2012.01.127
22. Turcotte-Savard, M.-O.; Paquin, J.-F. *Org. Biomol. Chem.* **2013**, *11*, 1367–1375. doi:10.1039/c2ob27221k
23. Steinhuebel, D.; Baxter, J. M.; Palucki, M.; Davies, I. W. *J. Org. Chem.* **2005**, *70*, 10124–10127. doi:10.1021/jo051590s

License and Terms

This is an Open Access article under the terms of the Creative Commons Attribution License (<http://creativecommons.org/licenses/by/2.0>), which permits unrestricted use, distribution, and reproduction in any medium, provided the original work is properly cited.

The license is subject to the *Beilstein Journal of Organic Chemistry* terms and conditions: (<http://www.beilstein-journals.org/bjoc>)

The definitive version of this article is the electronic one which can be found at: [doi:10.3762/bjoc.9.286](https://doi.org/10.3762/bjoc.9.286)

Recent advances in transition metal-catalyzed Csp²-monofluoro-, difluoro-, perfluoromethylation and trifluoromethylthiolation

Grégory Landelle^{1,§}, Armen Panossian^{1,§}, Sergiy Pazenok²,
Jean-Pierre Vors³ and Frédéric R. Leroux^{*1,§}

Review

Open Access

Address:

¹CNRS-Université de Strasbourg, UMR 7509, SynCat, ECPM, 25 Rue Becquerel, 67087 Strasbourg Cedex 02, France, ²Bayer CropScience AG, Alfred-Nobel-Strasse 50, 40789 Monheim, Germany and ³Bayer SAS, 14 impasse Pierre Baizet, 69263 Lyon, Cedex 09, France

Email:

Frédéric R. Leroux* - frederic.leroux@unistra.fr

* Corresponding author

§ <http://www.synocat.org>

Keywords:

catalysis; cross-coupling; difluoromethylation; fluorine; monofluoromethylation; organo-fluorine; transition metal; trifluoromethylation; trifluoromethylthiolation

Beilstein J. Org. Chem. **2013**, *9*, 2476–2536.

doi:10.3762/bjoc.9.287

Received: 30 July 2013

Accepted: 10 October 2013

Published: 15 November 2013

This article is part of the Thematic Series "Organo-fluorine chemistry III".

Guest Editor: D. O'Hagan

© 2013 Landelle et al; licensee Beilstein-Institut.

License and terms: see end of document.

Abstract

In the last few years, transition metal-mediated reactions have joined the toolbox of chemists working in the field of fluorination for Life-Science oriented research. The successful execution of transition metal-catalyzed carbon–fluorine bond formation has become a landmark achievement in fluorine chemistry. This rapidly growing research field has been the subject of some excellent reviews. Our approach focuses exclusively on transition metal-catalyzed reactions that allow the introduction of –CFH₂, –CF₂H, –C_nF_{2n+1} and –SCF₃ groups onto sp² carbon atoms. Transformations are discussed according to the reaction-type and the metal employed. The review will not extend to conventional non-transition metal methods to these fluorinated groups.

Review

Introduction

The incorporation of fluorine or fluorinated moieties into organic compounds plays a key role in Life-Science oriented research as often-profound changes of the physico-chemical and biological properties can be observed [1-6]. As a consequence, organofluorine chemistry has become an integral part of phar-

maceutical [6-16] and agrochemical research [16-20]. About 20% of all pharmaceuticals and roughly 40% of agrochemicals are fluorinated. Perfluoroalkyl substituents are particularly interesting as they often lead to a significant increase in lipophilicity and thus bioavailability albeit with a modified

stability. Therefore, it is of continual interest to develop new, environmentally benign methods for the introduction of these groups into target molecules. Recent years have witnessed exciting developments in mild catalytic fluorination techniques. In contrast to carbon–carbon, carbon–oxygen and carbon–nitrogen bond formations, catalytic carbon–fluorine bond formation remained an unsolved challenge, mainly due to the high electronegativity of fluorine, its hydration and thus reduced nucleophilicity [21]. The importance of this developing research field is reflected by the various review articles which have been published dealing with transition metal mediated or catalyzed fluorination [22–24], difluoromethylation [24], and trifluoromethylation reactions [22–28].

The present review focuses on fundamental achievements in the field of transition metal-catalyzed mono-, di- and trifluoromethylation as well as trifluoromethylthiolation of sp^2 carbon atoms. We present the different developments according to the reaction-type and the nature of the transition metal.

1 Catalytic monofluoromethylation

Monofluoromethylated aromatics find application in various pharmaceutical [29–32] and agrochemical products [18].

Although numerous methods for the catalytic introduction of a trifluoromethyl group onto aryl moieties have been reported in the literature [27,33–41], the incorporation of partially fluorinated methyl groups is still underdeveloped [42,43]. In most cases transition metals have to be employed in stoichiometric amounts.

1.1 Palladium catalysis

The first monofluoromethylation was reported by M. Suzuki (Scheme 1) [44]. Fluoromethyl iodide was reacted with pinacol phenylboronate (40 equiv) affording the coupling product in low yield (47%).

The Pd-catalyzed α -arylation of α -fluorocarbonyl compounds affording various quaternary α -aryl- α -fluorocarbonyl derivatives has been reported by J. F. Hartwig [45], J. M. Shreeve [46] and further investigated and generalized to both open-chain and cyclic α -fluoroketones by F. L. Qing [47,48]. However, further

decarbonylation to the monofluoromethyl group proved difficult.

1.2 Copper catalysis

Recently a copper-catalyzed monofluoromethylation was described by J. Hu. Aryl iodides were submitted to a Cu-catalyzed (CuTC = copper thiophene-2-carboxylate) debenzoylative fluoroalkylation with 2-PySO₂CHFCOR followed by desulfonylation (Scheme 2) [49]. It has been shown that the (2-pyridyl)sulfonyl moiety is important for the Cu-catalysis.

2 Catalytic difluoromethylation

The synthesis of difluoromethylated aromatics attracted considerable interest in recent years due to their potential pharmacological and agrochemical activity [42,50–56].

2.1 Copper catalysis

In contrast to widely used stoichiometric copper-mediated trifluoromethylations and the recent results of the Cu-catalyzed reaction described above, that of difluoromethylation has been more slowly developed. This is probably due to the lack of thermal stability of CuCHF₂ [42]. To the best of our knowledge, the direct cross-coupling of CuCHF₂ with aromatic halides has not been reported. H. Amii reported on the reaction of aryl iodides with α -silyldifluoroacetates in the presence of a catalytic amount of CuI (Scheme 3). The corresponding aryl difluoroacetates have been obtained in moderate to good yields and afforded, after subsequent hydrolysis of the aryl difluoroacetates and KF-promoted decarboxylation, a variety of difluoromethyl aromatics [57].

Unlike previous protocols where an excess of copper is required, this approach presents some advantages such as: (i) stability and availability of the required 2-silyl-2,2-difluoroacetates from trifluoroacetates or chlorodifluoroacetates [58–60]; (ii) high functional group tolerance as the reactions proceed smoothly under mild conditions; and (iii) the reaction being catalytic in copper.

J. Hu described the Lewis acid (CuF₂·2H₂O) catalyzed vinylic C–CHF₂ bond formation of α,β -unsaturated carboxylic acids through decarboxylative fluoroalkylation (Table 1) [61]. A wide

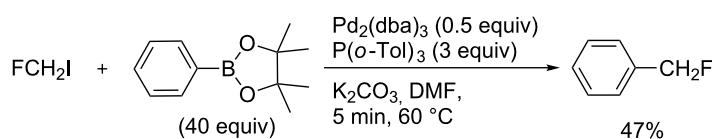

Scheme 1: Pd-catalyzed monofluoromethylation of pinacol phenylboronate [44].

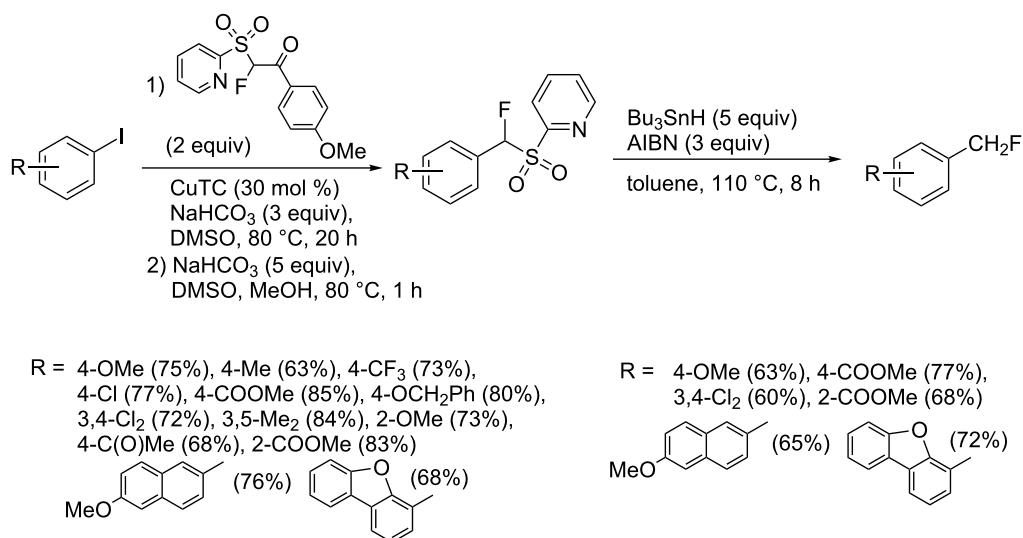

Scheme 2: Cu-catalyzed monofluoromethylation with 2-PySO₂CHFCOR followed by desulfonylation [49].

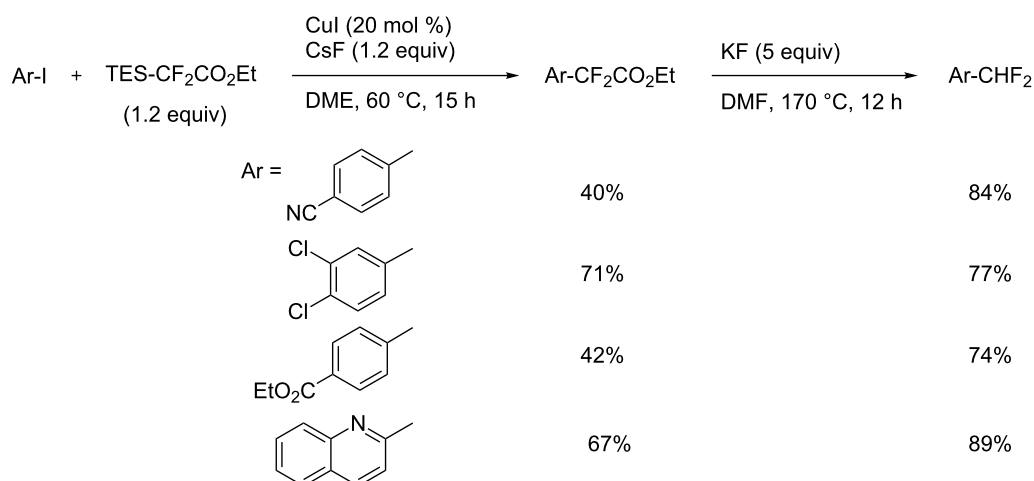

Scheme 3: Cu-catalyzed difluoromethylation with α -silyldifluoroacetates [57].

range of α,β -unsaturated carboxylic acids afforded the corresponding difluoromethylated alkenes in high yields and with excellent *E/Z* selectivity.

The putative mechanism for this copper-catalyzed decarboxylative fluoro-alkylation involves the iodine–oxygen bond cleavage of Togni's reagent in presence of the copper catalyst to produce a highly electrophilic species (intermediate **A**). Then, the acrylate derivative coordinates to the iodonium salt **A** leading to intermediate **B** with generation of hydrogen fluoride, followed by an intramolecular reaction between the double bond and the iodonium ion to provide intermediate **C**. The pres-

ence of HF in the reaction medium promotes the decarboxylation step in intermediate **C**, and subsequent reductive elimination leads to the formation of the thermodynamically stable *E*-alkene. Finally, protonation of intermediate **E** regenerates the copper catalyst, thus allowing the catalytic turnover (Figure 1).

2.2 Iron catalysis

Similarly to the work of J. Hu and colleagues using copper catalysis, the group of Z.-Q. Liu reported on the decarboxylative difluoromethylation of α,β -unsaturated carboxylic acids. However, the latter used iron(II) sulfate as catalyst and zinc bis(difluoromethanesulfinate) as the fluoroalkyl transfer

reagent. A handful of β -difluoromethylstyrenes were obtained in moderate yields and with complete diastereoselectivity (Scheme 4) [62].

3 Catalytic perfluoroalkylation

The transition metal mediated trifluoromethylation of aromatic compounds has been extensively reviewed in recent years by

Table 1: Cu-catalyzed C–CHF₂ bond formation of α,β -unsaturated carboxylic acids through decarboxylative fluoroalkylation [61].

					
Compound	Yield (%)	Compound	Yield (%)	Compound	Yield (%)
	70		88		86
	90		87		91
	86		87		86
	82		76		60
	60		90		84
	84		73		70

Table 1: Cu-catalyzed C–CHF₂ bond formation of α,β -unsaturated carboxylic acids through decarboxylative fluoroalkylation [61]. (continued)**Figure 1:** Mechanism of the Cu-catalyzed C–CHF₂ bond formation of α,β -unsaturated carboxylic acids through decarboxylative fluoroalkylation [61].

several authors [23–28,63,64]. Nevertheless, aromatic trifluoromethylations catalytic in metal are still rare. This section reviews recent advances in this area and classifies the reactions according to metal type and reaction mechanism. One can identify two major approaches, trifluoromethylation via cross-coupling reactions or the more recent C–H functionalization.

3.1 Palladium catalysis

3.1.1 Trifluoromethylation of Csp²–X bonds (X = halogen or sulfonate) by means of a nucleophilic CF₃-source. The first Pd-catalyzed aromatic trifluoromethylation of aryl chlorides with a nucleophilic source of CF₃ has been reported in 2010 by S. L. Buchwald et al. (Table 2) [38]. An excess of expensive (trifluoromethyl)triethylsilane (TESCF₃) in combination with potassium fluoride was used to provide the expected trifluoro-

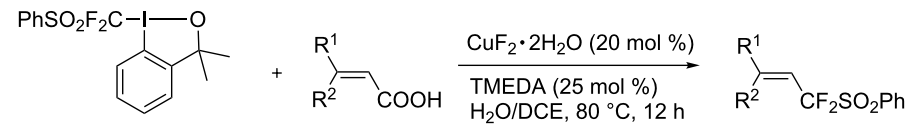
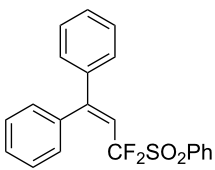
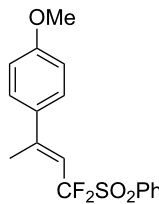
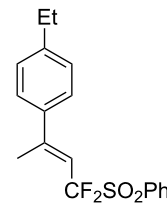
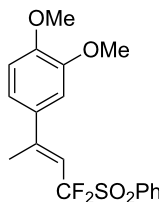
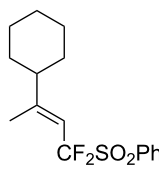
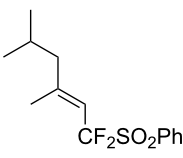
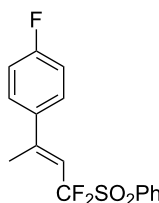
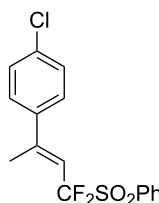
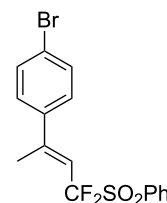
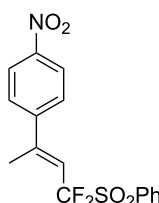
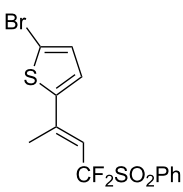
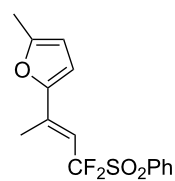
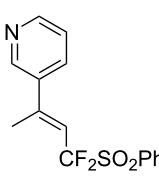
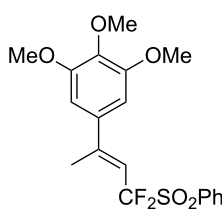
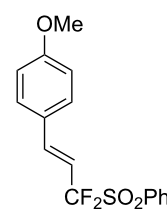
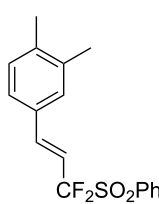
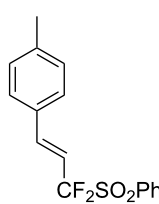
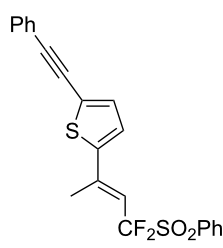
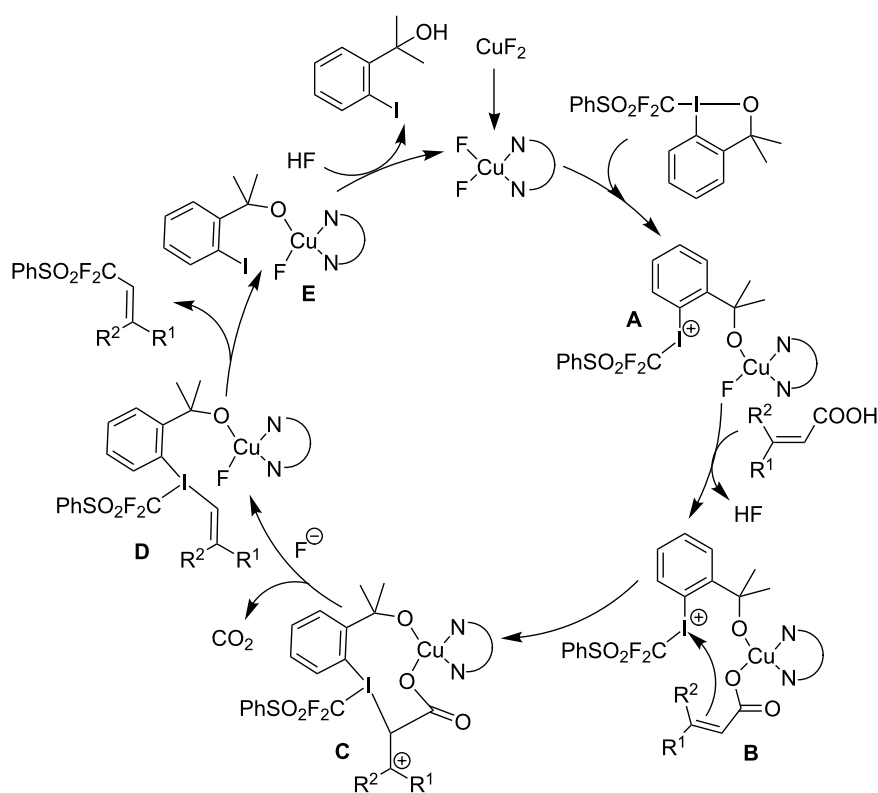
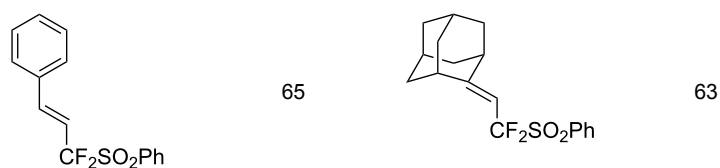
methylated arenes in good yields, and a variety of functional groups is tolerated under the mild conditions of the process. The reaction with aryl bromides or triflates is less efficient. The success of this Pd-catalyzed trifluoromethylation is due to highly hindered phosphorus ligands like BrettPhos, which facilitate the reductive elimination step. However, the phosphine was changed for the less bulky ligand RuPhos for the reaction with *ortho*-substituted aryl chlorides. The authors presume a Pd(0)/Pd(II) catalytic cycle, which is supported by preliminary mechanistic studies.

In 2011, B. S. Samant and G. W. Kabalka developed improved conditions for the trifluoromethylation of aryl halides by carrying out the reaction in sodium dodecyl sulfate (SDS) and toluene, and by using TMSCF₃ as a cheaper trifluoro-

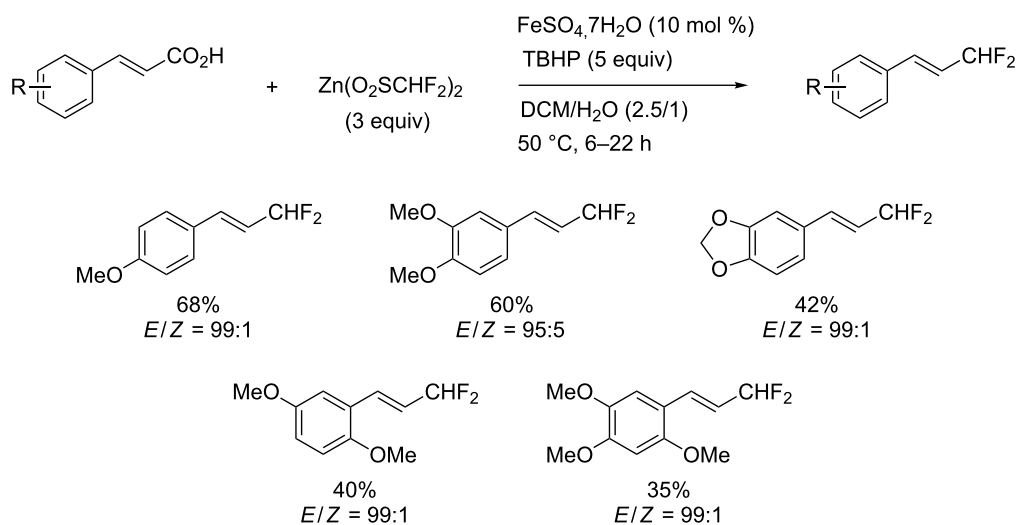

Scheme 4: Fe-catalyzed decarboxylative difluoromethylation of cinnamic acids [62].

Table 2: Pd-catalyzed trifluoromethylation of aryl and heteroaryl chlorides [38].

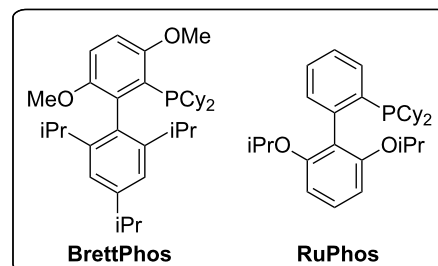
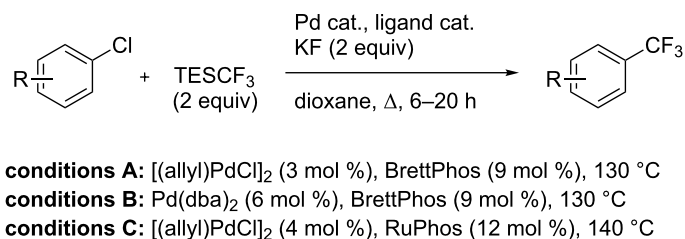

Compound	Conditions	Yield (%)	Compound	Conditions	Yield (%)
	A	80		A	83
	A	85		A	72
	A	94		A	70
	A	82		A	90

Table 2: Pd-catalyzed trifluoromethylation of aryl and heteroaryl chlorides [38]. (continued)

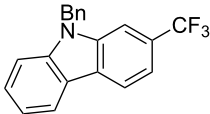
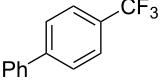
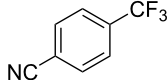
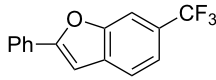
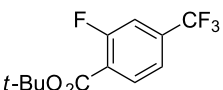
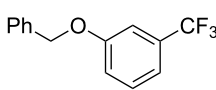
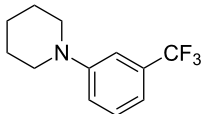
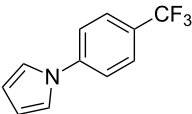
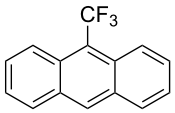
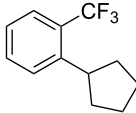
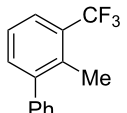
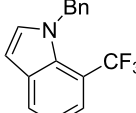
	A	76		A	84
	B	72		B	87
	B	72		B	88
	B	84		B	84
	C	90		C	77
	C	87		C	78

methylating agent [65]. The reverse micelles appear to prevent the decomposition of TMSCF_3 and provide an effective reaction site for oxidative addition of Ar-X and the $\text{Pd}(0)$ catalyst, increasing the yields and allowing the use of aryl bromides as starting materials (Table 3). Free alcohols and amines are

compatible with the reaction conditions, which was not the case with S. L. Buchwald's methodology.

For the metal-catalyzed perfluoroalkylation of sp^2 carbons, vinyl sulfonates represent valuable alternative coupling part-

Table 3: Pd-catalyzed trifluoromethylation of bromoaromatic compounds in micellar conditions [65].

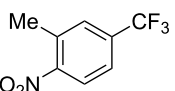
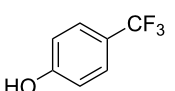
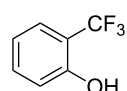
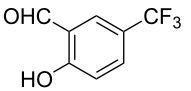
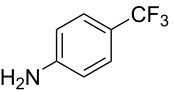
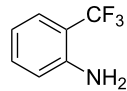
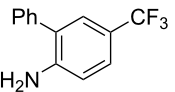
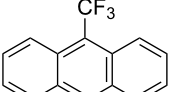
$\text{R-C}_6\text{H}_4\text{-Br} + \text{TMSCF}_3 \xrightarrow[\text{SDS (60 mM), toluene, 110 }^\circ\text{C, 12 h}]{\text{[cinnamylPdCl]}_2 \text{ (10 mol \%), BrettPhos (10 mol \%), CsF (2 equiv)}} \text{R-C}_6\text{H}_4\text{-CF}_3$					
Compound	Yield (%)	Compound	Yield (%)	Compound	Yield (%)
	77		70		74
	68		71		70
	72		80		

ners to vinyl halides, given that they can be prepared in a straightforward manner from readily available alcoholic precursors. In 2011, the group of S. L. Buchwald described a catalytic system to convert cyclic vinyl triflates or nonaflates to their trifluoromethylated equivalents (Table 4) [66]. Ruppert's reagent was used as the CF_3^- precursor in a combination with potassium fluoride as an activator for the reaction with vinyl triflates, while TESCF_3 and rubidium fluoride gave better results for nonaflate electrophiles. Otherwise, the scope is actually limited

to six-membered vinyl sulfonates, and moderate yields were obtained with 2-alkyl substituted cyclohexenyl substrates.

3.1.2 Trifluoromethylation by means of C–H activation and an electrophilic CF_3 -source. In 2010, J.-Q. Yu and coworkers reported on the first Pd-catalyzed trifluoromethylation at C–H positions in aromatic compounds (Table 5) [67]. $\text{Pd}(\text{OAc})_2$ (10 mol %) was used as the catalyst, and Umemoto's sulfonium tetrafluoroborate salt as the CF_3 source rather than its triflate

Table 4: Pd-catalyzed trifluoromethylation of vinyl sulfonates [66].

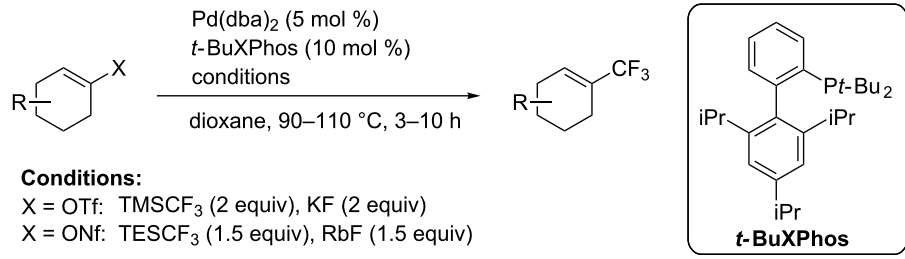
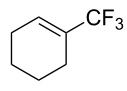
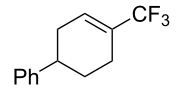
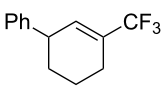
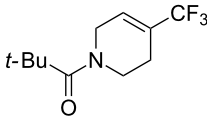
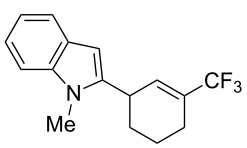
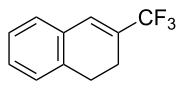
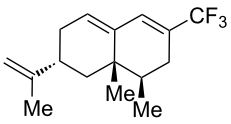
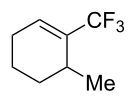
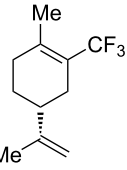
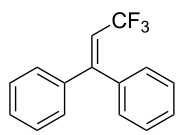
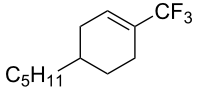
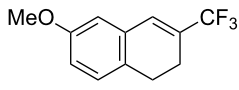
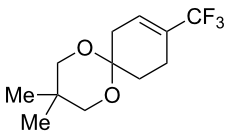
					
Compound	X =	Yield (%)	Compound	X =	Yield (%)
	OTf	83		OTf	81
	OTf	62		OTf	53
	OTf	84		OTf	75 ^a
	OTf	74 ^a		OTf	40
	OTf	36 ^a		OTf	71 ^a
	ONf	73 ^a		ONf	80 ^a
	ONf	51			

^a[(allyl)PdCl]₂ was used instead of Pd(dba)₂.

Table 5: Pd-catalyzed C–H trifluoromethylation employing Umemoto's sulfonium tetrafluoroborate salt [67].

Product	Yield (%) ^a	Product	Yield (%) ^a
	86		0 ^c
	82		88
	2-Me 84 3-Me 83 4-Me 83		75 ^c
	2-OMe 78 3-OMe 54 ^b 4-OMe 68		58 ^c
	2-Cl 55 ^c 3-Cl 75 ^c 4-Cl 72 ^c		62 ^c
	78 ^b		53 ^c
	87 ^b		74
	88		

^aYields for isolated compounds. ^b15 mol % of Pd(OAc)₂ were used. ^c20 mol % of Pd(OAc)₂ were used.

analogue. Trifluoroacetic acid and copper(II) acetate as additives proved essential for achieving high yields of the desired trifluoromethylated arenes. 2-Arylpyridines, but also other aryl-substituted heteroarenes were successfully trifluoromethylated

with complete regioselectivity in the position *ortho* to the aryl–heteroaryl bond, with moderate to high yields in most cases. Obviously, the heteroaryl group served as a directing group in this transformation. Interestingly, all isomers of

2-tolylpyridine were trifluoromethylated with highest yields; while in the case of chloro or methoxy groups, the efficiency of the reaction was dependent on the position of the substituent relative to the heteroaryl group. Notably, the chloro-substituted substrates required higher catalyst loadings for sufficient conversion. The authors also note that keto, ester and nitro substituents led to poor yields. The mechanism of this transformation and the role of the additives have not been elucidated yet.

The group of J.-Q. Yu further studied this reaction by adapting it to secondary *N*-arylbenzamides as more versatile substrates than arylpyridines [68]. In comparison with the previous reaction conditions, two equivalents of $\text{Cu}(\text{OAc})_2$ had to be used instead of one, and *N*-methylformamide as an additive appeared essential. On the other hand, the counteranion of sulfonium in Umemoto's reagent had no influence on the reaction. Various substituted arenes underwent trifluoromethylation with moderate to excellent yields (Table 6). Interestingly, bromo-, chloro- or ester-substituted substrates were also converted, allowing further derivatization. As a preliminary investigation on the mechanism of the reaction, the authors prepared an analogue of the palladacyclic intermediate supposed to be involved in the first stages of the catalytic cycle and submitted it to the reaction conditions, in the presence or not of the amide additive and of $\text{Cu}(\text{OAc})_2$ (Scheme 5). These results confirmed the indispensable involvement of these additives in the mechanism.

A complementary study by Z.-J. Shi and coworkers investigated the trifluoromethylation of acetanilides also using palladium(II) and copper(II) acetates as catalyst and additive respectively, with Umemoto's reagent [69]. Pivalic acid (vs TFA in the

case of J.-Q. Yu et al.) as an additive gave the best results. Diversely functionalized substrates were converted to the corresponding benzotrifluorides with up to 83% yield (Table 7). Striking features of the reaction were the ability to use alkoxy-carbonyl-, benzoyl, acetyl- and acetoxy-substituted acetanilides, and, above all, halogenated arenes including fluoro-, chloro-, bromo- and iodoacetanilides, rendering further functionalization possible. However, the presence of a methoxy or trifluoromethoxy group *meta* to the directing group shuts down the reaction completely. Other directing groups were investigated. When hydrogen was replaced by methyl on nitrogen in the starting acetanilide, no reaction occurred; on the other hand, *N*-pivaloyl- and *N*-benzoylanilines were trifluoromethylated, albeit with lower yields than acetanilide. From the study of kinetic isotope effects in several experiments as well as of a Pd-insertion complex similarly to the work of J.-Q. Yu et al., the authors proposed a Pd(II)/Pd(IV) catalytic cycle starting with C–H activation of the substrate followed by oxidation of the complex with Umemoto's reagent and completed by reductive elimination of the desired benzotrifluoride (Figure 2).

3.1.3 Perfluoroalkylation by means of C–H activation and a perfluoroalkyl radical-source. In contrast to the studies described above, the group of M. S. Sanford has developed a Pd-catalyzed perfluoroalkylation of arenes in the absence of directing groups [70]. Perfluoroalkyl iodides were used as the source of the fluorinated alkyl group. Under the optimized reaction conditions, a mixture of the iodide, 5 mol % Pd_2dba_3 , 20 mol % BINAP, cesium carbonate (2 equiv) and the arene (large excess) were heated under air in the absence of a cosolvent (Table 8). Benzene, naphthalene and several disubstituted benzenes were successfully transformed with 39–99% NMR yields and 27–76% isolated yields (relative to the starting per-

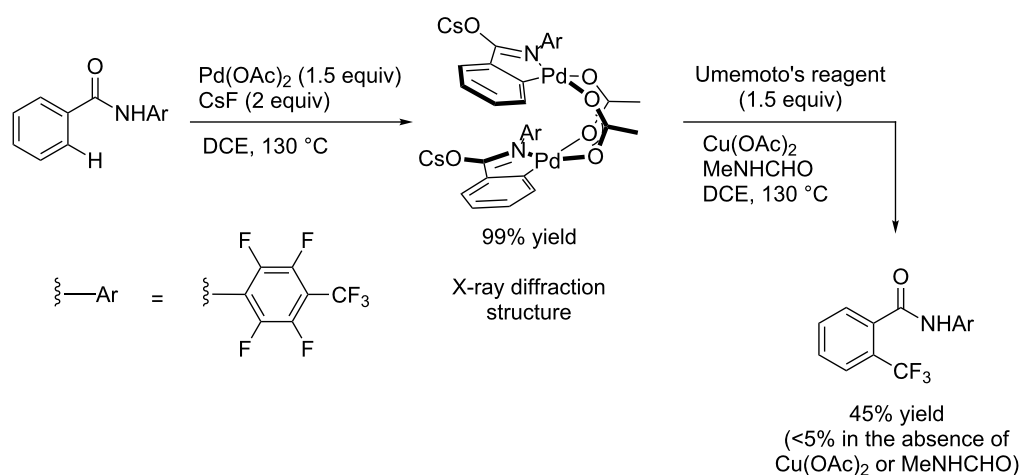

Scheme 5: Preliminary experiments for investigation of the mechanism of the C–H trifluoromethylation of *N*-arylbenzamides [68].

Table 6: Extension of Yu's C–H trifluoromethylation to *N*-arylbenzamides [68].

Product	Yield (%) ^a	Product	Yield (%) ^a
	79		77
	2-Me 84 3-Me 94 4-Me 53		55
	3-OMe 89 4-OMe 56		32 ^b
	3-F 56 4-F 61		71
	2-Cl 41 3-Cl 81 4-Cl 40		72
	82		75
	67		

^aYields for isolated compounds. ^b2 equiv of Umemoto's reagent were used for 48 h. #Indicates the initial CF₃ substituent present in the substrate.

fluoroalkyl iodide). *N*-Methylpyrrole was also perfluoroalkylated in high yield. The reaction proved very selective in several aspects, since 1,2- and 1,3-disubstituted benzenes were all preferentially functionalized at the 4-position; aryl C–H positions

were perfluoroalkylated but not benzylic positions; and only the 2-position in *N*-methylpyrrole was functionalized. A tentative mechanism was proposed, based on the literature on each of the assumed steps of the catalytic cycle (Figure 3). After oxidative

Table 7: Shi's C–H trifluoromethylation of acetanilides [69].

Product	Yield (%) ^a	Product	Yield (%) ^a
	69		R ³ = Me 64 R ³ = Et 83
	2-Me 51 3-Me 47 4-Me 63		72
	3-Ph 66 4-Ph 46		41
	F 71 Cl 72 Br 66 I 48		56
	F 52 Cl 53 Br 63		0
	0		41
	Trace		42
	77		

^aYields for isolated compounds. ^b2 equiv of Umemoto's reagent were used for 48 h. #Indicates the initial CF₃ substituent present in the substrate.

addition of the perfluoroalkyl iodide onto palladium(0), the iodide ligand is replaced by aryl by C–H activation, and a reductive elimination of the desired product liberates the palladium catalyst. Experiments carried out by the authors were inconsistent with an alternative purely free radical pathway, but could not rule out caged and/or “Pd-associated” radical intermediates.

Another study by Y. H. Budnikova et al. described the electrochemical perfluoroalkylation of 2-phenylpyridine in the presence of palladium(II) catalysts (10 mol %) and starting either from 6*H*-perfluorohexyl bromide or perfluoroheptanoic acid [71]. Interestingly, the latter reagent provided the highest yields, and the reaction appeared to proceed through an intermediate biaryl perfluoroalkylcarboxylate, which extrudes CO₂ to yield

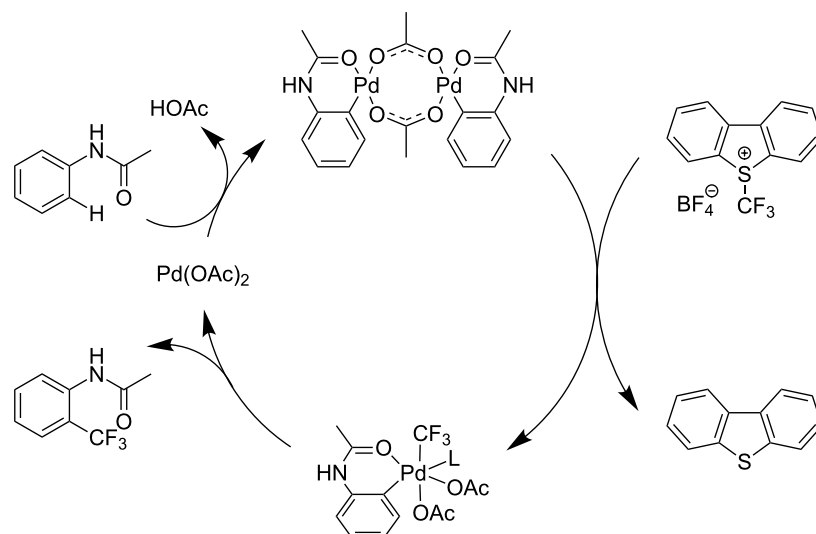
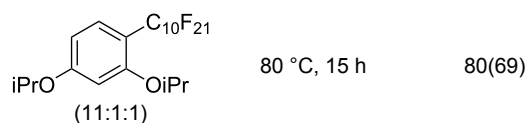
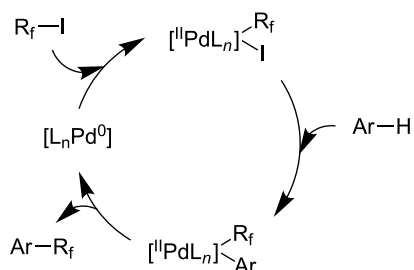

Figure 2: Plausible catalytic cycle proposed by Z.-J. Shi et al. for the trifluoromethylation of acetanilides [69].

Table 8: Sanford's Pd-catalyzed perfluoroalkylation at a C–H position of (hetero)arenes in the absence of directing groups [70].

Product (isomer ratio)	Temp., Time	NMR (and isolated) yields (%)	Product (isomer ratio)	Temp., Time	NMR (and isolated) yields (%)
(---)	100 °C, 15 h	26 ^a	(>20:1)	100 °C, 15 h	76 (54)
(---)	80 °C, 15 h	81 ^a	(2.2:1:0)	60 °C, 24 h	77 (55)
(---)	80 °C, 15 h	79 (60)	(---)	60 °C, 24 h	52 (52)
(>20:1)	80 °C, 15 h	79 (76)	(>20:1)	100 °C, 15 h	39 (27)
(17:1:2)	100 °C, 15 h	99 (69)	(4.0:1)	100 °C, 15 h	76 (34)
(---)	100 °C, 15 h	84 (59)	(>20:1)	40 °C, 15 h	99 (70)

Table 8: Sanford's Pd-catalyzed perfluoroalkylation at a C–H position of (hetero)arenes in the absence of directing groups [70]. (continued)^aGC yield (%).**Figure 3:** Plausible catalytic cycle proposed by M. S. Sanford et al. for the perfluoroalkylation of simple arenes using perfluoroalkyl iodides [70].

the desired product (Table 9). As underlined by the authors, the electrocatalytic reactions proceed under mild conditions at potentials that clearly generate high oxidation state metals.

3.1.4 Trifluoromethylation by means of presumed C–H activation and a nucleophilic CF₃-source.

A single study on palladium-catalyzed trifluoromethylation of sp²-C–H bonds was reported by G. Liu and coworkers [72]. It described the introduction of a CF₃ group at the 2-position of indoles using palladium acetate as a catalyst and the Ruppert–Prakash reagent TMSCF₃. A screening of reaction conditions showed that cesium fluoride proved the best base. PhI(OAc)₂ was the preferred oxidant over other hypervalent iodine compounds or sources of F⁺ or CF₃⁺; additionally, the presence of a bis(oxazoline) as a ligand was beneficial to the reaction, as well as that of TEMPO to prevent trifluoromethylation of the benzene ring as a side reaction. With these optimized reaction conditions, a series of indoles was successfully trifluoromethylated (Table 10). The nature of the substituent on nitrogen had a strong influence on yields. Alkyl or alkyl-derived groups as well as phenyl gave moderate to good results, but *N*-tosyl or *N*-H gave almost no desired product, if any. Indoles bearing substituents at the 2 or 3

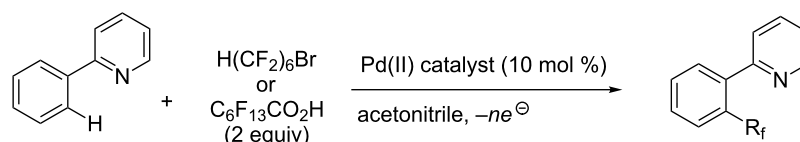
Table 9: Pd-catalyzed electrochemical perfluoroalkylation of 2-phenylpyridine [71].

Perfluoroalkyl source	Pd(II) catalyst		Yield (%)
	Pd(OAc) ₂	Pd ₂ (<i>o</i> -C ₆ H ₄ Py) ₂ (OAc) ₂	
H(CF ₂) ₆ Br			10
C ₆ F ₁₃ CO ₂ H			≤18
	+		81

Table 10: Pd-catalyzed trifluoromethylation of sp²-C–H bonds of indoles employing TMSCF₃ [72].

Product	Yield (%) ^a	Product	Yield (%) ^a
	Me	83	
	Et	72	
	Bn	62	
	<i>n</i> -Bu	63	
	Ph	50	
	SEM ^b	57	
	Ts	<5	
H	0		
	Cy	75	
	<i>c</i> -C ₅ H ₉	71	
	<i>i</i> Pr	61	
	(CH ₂) ₂ OMe	70	
	CH ₂ CH ₂ E ^c	66	
E ^c	33	60	
	Me	65	
	Ph	66	

^aIsolated yields. ^bSEM = TMS(CH₂)₂OCH₂. ^cE = CO₂Me.

positions were suitable substrates for respective 3- or 2-functionalization, although an ester group in position 3 led to a lower yield; a “naked” indole ring could be trifluoromethylated in a 39% yield. Electron-donating or -withdrawing groups on the benzo moiety were tolerated, and in particular, the presence of a halogen atom in position 5 gave yields almost as high as in the case of the unsubstituted analogue. By comparing the activities in the case of substrates bearing electron-donating and -releasing groups at the 5-position, and considering the regioselective 3-functionalization of *N*-methylindole, the authors proposed the following catalytic cycle: 1) electrophilic palladation of indole, 2) oxidation of the resulting Pd(II) species by the combination of the hypervalent iodine reagent and TMSCF₃ to give a CF₃-Pd(IV) intermediate, and 3) reductive elimination leading to the desired trifluoromethylindole.

3.2 Copper catalysis

3.2.1 Trifluoromethylation of Csp²-X bonds (X = halogen) by means of a nucleophilic CF₃-source.

In 2009, H. Amii et

al. reported on the first general copper-catalyzed trifluoromethylation of aryl iodides with TMSCF₃ in presence of potassium fluoride [33]. After activation of the fluoroalkylsilane by the fluoride, the trifluoromethyl anion is generated and leads to the formation of the CF₃Cu species. Then, σ-bond metathesis between Ar-I and CF₃-Cu yields trifluoromethylated arenes with regeneration of CuI. To perform the reaction catalytically, the use of a diamine ligand was necessary to enhance the electron density at the metal center, thus increasing the rate of σ-bond metathesis. In this way, the copper catalyst is regenerated faster and avoids in situ decomposition of the CF₃⁻ species. Heteroaromatic iodides and iodobenzenes bearing electron-withdrawing groups participated smoothly in cross-coupling reactions with good yields (Table 11).

Later, modified conditions were proposed by Z. Q. Weng et al. where *N,N*-dimethylethylenediamine (DMEDA) and AgF were used instead of 1,10-phenanthroline and KF respectively [73]. In addition to activating the silyl group of the trifluoro-

Table 11: The first Cu-catalyzed trifluoromethylation of aryl iodides [33].

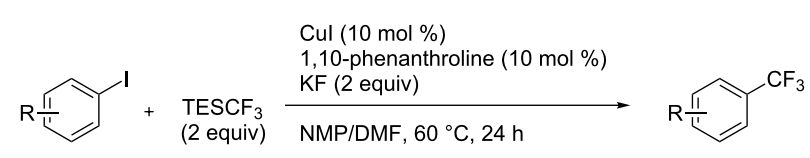
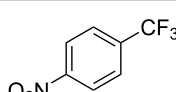
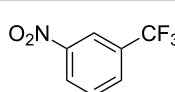
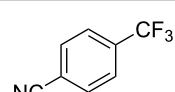
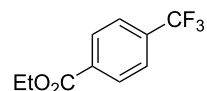
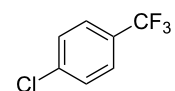
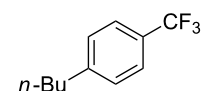
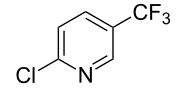
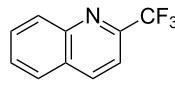
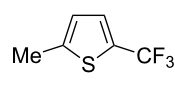
					
Compound	Yield (%) ^a	Compound	Yield (%) ^a	Compound	Yield (%) ^a
	90		90		80
	89		63		44
	69		99		63

^aNMR yield calculated by ¹⁹F NMR by using 2,2,2-trifluoroethanol as an internal standard.

methylating agent, the silver salt also acts as a stabilizer for the CF_3^- species and prevents its self-decomposition (Figure 4). As a result, the more economical TMSCF_3 can be employed, and good yields were observed for both electron-rich and electron-poor aryl iodides in this cooperative silver-assisted copper-catalyzed trifluoromethylation (Table 12).

Even if the pioneering work of H. Amii and Z. Q. Weng resulted in the development of reliable and robust catalytic systems, they suffer from the lack of accessibility to inexpensive, stable and easy-to-handle reagents that could be used as convenient CF_3^- sources for nucleophilic trifluoromethylations. The group of L. J. Goossen et al. was the first to propose a new crystalline, air-stable (trifluoromethyl)trimethoxyborate as an alternative to Ruppert's reagent [74]. This innovative reagent is readily accessible by reaction of TMSCF_3 with $\text{B}(\text{OMe})_3$ and KF in THF, and allows the conversion of a broad scope of aryl iodides in high yields without the need for basic additives (Table 13).

Hemiaminals of trifluoroacetaldehyde are also considered to be convenient sources of trifluoromethyl anion [75]. H. Amii et al. reported on the use of an *O*-silylated hemiaminal as a cross-coupling partner for aromatic trifluoromethylation with a copper iodide/1,10-phenanthroline catalytic system [76]. Compound **B** was prepared from commercially available hemiacetal of fluoral and morpholine, following the procedure described by B. R. Langlois et al. [77] Moderate to good yields were observed when the reaction was carried out in diglyme with cesium fluoride as a base (Table 14).

More recently, compounds derived from trifluoroacetic acid appeared to be a cheap and readily available nucleophilic trifluoromethyl source after decarboxylation at high temperature in the presence of stoichiometric amounts of copper salts [78,79]. In 2011, Y. M. Li et al. showed that the Cu-catalyzed C– CF_3 bond formation of iodoarenes could be achieved by using a sodium salt of trifluoroacetic acid as the source of CF_3^- [80]. Ag_2O was chosen as an additive to promote the decar-

**Figure 4:** Postulated reaction pathway for the Ag/Cu-catalyzed trifluoromethylation of aryl iodides by Z. Q. Weng et al. [73].

Table 12: Cooperative effect of silver for the copper-catalyzed trifluoromethylation of aryl iodides [73].

$\text{R-I} + \text{TMSCF}_3 \xrightarrow[\text{NMP, 90 } ^\circ\text{C, 6 h}]{\text{CuI (10 mol \%), DMEDA (20 mol \%), NaOt-Bu (20 mol \%), AgF (1.33 equiv)}} \text{R-CF}_3$					
Compound	Yield (%)	Compound	Yield (%)	Compound	Yield (%)
	75 ^b		89		98 ^b
	64		73		59
	47		66		61
	76 ^b				

^aNMR yield calculated by ¹⁹F NMR by using hexafluorobenzene as an internal standard. ^bIsolated yield.

Table 13: Cu-catalyzed trifluoromethylation of (hetero)aryl iodides with (trifluoromethyl)trimethoxyborate [74].

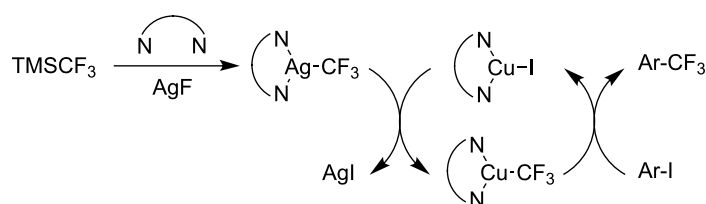
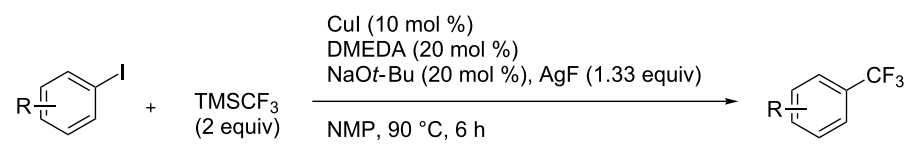
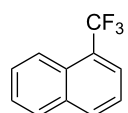
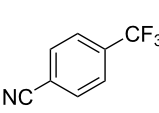
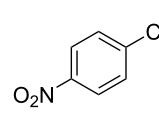
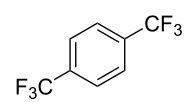
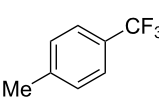
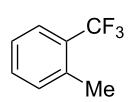
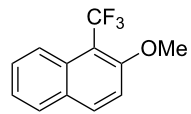
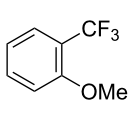
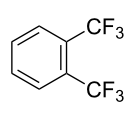
$\text{R-I} + \text{TMSCF}_3 \xrightarrow[\text{THF, rt, 24-48 h}]{\text{B(OMe)}_3, \text{KF}} \text{F}_3\text{C-B(OMe)}_3 \text{K}^+$ $\text{R-I} + \text{A (3 equiv)} \xrightarrow[\text{DMSO, 60 } ^\circ\text{C, 16 h}]{\text{CuI (20 mol \%), 1,10-phenanthroline (20 mol \%)}} \text{R-CF}_3$					
Compound	Yield (%)	Compound	Yield (%)	Compound	Yield (%)
	77		83		91
	74		92		70
	59		91		97
	81		95		76

Table 13: Cu-catalyzed trifluoromethylation of (hetero)aryl iodides with (trifluoromethyl)trimethoxyborate [74]. (continued)

	93		75		81
	82		85		84
	96		95		96
	52		84		

Table 14: Cu-catalyzed trifluoromethylation of (hetero)aryl iodides with O-silylated hemiaminal of fluoral [76].



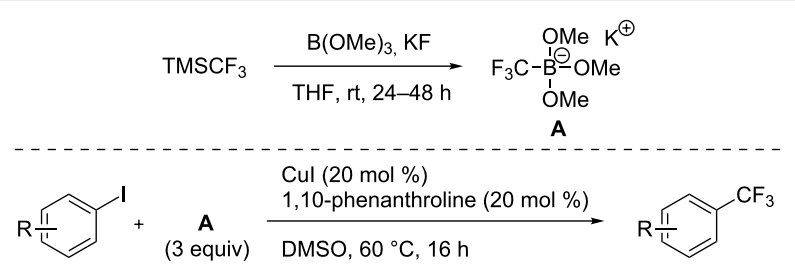
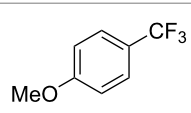
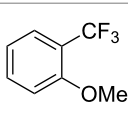
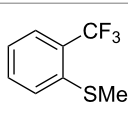
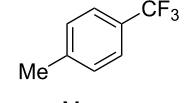
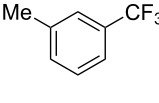
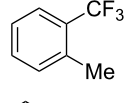
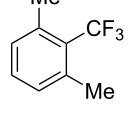
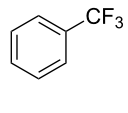
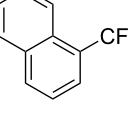
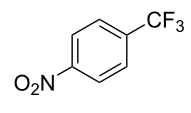
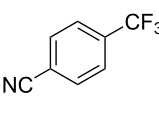

Compound	Yield (%) ^a	Compound	Yield (%) ^a	Compound	Yield (%) ^a
	77		90		47
	93		60		97
	53		53		40
	57		44		97
	95		75		

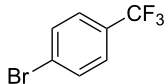
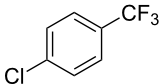
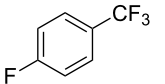
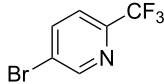
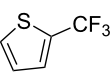
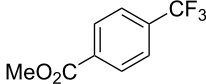
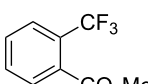
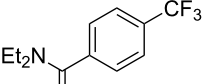
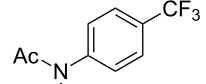
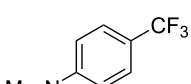
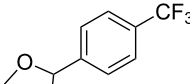
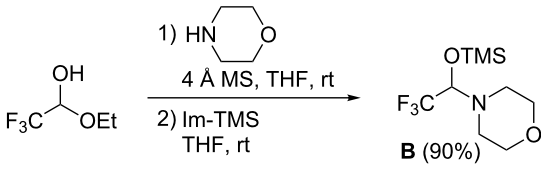
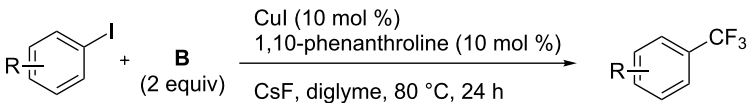
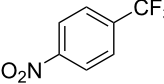
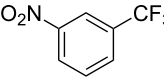
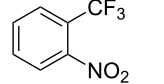
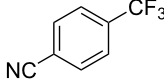
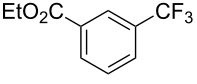
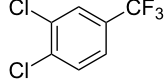
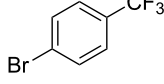
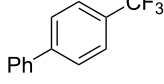
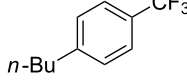
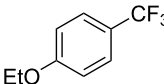
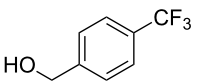
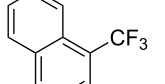
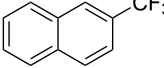
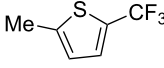
^aNMR yield calculated by ¹⁹F NMR by using trifluoromethoxybenzene as an internal standard.

boxylation, and to accelerate the reductive elimination step by precipitation of AgI. To circumvent the use of moisture-sensitive sodium trifluoroacetate, M. Beller et al. employed a combi-

nation of methyl trifluoroacetate (MTFA) and cesium fluoride to generate the trifluoroacetate anion which decarboxylated under the reaction conditions (Figure 5). In most cases, the

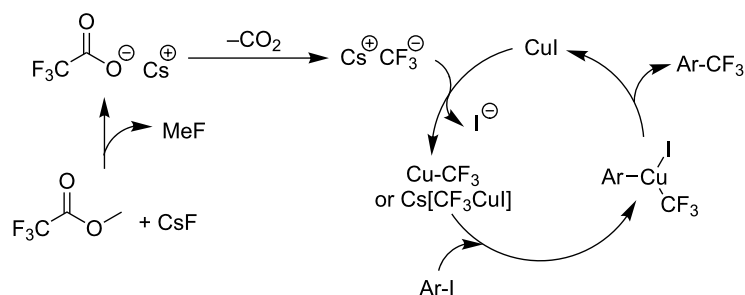

Figure 5: Postulated reaction mechanism for Cu-catalyzed trifluoromethylation reaction using MTFA as trifluoromethylating agent [81].

system does not necessitate the use of amine ligands excepted when aryl bromides are used instead of aryl iodides [81]. Aryl and heteroaryl products were formed in good to excellent yields with a good functional group tolerance (Table 15).

3.2.2 Trifluoromethylation of Csp²-H bonds by means of an electrophilic CF₃-source. In this section, the studies that are highlighted are distinguished by the nature of the substrates that are submitted to trifluoromethylation; indeed, all of them used

Table 15: Cu-catalyzed trifluoromethylation of (hetero)aryl iodides and aryl bromides with methyl trifluoroacetate [81].

$\text{R}-\text{C}_6\text{H}_4-\text{X} + \text{MTFA (4 equiv)} \xrightarrow[\text{DMF, 160 }^\circ\text{C, 16 h}]{\text{CuI (20 mol \%), CsF (1.2 equiv)}} \text{R}-\text{C}_6\text{H}_4-\text{CF}_3$					
Compound	X =	Yield (%) ^a	Compound	X =	Yield (%) ^a
	I	84		I	93
	Br	60 ^{b,c}		Br	61 ^{b,d}
	I	84		I	88
	Br	65 ^{b,d}		I	47
	Br	62 ^{b,c}		I	78
	I	84 ^{b,d}		I	69
	I	66		I	92
	I	91		I	80
	Br	50 ^b		Br	95 ^c

^aNMR yield calculated by GC using tetradecane as an internal standard, ^b20 mol % of 1,10-phenanthroline were added, ^cCsF replaced by CsTFA, ^dCsF replaced by CsCl.

the same electrophilic CF₃ source, namely Togni's benzyiodoxolone reagent.

M. Sodeoka and coworkers reported on the trifluoromethylation of indoles with Togni's hypervalent iodine reagent in the presence of catalytic copper(II) acetate [82]. No additives were necessary, and this simple procedure allowed for the functionalization of various *N*-H as well as variously *N*-protected indoles with almost complete selectivity for the 2-position, even in the case of "naked" indoles (Table 16).

The same group also reported on two examples of Heck-type copper-catalyzed trifluoromethylation of vinyl(het)arenes at the terminal carbon [83]. The reaction actually proceeded by oxytrifluoromethylation of the vinyl group, followed by elimination of the oxygen-leaving group in the presence of *p*-toluenesulfonic acid (Scheme 6).

Similarly to the Pd-catalyzed C–H trifluoromethylation of acetanilides by Z.-J. Shi et al., a copper-catalyzed process was developed by C. Chen and C. Xi and colleagues for the func-

Table 16: Sodeoka's trifluoromethylation of indoles with Togni's hypervalent iodine reagent [82].

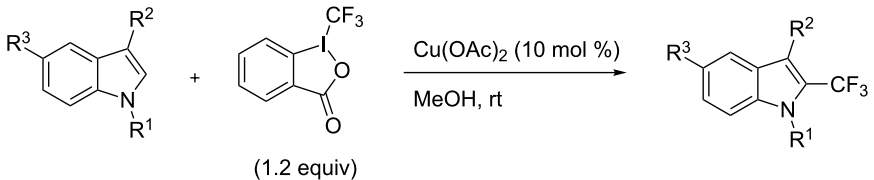
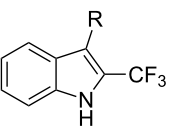
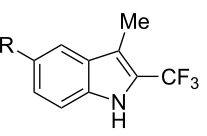
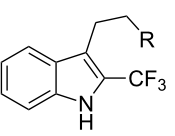
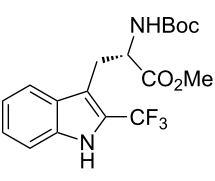
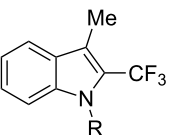
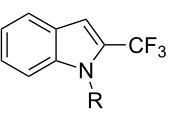
Product	Isolated yield (%) (Time)	Yield based on recovered starting material (%)
		
	Me CO ₂ Me	79 (6 h) 28 (24 h) 95 58
	OMe Br	72 (18 h) 74 (24 h) 88 90
	CO ₂ Me NHBoc NHAc	72 (24 h) 68 (24 h) 79 (24 h) 79 76 93
		48 (24 h) 86
	Me Bn Ac Boc	90 (6 h) 67 (18) 5 (24) 39 (24) 95 85 16 60
	Me Bn	58 (6 h) ^a 58 (6 h) 62 ^a 76

^aReaction carried out at 50 °C.

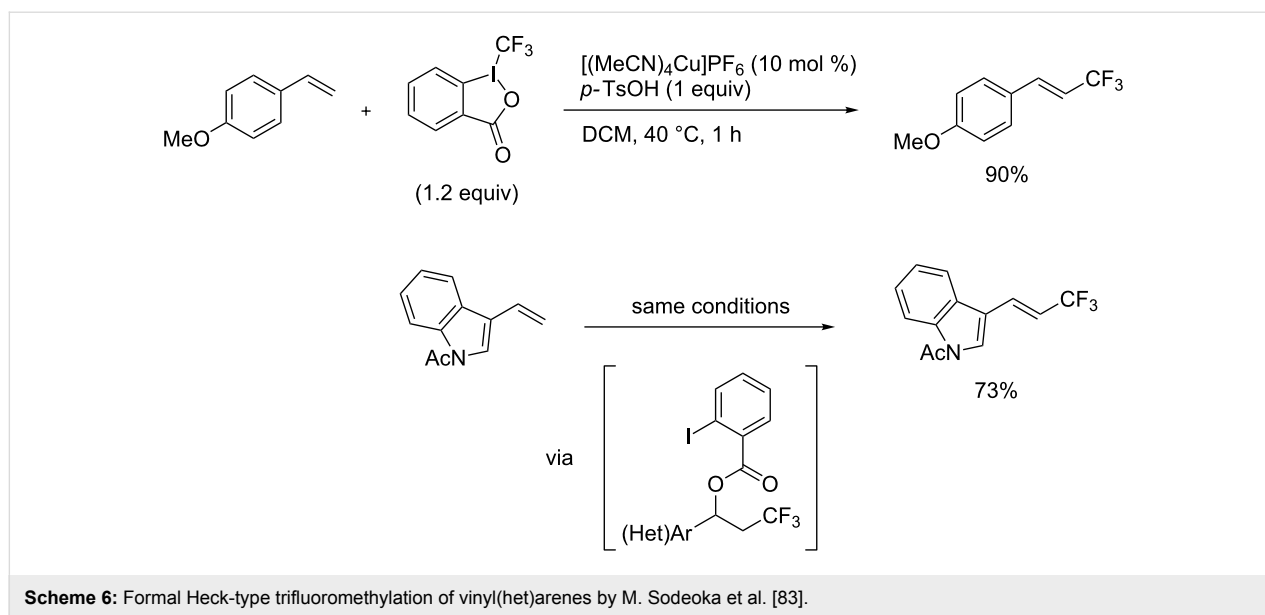

tionalization of pivanilides [84]. The latter methodology is simpler and more atom-economical since it does not require additives such as PivOH or stoichiometric metal salts as oxidants. However, it necessitates higher catalyst loadings (20 mol % CuCl vs 10 mol % Pd(OAc)₂) to ensure acceptable

yields. Various *N*-aryl and *N*-hetaryl pivalamides were successfully converted under a nitrogen atmosphere, with introduction of the CF₃ group predominantly *ortho* to the amide function (Table 17). Unlike the Pd-catalyzed reaction, this copper-catalyzed variant leads to a mixture of *ortho*-, *meta*- and *para*-

Table 17: Cu-catalyzed C–H functionalization of pivanilides [84].

Product	Temp. (°C)	Conversion (%)	Isolated yield (%) (NMR yield (%))	
	H	30	93	65 (67)
	Me	60	85	69 (70)
	iPr	90	65	55 (60)
	OMe	60	77	63 (67)
	F	90	46	42 (46)
	Cl	90	45	32 (42)
	Br	90	55	49 (53)
	CO ₂ Et ^a	120	40	30 (35)
	H ^b	45	70 ^b	40 (48) ^b
	Cl	100	67	40 (55)
	80	71	48 (57)	

Table 17: Cu-catalyzed C–H functionalization of pivalilides [84]. (continued)

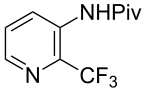
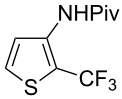
	60	60	54 (58)
	100	---	51 (---)
	100	---	86 (---)
	100	---	52 (---)

^aReaction time: 36 h. ^bThe isomer bearing CF₃ *para* to the amide group was also produced in 16% isolated yield.

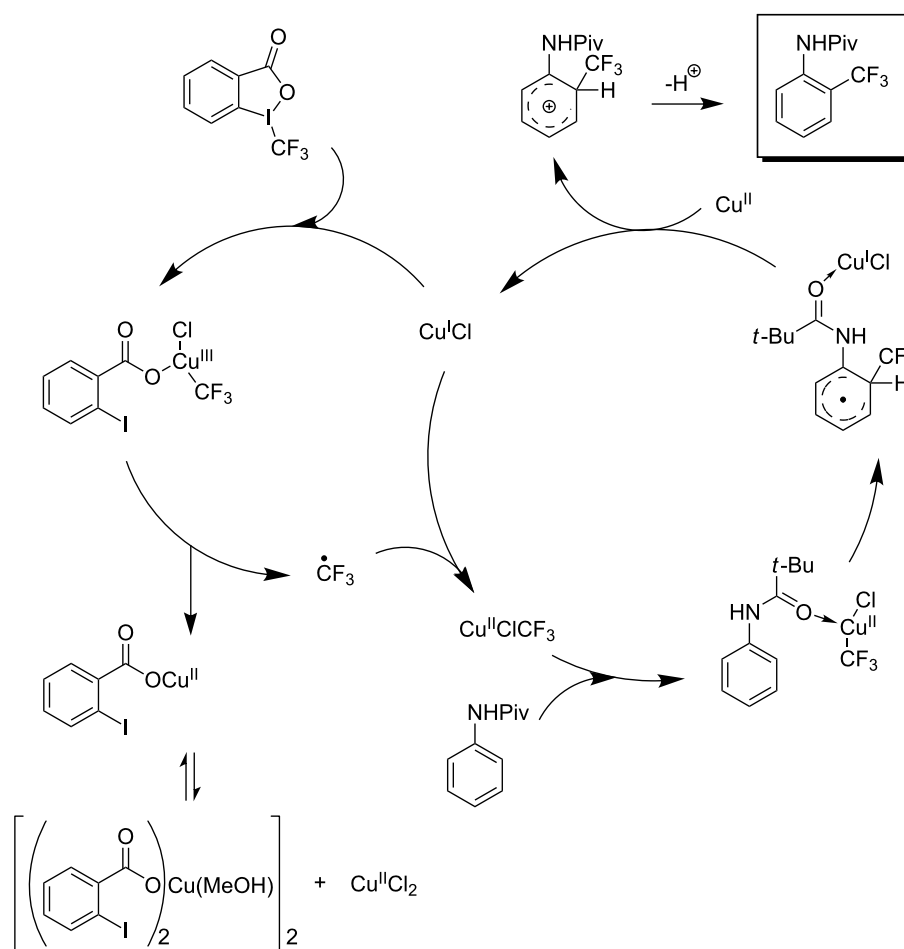

Figure 6: Proposed catalytic cycle for the copper-catalyzed trifluoromethylation of (het)arenes in presence of a pivalamido group (C. Chen, C. Xi et al.) [84].

functionalized compounds, with *ortho* > *para* > *meta* as the preferred order of selectivity in the case of simple pivalilide. Moreover, additional experiments in the presence of TEMPO or phenyl *N-tert*-butylnitron (PBN) resulted respectively in no reaction and observation of the adduct of the CF₃ radical on PBN by Electron Paramagnetic Resonance (EPR). These findings suggest a radical pathway for the mechanism of this reaction, as proposed by the authors and depicted in Figure 6.

As demonstrated recently by D. Bouyssi, O. Baudoin and coworkers, copper proved also able to catalyze the introduction of a CF₃ group at the “imino” C–H bond of *N,N*-disubstituted (het)arylhydrazones [85]. Here again, a simple system consisting of Togni’s reagent and 10 mol % of copper(I) chloride could trifluoromethylate substrates efficiently without any

additive nor heating, and in a short reaction time. The substituents on the terminal nitrogen atom had a strong influence on the reaction. Two alkyl substituents on nitrogen gave far better results than a single one; benzyl as well as phenyl groups were tolerated, although giving lower yields. A broad substitution pattern on the (hetero)aryl ring was compatible with the reaction, and the “imino” C–H was selectively trifluoromethylated (Table 18). When carrying out the reaction in the presence of TEMPO, the desired reaction was almost completely shut down, while a nearly quantitative ¹⁹F NMR yield was determined for the formation of the TEMPO-CF₃ adduct, giving evidence for a radical mechanism (Figure 7).

Very recently, K. J. Szabó et al. [86] and Y. Zhang and J. Wang et al. [87] simultaneously published their work on the trifluoromethylation of variously functionalized quinones. Both groups

Table 18: Baudoin’s Cu-catalyzed trifluoromethylation of *N,N*-disubstituted (het)arylhydrazones [85].

			
Product	Yield (%) ^a	Product	Yield (%) ^a
	NMe ₂ 96 NBn ₂ 61 NPh ₂ 30 NHMe --- ^b 1-piperidinyl 88 4-morpholinyl 86		82
	CN 99 F 56 ^c OH 65 ^d NMe ₂ 56		85
	73		85
	82		74

Table 18: Baudoin's Cu-catalyzed trifluoromethylation of *N,N*-disubstituted (het)arylhydrazones [85]. (continued)

	90		75
	80		60 ^e
	68 ^d		

^aYields for isolated compounds. ^bComplex crude mixture. ^cVolatile compound (78% NMR yield). ^dCuI was used as catalyst in DCM. ^e18 h reaction time; additional CuCl (10 mol %) and Togni's reagent (0.5 equiv) were added after 15 h (68% conversion) to complete the reaction.

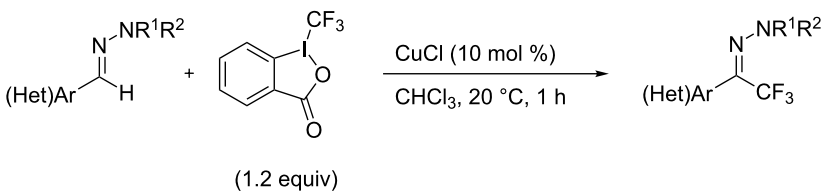
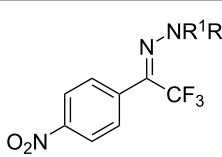
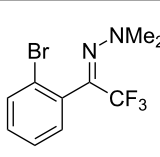
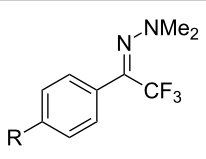
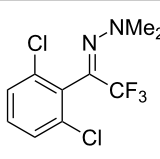
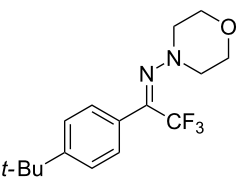
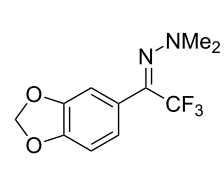
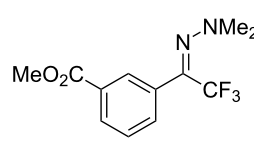
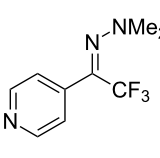
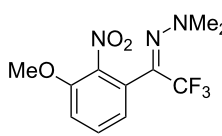
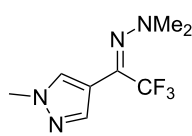
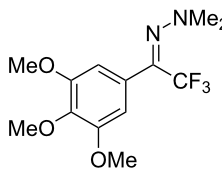
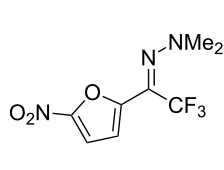
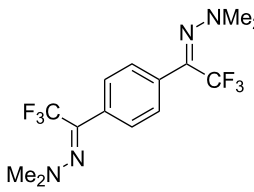
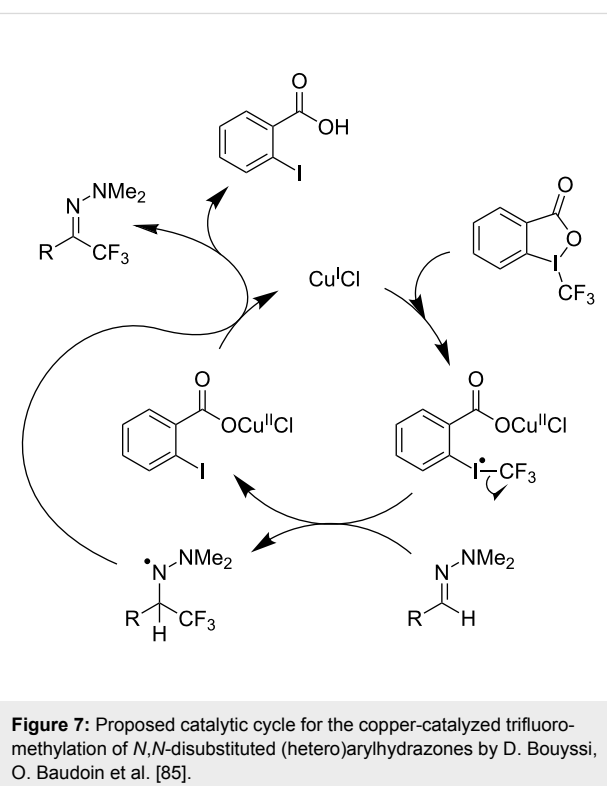

observed the inefficiency of Umemoto's sulfonium reagents in this reaction, whereas Togni's benziodoxolone reagent gave the best results. Y. Zhang, J. Wang and coworkers used 20 mol %

of copper(I) iodide in a 1:1 *t*-BuOH/DCM solvent system at 55 °C with 2 equivalents of Togni's reagent [87]. On the other hand, K. J Szabó et al. had to use stoichiometric amounts of copper(I) cyanide and catalytic bis(pinacolato)diboron to achieve optimal yields, but a catalytic amount of CuCN could also produce the desired trifluoromethylated products if stoichiometric potassium or tetrabutylammonium cyanide were also added to the reaction medium [86]. Both groups noticed that in the presence of TEMPO as radical scavenger, the reaction was seriously inhibited, and TEMPO-CF₃ was obtained in high yields. Y. Zhang and J. Wang et al. proposed a plausible mechanism to account for this observation [87]. The mechanism is related to those described above for pivanilides (C. Chen, C. Xi et al.) or hydrazones (D. Bouyssi, O. Baudoin et al.) (Figure 8).

3.2.3 Perfluoroalkylation of Csp²-H bonds by means of a CF₃-radical source. Clearly Togni's electrophilic reagent is able to generate the CF₃[•] radical in the presence of catalytic copper(I) sources. However, generation of this radical and its use in copper-catalyzed trifluoromethylation of sp²-C-H bonds was described much earlier by B. R. Langlois et al. [88]. In their report, *N*-acetylpyrrole and a series of electron-rich benzenes were functionalized in moderate yields by using sodium trifluoromethanesulfonate (Langlois's reagent) and *tert*-butyl peroxide with 10 mol % of copper(II) triflate (Table 19). The supposed mechanism implies single electron transfers where *t*-BuOOH and Cu(OTf)₂ serve as oxidants (Figure 9).

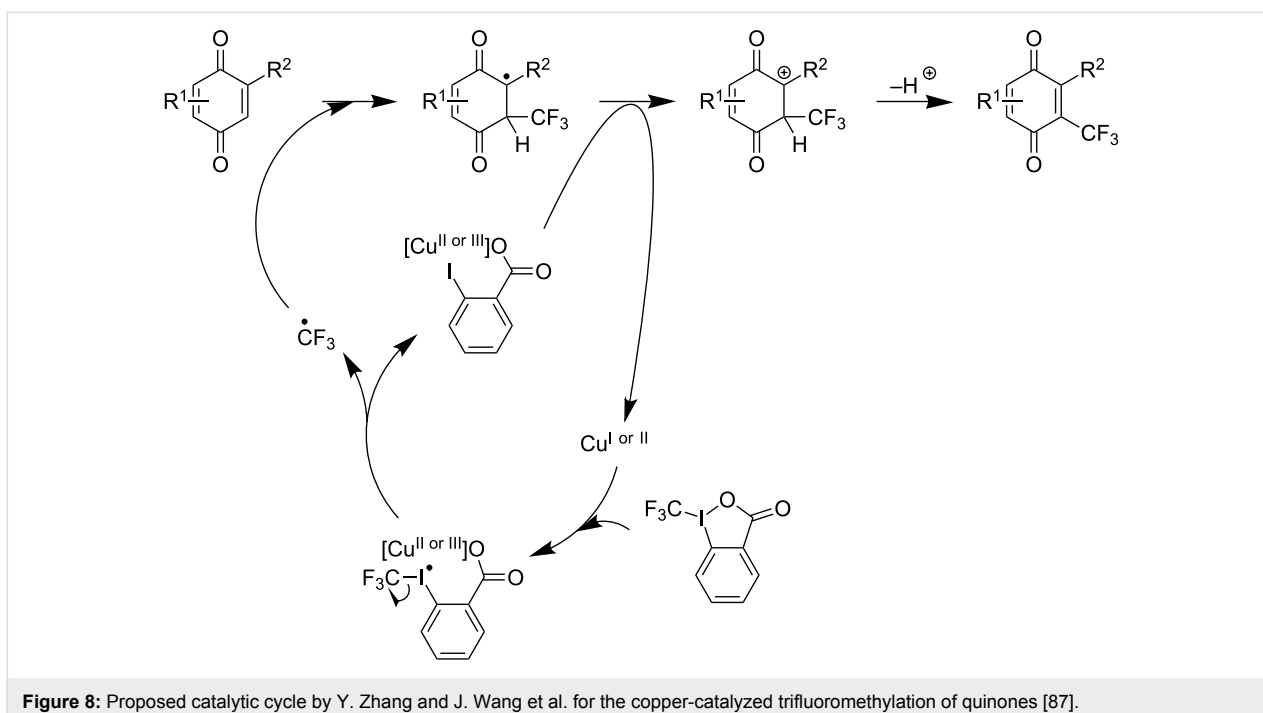

Interestingly, Langlois's reagent was also used recently by P. S. Baran et al. for the generation of the CF_3^\bullet radical and trifluoromethylation of heteroaromatic compounds [89]. Although

copper(II) sulfate (10 mol %) led to improved yields, trifluoromethylation was found to proceed in the absence of added metallic catalysts, and it is believed that traces only of metals

Table 19: Cu-catalyzed trifluoromethylation with Langlois's sodium trifluoromethanesulfinate as CF_3 radical source [88].

Product	$\text{CH}_3\text{CN}/\text{H}_2\text{O}$ ratio	Isolated Yield (%)	Product ratio
	1:0	45	<i>o/m/p</i> = 4:1:6
	1:0	21	---
	1:2	13	n.p. (2 isomers)

Table 19: Cu-catalyzed trifluoromethylation with Langlois's sodium trifluoromethanesulfinate as CF₃ radical source [88]. (continued)

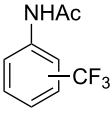
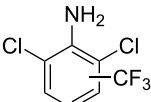
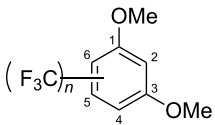
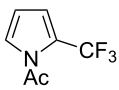
	1:2	52	<i>o/m/p</i> = 4:1:2
	1:0	29	4-CF ₃ /3-CF ₃ = 3:1
	1:0	90 ^a	2-CF ₃ /6-CF ₃ /2,6-(CF ₃) ₂ /4,6-(CF ₃) ₂ = 23:58:4:2.5
	n.p.	35	---

^aReaction carried out under N₂. n.p. = not precized by the authors.

present in the CF₃ source are sufficient to initiate the reaction (Scheme 7).

Finally, F. Minisci et al. showed that catalytic amounts of Cu(II) salts could improve the yields in the perfluoroalkylation of arenes by perfluoroalkyl iodides in the presence of benzoyl peroxide (Scheme 8). The copper salts are believed to speed up the process by superimposing a redox chain to the radical chain [90].

3.2.4 Trifluoromethylation of Csp²-H bonds by means of a nucleophilic CF₃-source. To the best of our knowledge, there is only one report in the literature by L. Chu and F.-L. Qing, where catalytic copper was used in the trifluoromethylation of sp²-C-H bonds by a nucleophilic CF₃-releasing reagent [91]. In this paper, heteroarenes or arenes bearing acidic sp²-C-H bonds were trifluoromethylated by the Ruppert–Prakash reagent in presence of catalytic copper(II), a base and an oxidant. The reaction conditions had to be slightly customized for each class

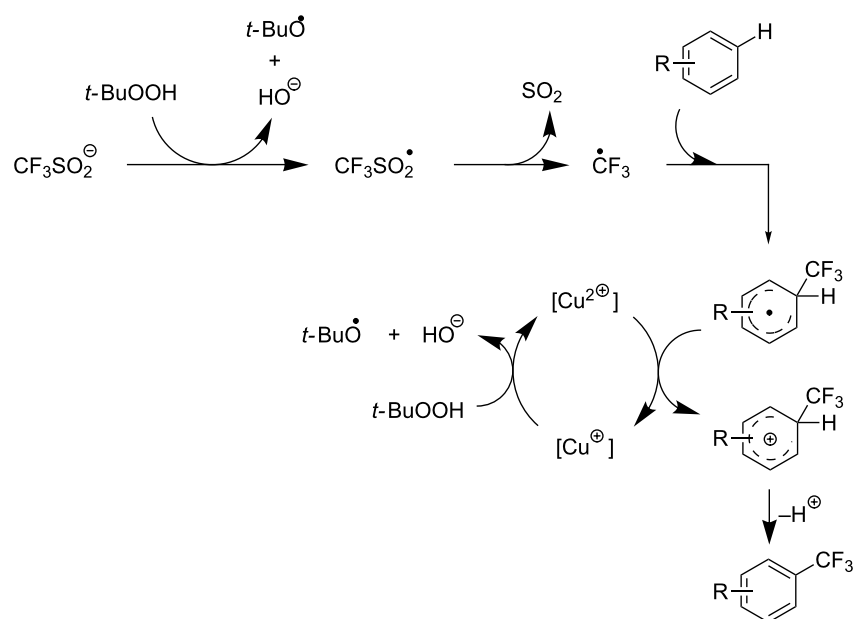
**Figure 9:** Mechanistic rationale for the trifluoromethylation of arenes in presence of Langlois's reagent and a copper catalyst (B. R. Langlois et al.) [88].

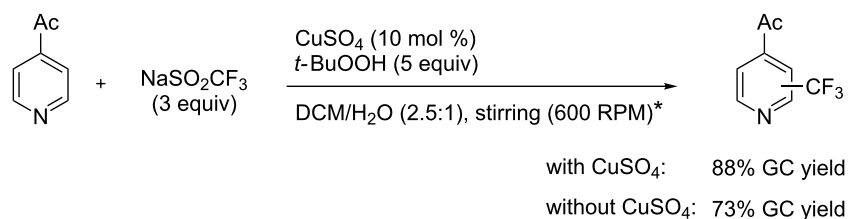

Scheme 7: Trifluoromethylation of 4-acetylpyridine with Langlois's reagent by P. S. Baran et al. (* Stiring had a strong influence on the reaction efficiency; see the original article for details) [89].

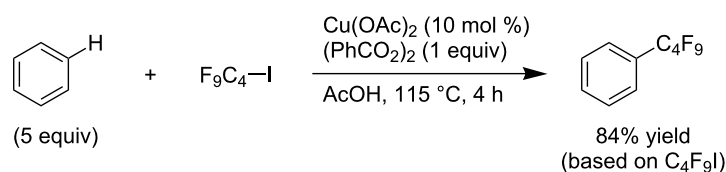

Proposed mechanism

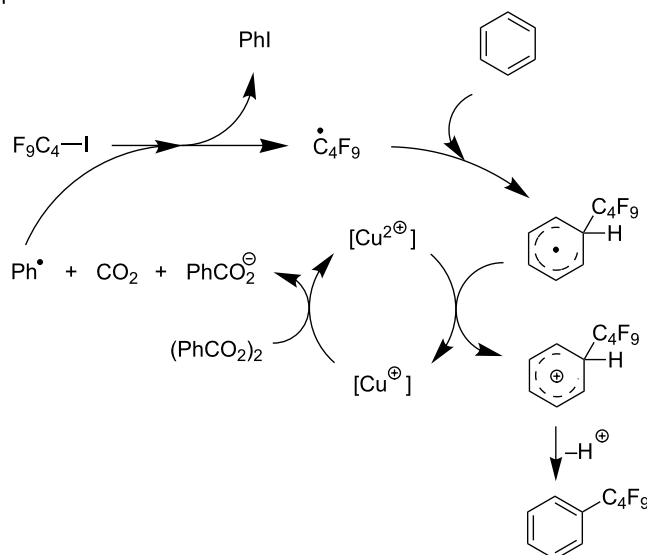

Scheme 8: Catalytic copper-facilitated perfluorobutylation of benzene with C₄F₉I and benzoyl peroxide [90].

of substrates. The methodology was first developed for 2-substituted 1,3,4-oxadiazoles (Cu(OAc)₂/1,10-phenanthroline/*t*-BuONa/NaOAc/air, Table 20), then extended to benzo[*d*]oxazoles, benzo[*d*]imidazoles, benzo[*d*]thiazoles, imidazoles and polyfluorobenzenes (same system but di-*tert*-butyl peroxide as oxidant instead of air, Table 21); the nature of the copper(II) salt, the base and the oxidant had to be reassessed for the reaction of indoles (Cu(OH)₂/1,10-phenanthroline/KF/Ag₂CO₃). Interestingly, the results obtained for indoles could be directly compared to those reported by G. Liu and coworkers for the analogous, Pd-catalyzed, TMSCF₃-induced trifluoromethylation of the same substrates (section 3.1.4). It appears that the Cu-based system gave generally higher yields. L. Chu

and F.-L. Qing compared stoichiometric and catalytic experiments and came to the conclusion that the reaction most probably proceeded via a trifluoromethylcopper(I) species, which would activate the C–H bond of the substrate and then be oxidized to a copper(III) complex, finally releasing the trifluoromethylated product by reductive elimination (Figure 10).

3.2.5 Trifluoromethylation of arylboron reagents with a nucleophilic CF₃-source under oxidative conditions. F.-L. Qing reported on the first Cu-catalyzed cross-coupling of aryl- and alkenylboronic acids with TMSCF₃ under oxidative conditions (Table 22) [34,92]. Although the detailed mechanism remains to be elucidated, the authors presume that the reaction

Table 20: Qing's Cu-catalyzed trifluoromethylation of 1,3,4-oxadiazoles with the Ruppert–Prakash reagent [91].

		
Product	Isolated Yield (%)	
	H Me <i>t</i> -Bu OMe CF ₃ NO ₂ CO ₂ Me Cl	89 83 91 87 72 43 81 83
		85

Table 21: Extension of Qing's Cu-catalyzed trifluoromethylation to benzo[*d*]oxazoles, benzo[*d*]imidazoles, benzo[*d*]thiazoles, imidazoles and polyfluorobenzenes [91].

					
Product	Yield (%) ^a	Product	Yield (%) ^a		
	Me Ph Br Cl		88 (95 ^b) 58 75	30 ^b	
	Me (CH ₂) ₂ CH=CH ₂		57 ^b 32 ^b	H OMe CF ₃	81 83 69
			74 ^b	F 4-MeO-C ₆ H ₄	93 ^c 63 ^b

^aIsolated yields, unless otherwise noted. ^bSome starting material was also recovered. ^c¹⁹F NMR yield using an internal standard.

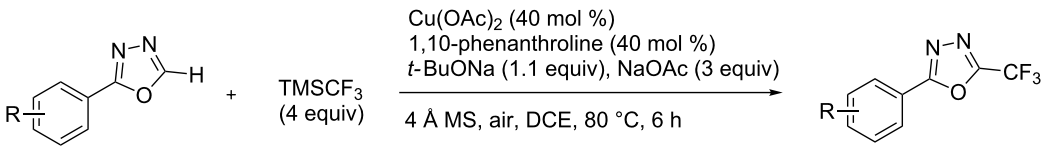
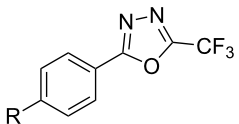
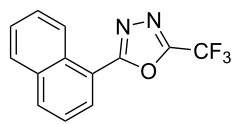
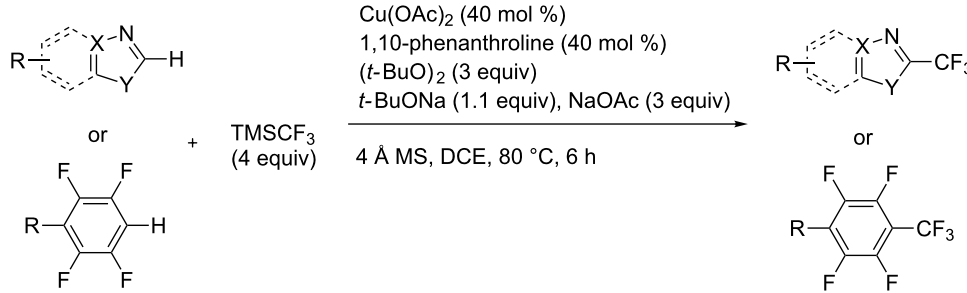
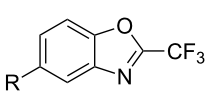
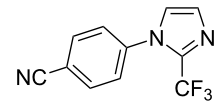
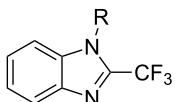
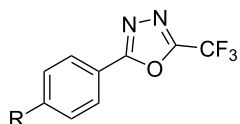
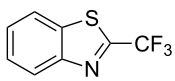
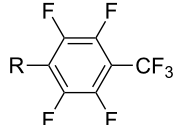
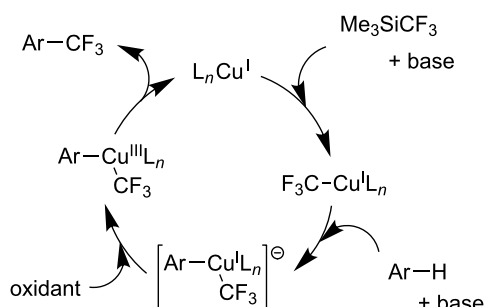

Figure 10: F.-L. Qing et al.'s proposed mechanism for the copper-catalyzed trifluoromethylation of (hetero)arenes with the Ruppert–Prakash reagent [91].

proceeds via generation of CuCF_3 followed by transmetalation with the arylboronic acid. The diamine stabilizes the CuCF_3 species. This facilitates the oxidation to Cu(II) or Cu(III) species which undergo facile reductive elimination.

3.2.6 Trifluoromethylation of arylboron reagents with an electrophilic CF_3 -source. L. Liu found that the copper-catalyzed trifluoromethylation of aryl, heteroaryl, and vinylboronic acids with Umemoto's trifluoromethyl dibenzosulfonium salt can be performed under mild conditions and with tolerance towards a variety of functional groups (Table 23) [93].

Q. Shen reported on the copper-catalyzed trifluoromethylation of aryl- and alkenylboronic acids employing Togni's hypervalent iodine reagent. The reaction proceeds in good to excellent yields affording a wide range of trifluoromethylated products (Table 24) [94].

A similar approach has been reported by K.-W. Huang and Z. Weng employing organotrifluoroborates under base free conditions (Table 25) [95].

3.2.7 Radical trifluoromethylation of arylboron reagents. In contrast to previous approaches where relatively expensive trifluoromethylsilanes are required such as Ruppert–Prakash reagent (TMSCF_3) or TESCF_3 to generate a CF_3 -nucleophile, and *S*-(trifluoromethyl)thiophenium salts or Togni's reagent to generate a CF_3^+ -electrophile, an alternative approach has recently been reported, by different groups, where highly reactive CF_3 radicals are generated.

M. S. Sanford has developed a mild and general approach for the Cu-catalyzed/Ru-photocatalyzed trifluoromethylation and perfluoroalkylation of arylboronic acids [96]. The ruthenium-bipyridyl complex plays a double role in this reaction, namely the generation of the CF_3 radical, and the oxidation of Cu(I) to Cu(II) under photoexcitation. Both products then combine to afford a Cu(III)CF_3 species, which undergoes transmetalation with the arylboronic acid. Finally, reductive elimination from

Table 22: Cu-catalyzed cross-coupling of (hetero)aryl- and alkenylboronic acids with TMSCF_3 under oxidative conditions [92].

$(\text{Het})\text{Ar}-\text{B}(\text{OH})_2 + \text{TMSCF}_3$		$(\text{Het})\text{Ar}-\text{CF}_3$	
		(CuOTf) ₂ ·C ₆ H ₆ (10 mol %) 1,10-phenanthroline (20 mol %) Ag ₂ CO ₃ (1 equiv) KF, K ₃ PO ₄ , DMF, 45–70 °C	
Compound	Yield (%)	Compound	Yield (%)
	58		81
	74		65
	78		49
	72		56

Table 23: Cu-catalyzed trifluoromethylation of aryl, heteroaryl, and vinyl boronic acids with Umemoto's trifluoromethyl dibenzosulfonium salt [93].

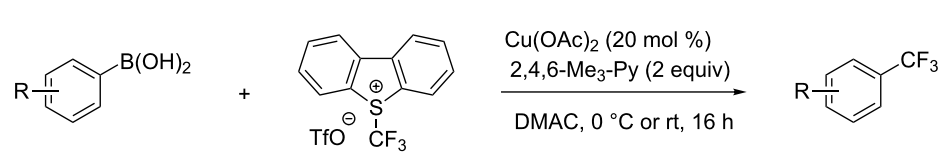

Compound	Yield (%)	Compound	Yield (%)	Compound	Yield (%)
	70		39		65
	60		30		65
	57		52		57
	70		78		50
	40		59		62
	64		54		51
	65		46		

Table 24: Cu-catalyzed trifluoromethylation of aryl- and alkenylboronic acids employing Togni's hypervalent iodine reagent [94].



Compound	Yield (%)	Compound	Yield (%)	Compound	Yield (%)
	80		53		90

Table 24: Cu-catalyzed trifluoromethylation of aryl- and alkenylboronic acids employing Togni's hypervalent iodine reagent [94]. (continued)

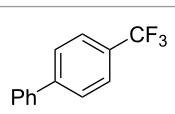
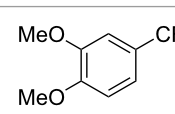
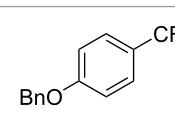
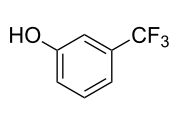
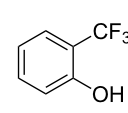
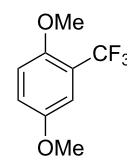
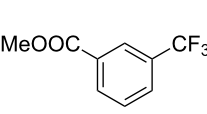
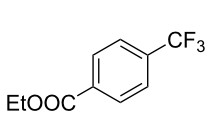
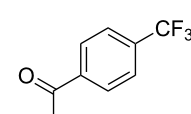
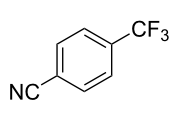
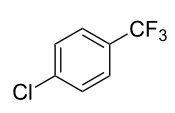
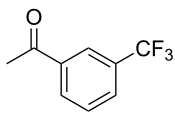
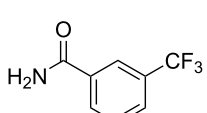
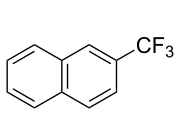
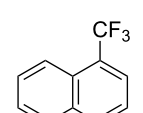
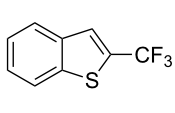
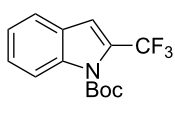
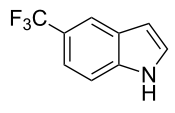
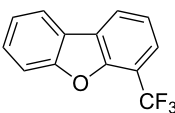
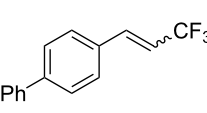
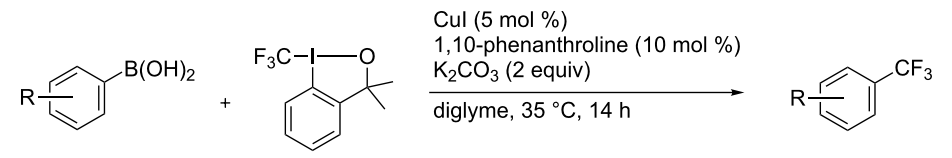
	85		90		90
	90		95		90
	70		85		50
	75		55		70
	76		73		80

Table 25: Cu-catalyzed trifluoromethylation of organotrifluoroborates with Togni's hypervalent iodine reagent [95].

Compound	Yield (%)	Compound	Yield (%)	Compound	Yield (%)
	95		91		60
	92		89		94
	69		50		39
	42		72		82
	65		81		65
	51		50		70

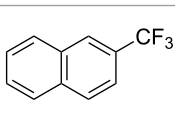
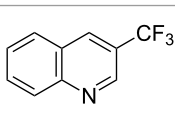
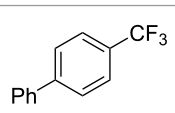
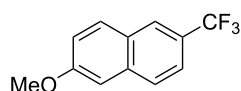
Table 25: Cu-catalyzed trifluoromethylation of organotrifluoroborates with Togni's hypervalent iodine reagent [95]. (continued)

65

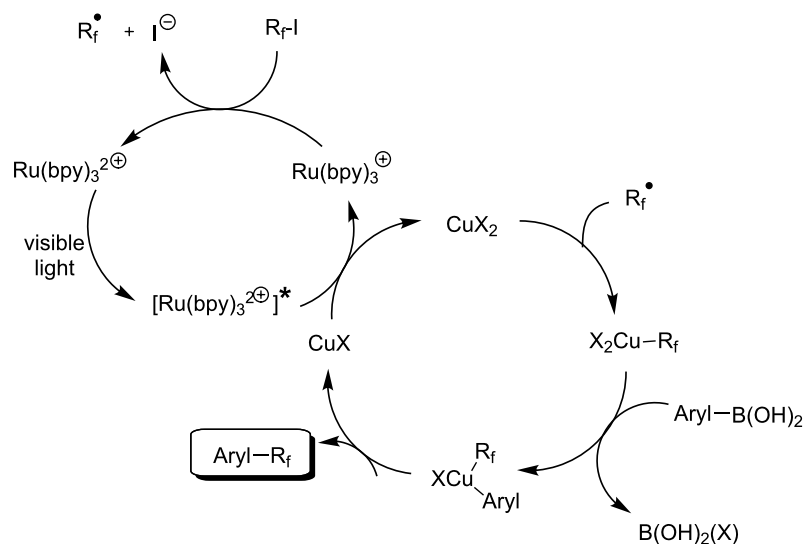
**Figure 11:** Mechanism of the Cu-catalyzed/Ru-photocatalyzed trifluoromethylation and perfluoroalkylation of arylboronic acids [96].

Cu(III)(aryl)(CF₃) affords the desired aryl-CF₃ product (Figure 11 and Table 26).

M. Beller et al. investigated the copper-catalyzed trifluoromethylation of aryl and vinyl boronic acids with in situ gener-

ated CF₃-radicals using NaSO₂CF₃ (Table 27 and Table 28) [97]. The CF₃ radical is generated from the reaction of TBHP (*t*-BuOOH) with NaSO₂CF₃. Transmetalation of the arylboronic acid with the Cu(II) species gives an aryl copper(II) complex. Combination of the CF₃ radical with this complex

Table 26: Sanford's Cu-catalyzed/Ru-photocatalyzed trifluoromethylation and perfluoroalkylation of (hetero)arylboronic acids [96].

(Het)Ar-B(OH) ₂ + CF ₃ -I		CuOAc (20 mol %) Ru(bpy) ₃ Cl ₂ ·6H ₂ O (1 mol %) K ₂ CO ₃ (1 equiv)		(Het)Ar-CF ₃	
		26 W light bulb, DMF, 60 °C, 12 h			
Compound	Yield (%)	Compound	Yield (%)	Compound	Yield (%)
	70		70		84
	72		64		65
	64		93		42

Table 26: Sanford's Cu-catalyzed/Ru-photocatalyzed trifluoromethylation and perfluoroalkylation of (hetero)arylboronic acids [96]. (continued)

	39		64		63
	68		68		64
	64		66		67
	48		56		54
	80				

Table 27: Cu-catalyzed trifluoromethylation of (hetero)arylboronic acids [97].

<p style="text-align: center;"> </p>					
Compound	Yield (%)	Compound	Yield (%)	Compound	Yield (%)
	74		66		61
	73		69		47
	39		68		53
	60		57		58
	58		41		39
	63		34		

Table 28: Cu-catalyzed trifluoromethylation of vinylboronic acids [97].

$\text{Ar}-\text{CH}=\text{CH}-\text{B}(\text{OH})_2 + \text{CF}_3\text{SO}_2\text{Na} \xrightarrow[\text{CH}_2\text{Cl}_2, \text{H}_2\text{O}, \text{rt, air, 6 h}]{\text{Cu}(\text{OAc})_2 (20 \text{ mol } \%), \text{imidazole} (24 \text{ mol } \%), \text{TBHP} (16.1 \text{ equiv}), 2,4,6\text{-collidine} (2 \text{ equiv}), \text{NH}_4\text{Cl} (2.5 \text{ equiv})} \text{Ar}-\text{CH}=\text{CH}-\text{CF}_3$					
Compound	Yield (%)	Compound	Yield (%)	Compound	Yield (%)
	60		65		67
	56		70		70
	66				

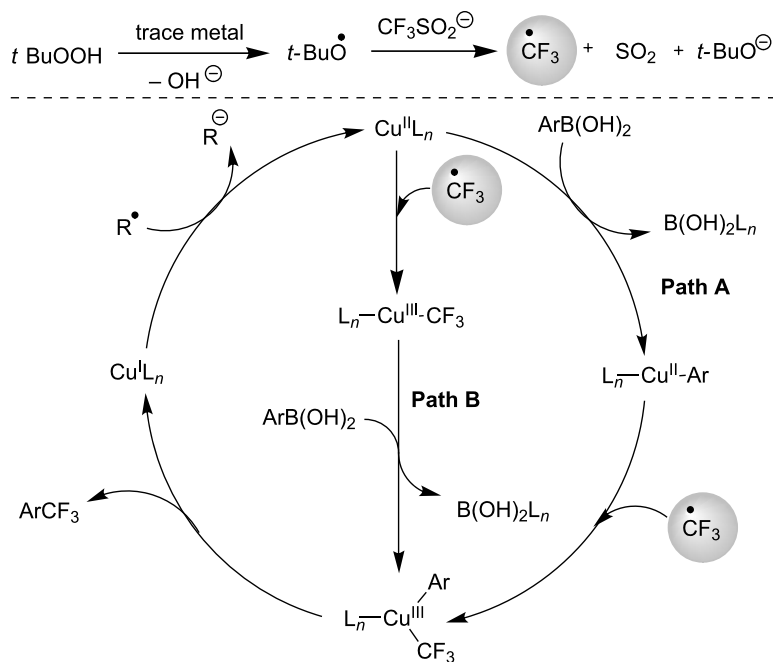
**Figure 12:** Proposed mechanism for the Cu-catalyzed trifluoromethylation of aryl- and vinyl boronic acids with NaSO_2CF_3 [97].

affords the arylcopper(III) CF_3 intermediate (Figure 12, Path A). Reductive elimination then gives the trifluoromethylated product and a Cu(I) complex which is re-oxidized to the active Cu(II) catalyst. The authors postulate also a second mechanism in which CF_3 radicals react with the Cu(II) catalyst to give the aryl copper(III) complex. This is followed by transmetalation with the aryl- or vinylboronic acid affording the same intermediate proposed in Path A (Figure 12, Path B).

3.2.8 Trifluoromethylation of α,β -unsaturated carboxylic acids. Carboxylic acids have often been reported as convenient reactants for metal-catalyzed decarboxylative cross-coupling reactions. The methodology developed by J. Hu et al. for the difluoromethylation of α,β -unsaturated carboxylic acids (section 2.1) has also been applied for the introduction of a CF_3 moiety [61]. Togni's reagent was used as the electrophilic source of CF_3 and reacted with 4 equivalents of the (*E*)-vinylcarboxylic

acid in the presence of a Lewis acid catalyst ($\text{CuF}_2 \cdot 2\text{H}_2\text{O}$). Moderate to good yields were obtained for the transformation, but a slight erosion of the configuration of the double bond was observed in some cases (Table 29). The choice of the electrophilic trifluoromethylating agent seems to be crucial as no reaction was observed with Umemoto's reagent.

Recently, Z.-Q. Liu et al. reported on a direct formation of C–CF₃ bonds by using Langlois's reagent as a stable and inexpensive electrophilic trifluoromethyl radical source to access trifluoromethyl-substituted alkenes [62]. Cinnamic acids were

reacted with sodium trifluoromethanesulfinate and a catalytic amount of copper(II) sulfate in the presence of *tert*-butyl hydroperoxide (TBHP) as the radical initiator. The reaction was achieved with α,β -unsaturated carboxylic acids bearing electron-donating groups, as well as with heteroarene substituted acrylic acids, and the desired products were isolated in modest to good yields (Table 30). Steric effects do not appear to have an influence on the outcome of the reaction.

The radical CF_3^{\cdot} is generated by the reaction of TBHP with NaSO_2CF_3 and the catalytic source of Cu(II). The Cu(I)

Table 29: Cu-catalyzed C–CF₃ bond formation on α,β -unsaturated carboxylic acids through decarboxylative fluoroalkylation [61].

$\text{R}^1\text{CH}=\text{C}(\text{R}^2)\text{COOH} + \text{F}_3\text{C-I-O-CO-C}_6\text{H}_4\text{CO} \xrightarrow[\text{H}_2\text{O/dioxane, 80 }^\circ\text{C, 12 h}]{\text{CuF}_2 \cdot 2\text{H}_2\text{O (20 mol \%)}} \text{R}^1\text{CH}=\text{C}(\text{R}^2)\text{CF}_3$					
(4 equiv)		(1 equiv)			
Compound	Yield (%)	Compound	Yield (%)	Compound	Yield (%)
	42		74		66
	60		70		60
	62		52		44
	60		52		

Table 30: Cu-catalyzed decarboxylative trifluoromethylation of α,β -unsaturated carboxylic acids with sodium trifluoromethanesulfinate [62].

$\text{R}^1\text{CH}=\text{C}(\text{R}^2)\text{COOH} + \text{NaSO}_2\text{CF}_3 \xrightarrow[\text{CH}_2\text{Cl}_2/\text{H}_2\text{O, 50 }^\circ\text{C, 5-36 h}]{\text{CuSO}_4 \cdot 5\text{H}_2\text{O (10 mol \%), TBHP (5 equiv)}} \text{R}^1\text{CH}=\text{C}(\text{R}^2)\text{CF}_3$					
Compound	Yield (%)	Compound	Yield (%)	Compound	Yield (%)
	80		78		59

Table 30: Cu-catalyzed decarboxylative trifluoromethylation of α,β -unsaturated carboxylic acids with sodium trifluoromethanesulfinate [62]. (continued)

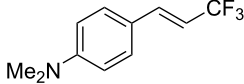
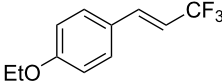
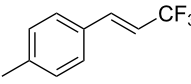
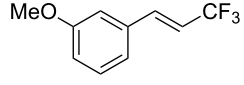
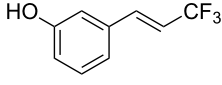
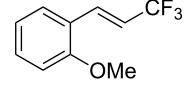
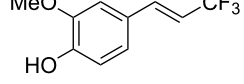
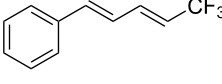
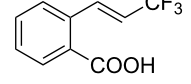
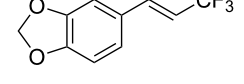
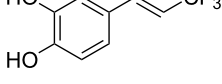
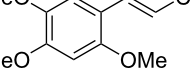
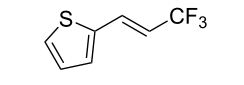
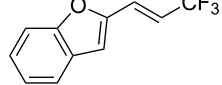
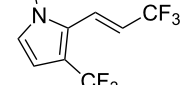
	79		60		56
	52		64		65
	82		48		68
	72		78		80
	42		46		42

reduced from the former step reacts with the cinnamic acid in the presence of TBHP to afford a cupric cinnamate, which then undergoes the addition of the trifluoromethyl radical to the double bond. The CF_3 -substituted alkene is finally obtained after elimination of carbon dioxide and Cu(I) (Figure 13).

3.3 Catalysis by other metals than Pd and Cu

3.3.1 Ru-catalyzed perfluoroalkylation of $\text{Csp}^2\text{-H}$ bonds.

More than two decades ago, the group of N. Kamigata pursued extensive investigations on the perfluoroalkylation of alkenes, aromatics and heteroaromatics catalyzed by $\text{Ru(II)Cl}_2(\text{PPh}_3)_3$

[98-104]. In the course of their initial studies [98,100] aimed at the perfluoroalkylchlorination of terminal alkenes, they noticed that the corresponding 1-perfluoroalkyl-substituted alkenes were sometimes obtained along with the desired addition products (Scheme 9).

Afterwards, N. Kamigata et al. applied this system to arenes [99] and heteroarenes (furans, pyrroles and thiophenes) [102-104] and gave a full account of this work (Scheme 9) [101]. Monosubstituted benzenes gave mixtures of the *ortho*-, *meta*- and *para*-isomers. The reaction was much more regioselective

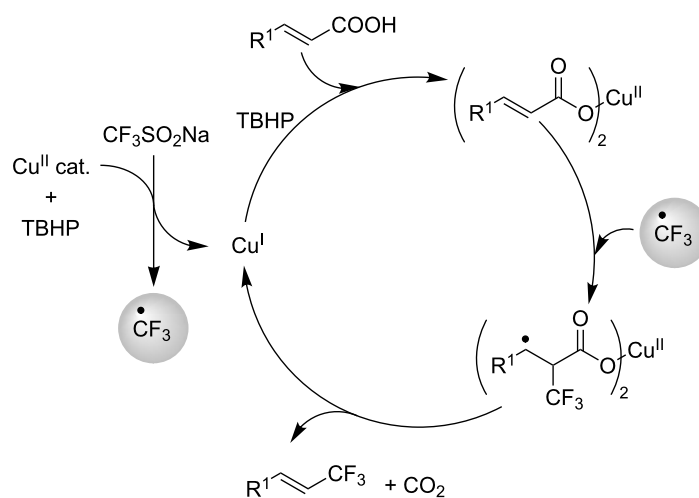
**Figure 13:** Possible mechanism for the Cu-catalyzed decarboxylative trifluoromethylation of cinnamic acids [62].

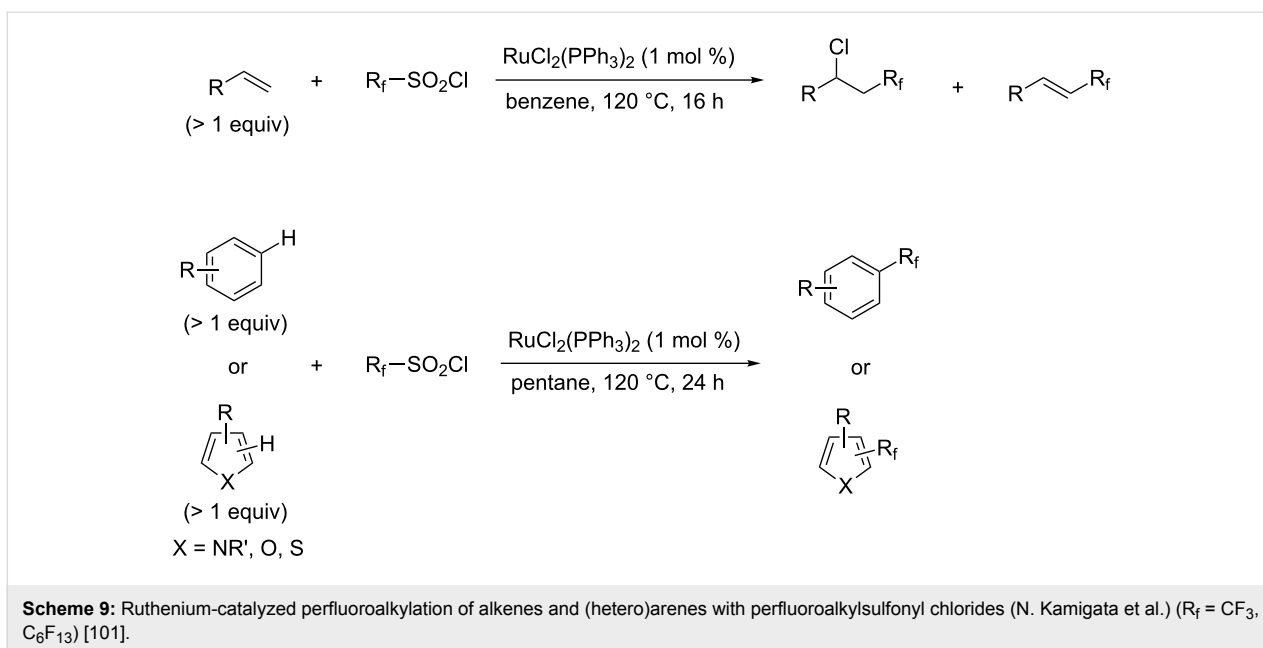

in the case of thiophenes, where 2-perfluoroalkylated products were obtained, as long as at least one of the positions α to sulfur was unsubstituted; otherwise β -functionalization occurred. The same comment is applicable to pyrroles bearing a small group on nitrogen, which gave the 2-perfluoroalkylated compound as the major product. For instance, *N*-TMS-pyrrole afforded a global yield of 78% of the 2-functionalized product as a mixture of the silylated and hydrolyzed compounds. On the other hand, the reaction of *N*-triisopropylsilylpyrrole favoured the 3-perfluoroalkylated product over its 2-isomer, due to the steric bulk of the TIPS group. Considering the mechanism of these reactions, the authors propose a radical pathway, and more

specifically a pathway where the radicals “lie in the coordination sphere of the metal”. Indeed, the present radicals led to less side-reactions – in particular, oligomerization in the case of alkenes as substrates –, which shows that they exhibit “restricted reactivity” in comparison with “that of free radicals initiated by peroxides or diazo compounds and by photoirradiation” (Figure 14) [100].

Much later, another Ru-catalysis-based methodology for the introduction of CF_3 groups at C–H positions of arenes and heteroarenes was developed by D. W. C. MacMillan [105]. Again, trifluoromethanesulfonyl chloride was used as the CF_3

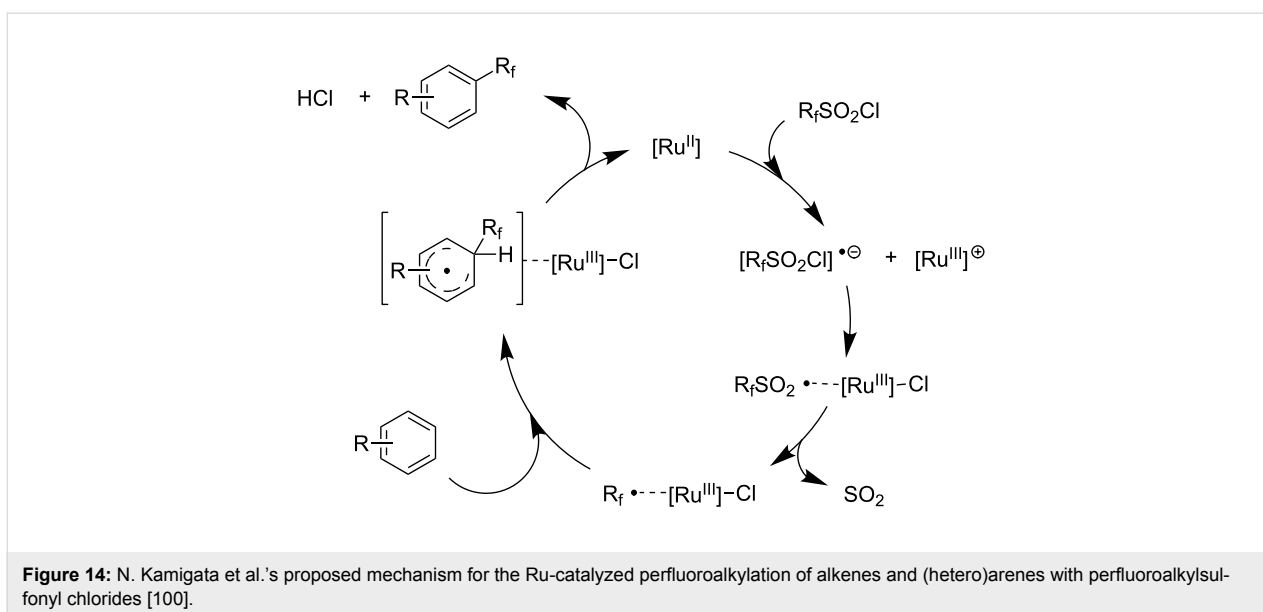

radical source. The difference with the work of N. Kamigata et al. is that the reaction takes place under photoredox catalysis, allowing much milder reaction conditions (23 °C for D. W. C. MacMillan et al. vs 120 °C for N. Kamigata et al.). Higher yields were obtained, especially in the case of pyrroles (2-R_f-

pyrrole: 88% yield for D. W. C. MacMillan et al. (CF₃) vs 0% for N. Kamigata et al. (C₆F₁₃); 2-R_f-N-Me-pyrrole: 94% yield (CF₃) vs 18% (C₆F₁₃)). A wide range of substrates was functionalized (Table 31). Interestingly, the late-stage trifluoromethylation of pharmaceutically relevant molecules was also

Table 31: Ru-catalyzed photoredox trifluoromethylation of (hetero)arenes with trifluoromethanesulfonyl chloride [105].

(Het)Ar-H + CF ₃ SO ₂ Cl (1–4 equiv)		RuCl ₂ (phen) ₃ (1–2 mol %)		(Het)Ar-CF ₃	
		26 W light source K ₂ HPO ₄ , MeCN, rt			
Product ^a		Yield (%) ^b (isomer ratio)	Product ^a		Yield (%) ^b (isomer ratio)
	R ¹ ,R ² = H R ¹ ,R ² = Me,H R ¹ ,R ² = Boc,H R ¹ ,R ² = H,CF ₃	88 94 78 91		H Me	87 80
	5-Me 3-Me	82 76 (3:1) ^c			70
		84		R = H; 2-CF ₃ R = Ac; 3-CF ₃	72 (4:1) ^d 81 (3:1) ^e
	R ¹ ,R ² ,R ³ = Me,H,Me R ¹ ,R ² ,R ³ = Me ₃ R ¹ ,R ² ,R ³ = H,H,OMe R ¹ ,R ² ,R ³ = H,Me,OMe	73 81 78 (3:1) ^f 78		R ¹ ,R ² ,R ³ = H,H,OMe R ¹ ,R ² ,R ³ = Me,H,Me R ¹ ,R ² ,R ³ = H,Me,Me R ¹ ,R ² ,R ³ = H,Cl,Cl	82 78 94 70
	R ¹ ,R ² ,R ³ = iPr,Me,OH R ¹ ,R ² ,R ³ = SMe,Me,H R ¹ ,R ² ,R ³ = (OMe) ₃	85 72 86			74
		87			90
		88			
	H NHBoc OMe SMe	74 80 (3:1) ^g 84 (2:1) ^g 73 (2:1) ^g		R ¹ ,R ² = H,Me R ¹ ,R ² = Br,H R ¹ ,R ² = H,H	70 75 (4:1) 77 (2:1) ^h

Table 31: Ru-catalyzed photoredox trifluoromethylation of (hetero)arenes with trifluoromethanesulfonyl chloride [105]. (continued)

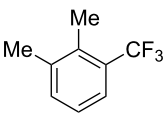
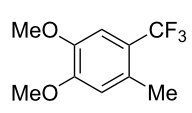
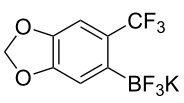
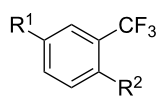
	72 (2:1)		92 (5:1) ⁱ
	74 (2:1) ^j		R ¹ ,R ² = Me ₂ 77 R ¹ ,R ² = (OMe) ₂ 85 R ¹ ,R ² = TMS,OMe 76 R ¹ ,R ² = Me,OMe 85 (4:1) R ¹ ,R ² = <i>t</i> -Bu,Me 78 (5:1)

^aThe major isomer is represented. ^bIsolated yields of the mixtures of isomers, except for volatile compounds (¹⁹F NMR yields). ^cMinor isomer: 3-Me-5-CF₃-thiophene. ^dMinor isomer: 3-CF₃-indole. ^eMinor isomer: *N*-acetyl-2-CF₃-indole. ^fMinor isomer: 2-OMe-5-CF₃-pyridine. ^gMinor isomer: *para*-substituted product. ^hMinor isomer: 1,3-Me₂-2-CF₃-benzene. ⁱMinor isomer: 1,2-(OMe)₂-5-Me-3-CF₃-benzene. ^jMinor isomer: 4,6-disubstituted isomer.

carried out and proved successful (Figure 16). The mechanism of the reaction was similar to that proposed by N. Kamigata et al. (Figure 15).

A complementary study was published by E. J. Cho et al. in 2012 [106]. Here, terminal and internal alkene C–H bonds were trifluoromethylated under photoredox Ru-catalysis, using trifluoromethyl iodide instead of trifluoromethanesulfonyl chloride (Table 32). Interestingly, arenes were unreactive under the reaction conditions. The catalyst loading was very low (0.1 mol %) and the reactions proceeded at room temperature, giving generally high yields of the trifluoromethylalkenes. Two equivalents of DBU as an additive were optimal, since this reagent is assumed to behave both as a reductant and as a base in the proposed mechanism of the reaction. Thus, the Ru(I)/Ru(II) catalytic cycle is different from the mechanism proposed by D. W. C. MacMillan and coworkers (Ru(II)/Ru(III) cycle, Figure 17).

The same group also applied this methodology to the trifluoromethylation of indoles and a couple of other heteroarenes, under closely related conditions. Trifluoromethyl iodide, catalytic Ru(II)(bpy)₃Cl₂ and TMEDA, as the base, were used with acetonitrile as the solvent (Table 33). Electron-deficient heteroarenes and unactivated arenes were unreactive. The mechanism is analogous to the one depicted for alkenes [106].

Last but not least, a completely different strategy used by S. Blechert et al. involved the cross-metathesis of terminal olefins with perfluoroalkylethylenes [108]. Thus, the reaction does not proceed through the direct introduction of C_nF_{2n+1}⁺, C_nF_{2n+1}[•] or C_nF_{2n+1}[−], but of a perfluoroalkylmethylene (Scheme 10).

3.3.2 Ir-catalyzed perfluoroalkylation of Csp²–H bonds. As a preamble, it should be noted that D. W. C. MacMillan and E. J. Cho tested iridium complexes along with the ruthenium

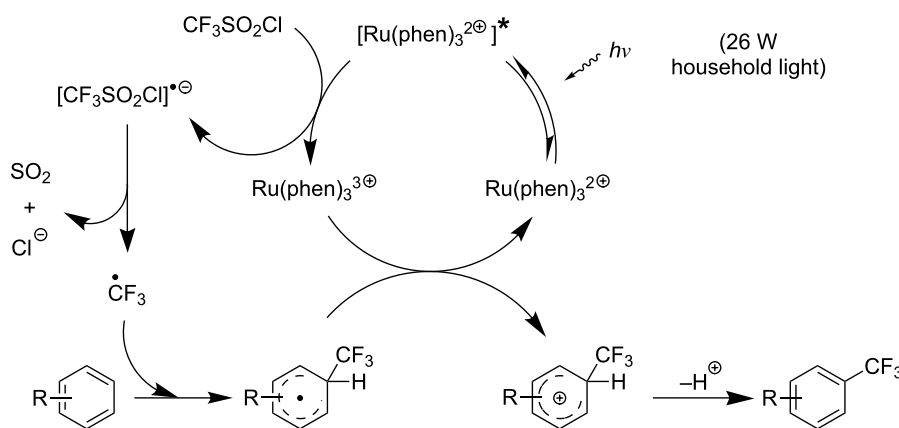
**Figure 15:** Proposed mechanism for the Ru-catalyzed photoredox trifluoromethylation of (hetero)arenes with trifluoromethanesulfonyl chloride [105].

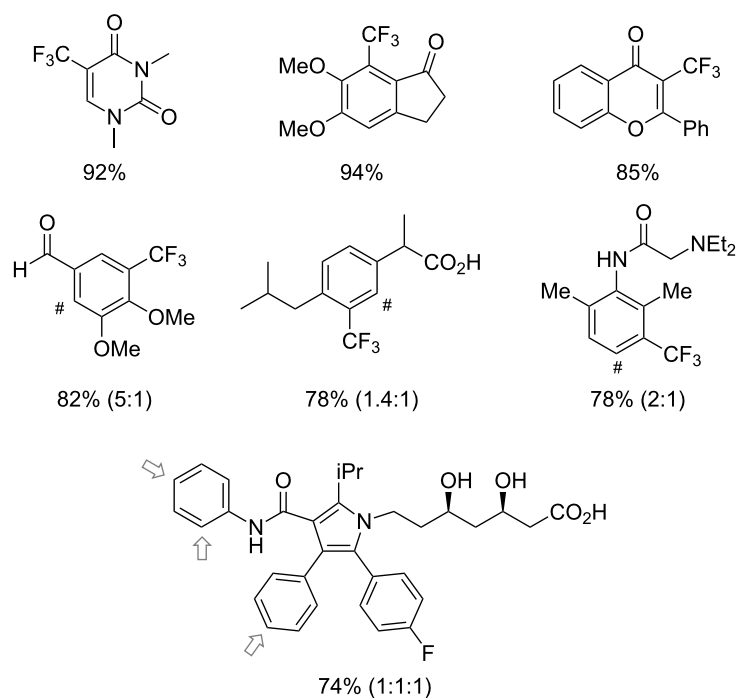

Figure 16: Late-stage trifluoromethylation of pharmaceutically relevant molecules with trifluoromethanesulfonyl chloride by photoredox Ru-catalysis (D. W. C. MacMillan et al.) (The position of the CF₃ group in the other isomers produced is marked with # or an arrow) [105].

analogues in the photoredox catalytic reactions discussed in section 3.3.1. Although also active, the iridium catalysts showed lower selectivity and are more expensive [105–107].

A different strategy was simultaneously reported by the groups of J. F. Hartwig and Q. Shen [35,37]. The approach consists of a one-pot, two-stage reaction, with Ir-catalyzed borylation of an

Table 32: Photoredox Ru-catalyzed trifluoromethylation of terminal and internal alkene C–H bonds with trifluoromethyl iodide [106].

$\text{R}-\text{CH}=\text{CH}-\text{H} + \text{CF}_3\text{-I} \xrightarrow[\text{CH}_3\text{CN} [0.5 \text{ M}], \text{rt}]{\text{RuCl}_2(\text{phen})_3 (0.1 \text{ mol } \%), \text{DBU} (2 \text{ equiv}), 14 \text{ W light source}}$			
Product	Yield (%) ^a	Product	Yield (%) ^a
$n\text{-C}_{10}\text{H}_{21}-\text{CH}=\text{CH}-\text{CF}_3$	95	$\text{Ph}-\text{CH}_2-\text{CH}_2-\text{CH}=\text{CH}-\text{CF}_3$	90
$\text{RO}-\text{CH}_2-\text{CH}_2-\text{CH}=\text{CH}-\text{CF}_3$	H 80 C(O)- <i>n</i> -hept 80 Bz 93 C(O)NMe ₂ 80 TBDMS 89 Ts 90	 + 36%	51
$\text{R}-\text{C}(=\text{O})-\text{CH}_2-\text{CH}_2-\text{CH}=\text{CH}-\text{CF}_3$	H 78 Me 81	$n\text{-C}_4\text{H}_9-\text{CH}=\text{CH}-\text{CF}_3$	80 ^b

Table 32: Photoredox Ru-catalyzed trifluoromethylation of terminal and internal alkene C–H bonds with trifluoromethyl iodide [106]. (continued)

	<i>n</i> -hept	85		55 ^c
	4-Br-C ₆ H ₄	83		
	4-Cl-C ₆ H ₄	79		
				84 ^d

^aIsolated yields, unless otherwise noted. ^bDiastereomer ratio 1.4:1. ^c¹⁹F NMR yield. ^d17:1 ratio with the allyl-CF₃ isomer.

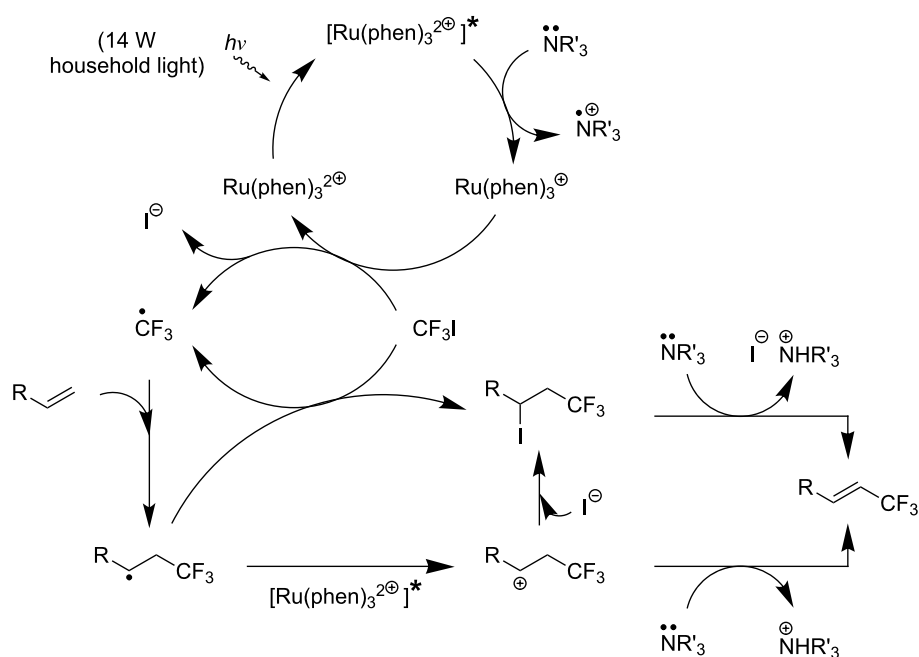
**Figure 17:** Proposed mechanism for the trifluoromethylation of alkenes with trifluoromethyl iodide under Ru-based photoredox catalysis (E. J. Cho et al.) [106].**Table 33:** Trifluoromethylation of indoles with trifluoromethyl iodide under Ru-based photoredox catalysis [107].

Product	Yield (%) ^a	Product	Yield (%) ^a
	90		95 ^d
	94		71

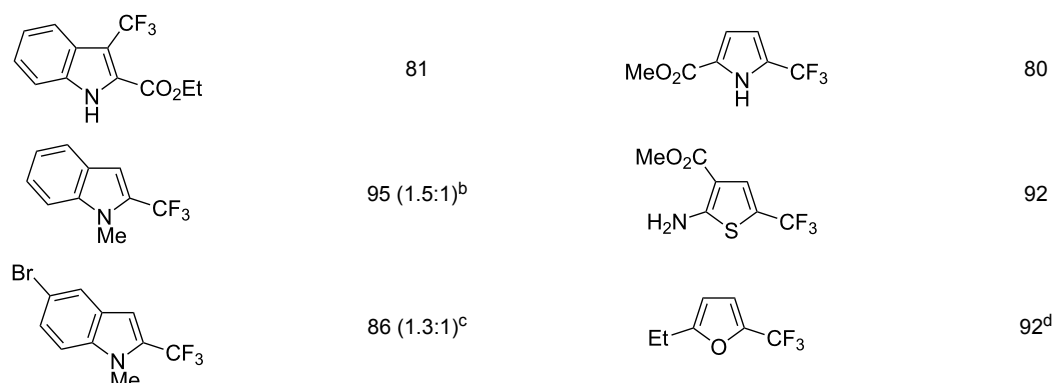
Table 33: Trifluoromethylation of indoles with trifluoromethyl iodide under Ru-based photoredox catalysis [107]. (continued)

^aIsolated yields unless otherwise noted. ^bAs a 1.5:1 mixture with the 3-CF₃ isomer; the major isomer is represented. ^cAs a 1.3:1 mixture with the 2-CF₃ isomer; the major isomer is represented. ^d¹⁹F NMR yield.

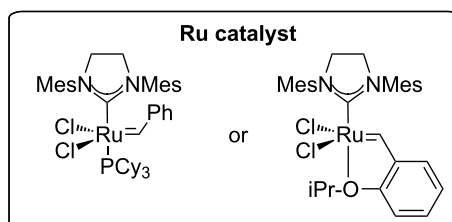
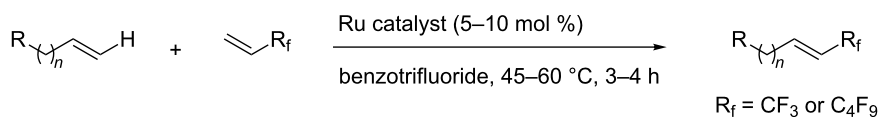
**Scheme 10:** Formal perfluoroalkylation of terminal alkenes by Ru-catalyzed cross-metathesis with perfluoroalkylethylenes (S. Blechert et al.) [108].

aromatic sp²-C–H bond, followed by a copper-mediated or -catalyzed perfluoroalkylation of the resulting arylboronic ester intermediate. Since the work by J. F. Hartwig et al. uses stoichiometric amounts of ex situ-prepared Cu-R_f reagents, we will focus on the study by Q. Shen et al. – although, once again, both are closely related. In the latter, catalytic copper(II) thiophene carboxylate was used in the second stage in the presence of 1,10-phenanthroline as a ligand; Togni's reagent served as the CF₃-source (Table 34). The interest of this reaction resides in the fact that the Ir-catalyzed borylation with bis(pinacolato)diboron is highly influenced by the steric bulk of the arene, and therefore leads to regioselective functionalization of the substrate. Arenes and heteroarenes, variously substituted, could undergo the reaction, including natural product related or complex small molecules (Figure 18) [37].

3.3.3 Ni-catalyzed perfluoroalkylation of Csp²-H bonds.

Two early reports by Y.-Z. Huang et al. described Ni-catalyzed

perfluoroalkylation of anilines, benzene, furan, thiophene and pyrrole using ω-chloroperfluoroalkyl iodides [109,110]. Notably, the reaction was rather selective: only *ortho*- or *para*-functionalized anilines were obtained (the ratio of which depended on the solvent), and 5-membered heterocycles all yielded the α-perfluoroalkylated products (Table 35). This selectivity differs from the one observed by N. Kamigata et al. in the case of ruthenium catalysts, where isomeric mixtures of α- and β-functionalized pyrroles were produced [101,104].

In 2001, Q.-Y. Chen and coworkers also reported a nickel-catalyzed methodology, with perfluoroalkyl chlorides as perfluoroalkylating reagents and in the presence of stoichiometric amounts of zinc(0) [111]. Here also, pyrrole led to a completely regioselective α-functionalization; *N,N*-dimethylaniline only gave the *para*-substituted product, whereas it led to a mixture of *ortho*- and *para*-perfluoroalkylated compounds with the system

Table 34: Ir-catalyzed borylation / Cu-catalyzed perfluoroalkylation of the resulting arylboronic ester intermediate [37].

Product		Yield (%) ^a		Product		Yield (%) ^a	
	Me	90			CO ₂ Et	80	
	CF ₃	75			OTIPS	50	
	Cl	75			CN	70	
			87				70
			90		Me	65 ^b	
					CO ₂ - <i>t</i> -Bu	50	
	O	72					67 ^b
	S	75					

^aIsolated yields. ^b1 mol % of the iridium complex and 2 mol % of the dtbipy ligand were used.

of Huang et al.; 4-aminoanisole yielded only the compound functionalized in the *ortho*-position with regard to the amino group (Table 36). Control experiments indicated a radical pathway for the mechanism (Figure 19).

Finally, it is noteworthy that the electrochemical metal-catalyzed *ortho*-perfluoroalkylation of 2-phenylpyridine, which we already discussed for its Pd-catalyzed variant, is also catalyzed by nickel complexes (Scheme 11) [71]. Actually, the nickel-based systems provided higher yields than the palladium-based one (see section 3.1.3). Considering control voltamperometric experiments, a Ni(II)/Ni(III) catalytic cycle seemed to be operating.

3.3.4 Fe-catalyzed perfluoroalkylation of Csp²-H bonds. In this section, all the studies that we will discuss used substoichiometric amounts of Fenton's reagent (FeSO₄/H₂O₂) for the generation of perfluoroalkyl radicals.

Complementary work was carried out by E. Baciocchi et al. [112] and by F. Minisci et al. [90] in the perfluoroalkylation of pyrroles and indole and of benzene and anisole, respectively. The reactions were efficient (less than 30 min at room temperature). Better yields and regioselectivities were obtained for pyrrole derivatives than for benzene and anisole (Table 37 and Table 38). Interestingly, the order of preferential functionalization in the case of anisole here is *meta* ≈ *para* > *ortho*; on the

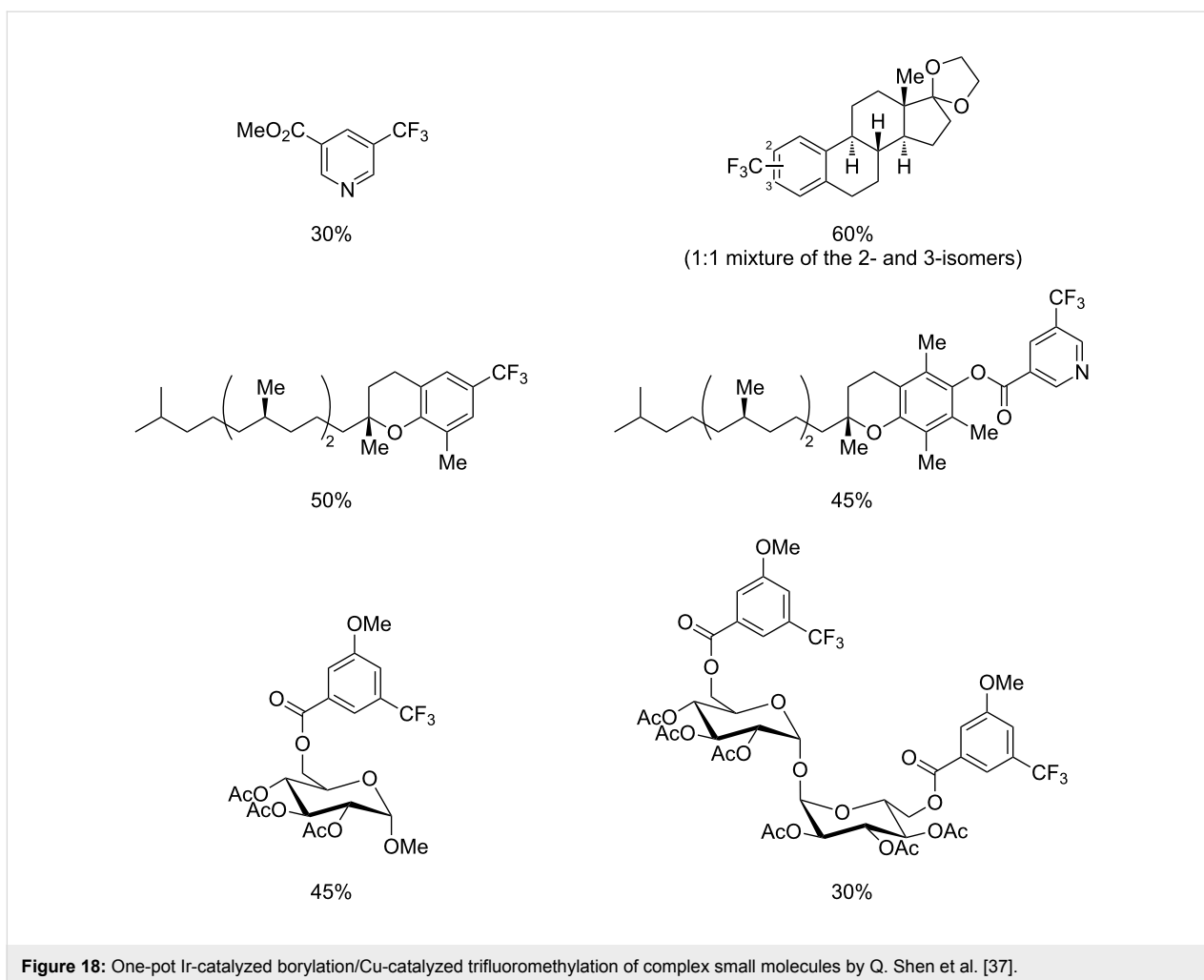
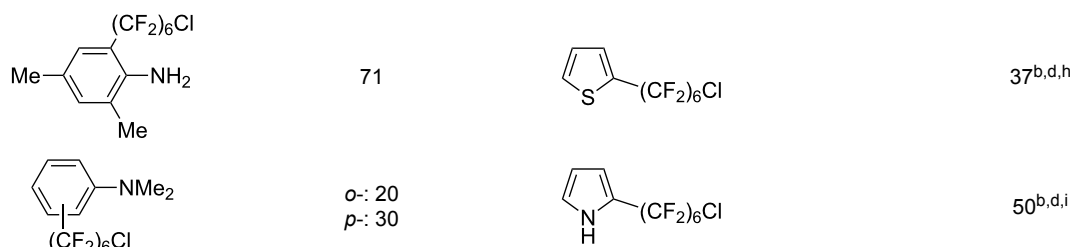

Table 35: Ni-catalyzed perfluoroalkylation of anilines, benzene, furan, thiophene and pyrrole using ω -chloroperfluoroalkyl iodides [109,110].

$(\text{Het})\text{Ar}-\text{H} + \text{Cl}(\text{CF}_2)_n\text{I}$ (2 equiv)		$\xrightarrow[\text{dioxane, 80 }^\circ\text{C, 6 h}]{\text{Ni}(\text{PPh}_3)_4 \text{ (5 mol \%)}} \text{HetAr}-(\text{CF}_2)_n\text{Cl}$	
Product	Yield (%) ^a	Product	Yield (%) ^a
 $(\text{CF}_2)_6\text{Cl}$	o :- 40 p :- 45	 $(\text{CF}_2)_n\text{Cl}$	$n = 2$ o :- 22; p :- 65 $n = 4$ o :- 21; p :- 63 $n = 6$ o :- 16; p :- 50
 $(\text{CF}_2)_6\text{Cl}$	o :- 34 p :- 48	 $(\text{CF}_2)_n\text{Cl}$	$n = 4$ 96 ^{b,c,d} $n = 6$ 91 ^{b,c,d}
 $(\text{CF}_2)_6\text{Cl}$	79	 $(\text{CF}_2)_n\text{Cl}$	$n = 4$ 95 ^{b,d,e} $n = 6$ 93 ^{b,d,f} $n = 8$ 90 ^{b,d,g}

Table 35: Ni-catalyzed perfluoroalkylation of anilines, benzene, furan, thiophene and pyrrole using ω -chloroperfluoroalkyl iodides [109,110]. (continued)

^a ¹⁹F NMR yield based on the perfluoroalkyl iodide. ^b Isolated yield. ^c Benzene itself served as solvent. ^d NaH (2 equiv) was used as additive to trap HI. ^e 60 °C, 3 h. ^f 60 °C, 5 h. ^g 60 °C, 8 h. ^h 80 °C, 4 h. ⁱ 80 °C, 3 h.

Table 36: Ni-catalyzed methodology, with perfluoroalkyl chlorides as perfluoroalkylating reagents in the presence of stoichiometric zinc(0) [111].

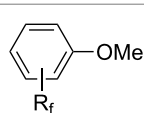
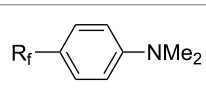
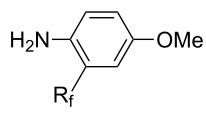
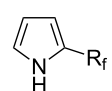
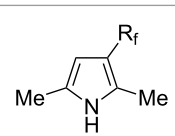
$(\text{Het})\text{Ar}-\text{H}$ (1.5 equiv)		+	R_fCl $\text{R}_f = (\text{CF}_2)_4\text{H}$ $n\text{-C}_6\text{F}_{13}$ $n\text{-C}_8\text{F}_{17}$	$\xrightarrow[\text{DMF, 95-100 }^\circ\text{C, 6-8 h}]{\text{NiCl}_2 (10 \text{ mol } \%)$ $\text{PPh}_3 (40 \text{ mol } \%)$ $\text{Zn powder (1.5 equiv)}$	$(\text{Het})\text{Ar}-\text{R}_f$
Product			R_f	Isolated yield (%) ^a	Isomer ratio ^b
			$n\text{-C}_6\text{F}_{13}$ $n\text{-C}_8\text{F}_{17}$	62 71	<i>o/m/p</i> = 44:18:38 <i>o/m/p</i> = 48:20:32
			$n\text{-C}_6\text{F}_{13}$ $n\text{-C}_8\text{F}_{17}$	65 60	--- ---
			$n\text{-C}_6\text{F}_{13}$ $n\text{-C}_8\text{F}_{17}$	56 58	--- ---
			$(\text{CF}_2)_4\text{H}$ $n\text{-C}_6\text{F}_{13}$ $n\text{-C}_8\text{F}_{17}$	75 78 76	--- ---
			$(\text{CF}_2)_4\text{H}$ $n\text{-C}_6\text{F}_{13}$ $n\text{-C}_8\text{F}_{17}$	68 70 70	--- ---

^aBased on the starting perfluoroalkyl chloride. ^bDetermined by ¹⁹F NMR.

contrary, all of the other perfluoroalkylation reactions of C–H bonds of anisole discussed so far and those we will discuss later [113] yielded *ortho*-perfluoroalkylated anisoles as the major

products. F. Minisci and coworkers also obtained similar results when using a catalytic iron(III) salt in the presence of *tert*-butyl peroxide as oxidant.

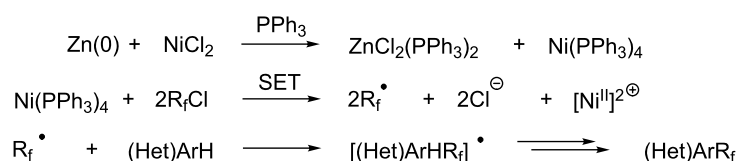
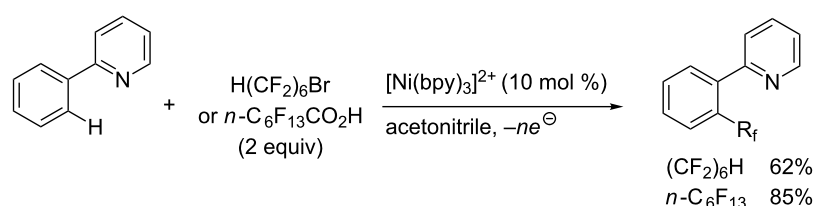

Figure 19: Mechanistic proposal for the Ni-catalyzed perfluoroalkylation of arenes and heteroarenes with perfluoroalkyl chlorides by Q.-Y. Chen and coworkers [111].



Scheme 11: Electrochemical Ni-catalyzed perfluoroalkylation of 2-phenylpyridine (Y. H. Budnikova et al.) [71].

Table 37: Perfluoroalkylation of pyrroles employing Fenton's reagent [112].

Product	R _f	Yield (%) ^a	Product	R _f	Yield (%) ^a
	<i>n</i> -C ₄ F ₉ l	78 ^b		<i>n</i> -C ₄ F ₉ l	71
	<i>n</i> -C ₄ F ₉ l <i>n</i> -C ₃ F ₇ l <i>i</i> -C ₃ F ₇ l	55 64 73		<i>n</i> -C ₃ F ₇ l	36
	<i>n</i> -C ₄ F ₉ l	73		<i>n</i> -C ₃ F ₇ l	30

^aIsolated yields, unless otherwise noted. ^bGC yield.

T. Yamakawa et al. applied this Fenton-based generation of perfluoroalkyl radicals for the trifluoromethylation of uracil derivatives [114] as well as of various arenes and heteroarenes (pyridines, pyrimidines, pyrazines, quinolines, pyrroles, thiophenes, furans, pyrazoles, imidazoles, thiazoles, oxazoles, thiazoles, triazoles) [115]. The yields were low to excellent, depending on the substrate (Scheme 12 and Figure 20). Iron(II) sulfate and ferrocene were used alternately as catalysts in the presence or not of sulfuric acid, but other metals proved inac-

tive. The procedures could be adapted to larger-scale synthesis (10 g).

3.3.5 Fe-catalyzed trifluoromethylation of arylboron reagents. S. L. Buchwald et al. developed an iron(II)-catalyzed trifluoromethylation of potassium vinyltrifluoroborates employing Togni's reagent. The products are obtained in good yields and good to excellent *E/Z* ratios (Table 39) [116].

Table 38: Perfluoroalkylation of benzenes or anisoles employing Fenton's reagent [90].

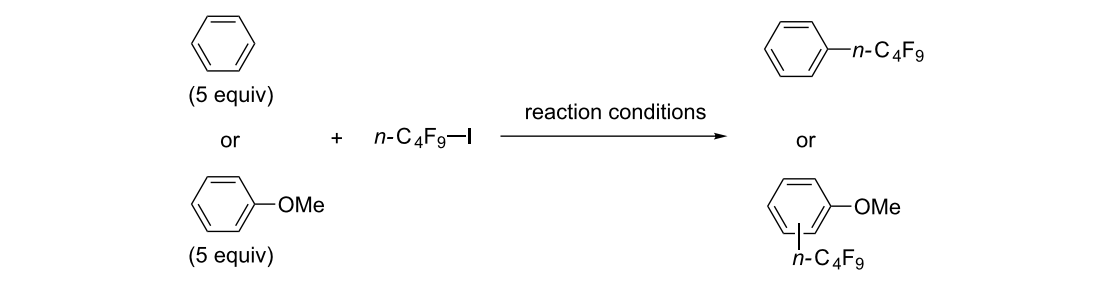
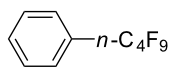
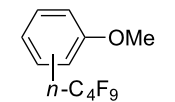
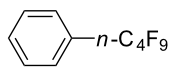
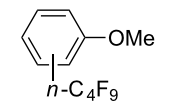
Product	Reaction conditions	Conversion of <i>n</i> -C ₄ F ₉ I (%) ^a	Yield (%) ^b	Isomer ratio
				
	FeSO ₄ ·7H ₂ O (70 mol %) 35% H ₂ O ₂ (3 mmol) DMSO, rt	41.9	95.4	---
		42.2	97.6	<i>o</i> / <i>m</i> / <i>p</i> = 16.1:43.4:40.5
	Fe(OAc) ₂ OH (20 mol %) <i>t</i> -BuOOH (2 equiv) AcOH, 115 °C	58.1	96.1	---
		57.7	94.8	<i>o</i> / <i>m</i> / <i>p</i> = 15.5:42.8:41.7

^aDetermined by ¹⁹F NMR. ^bDetermined by GC or GCMS.

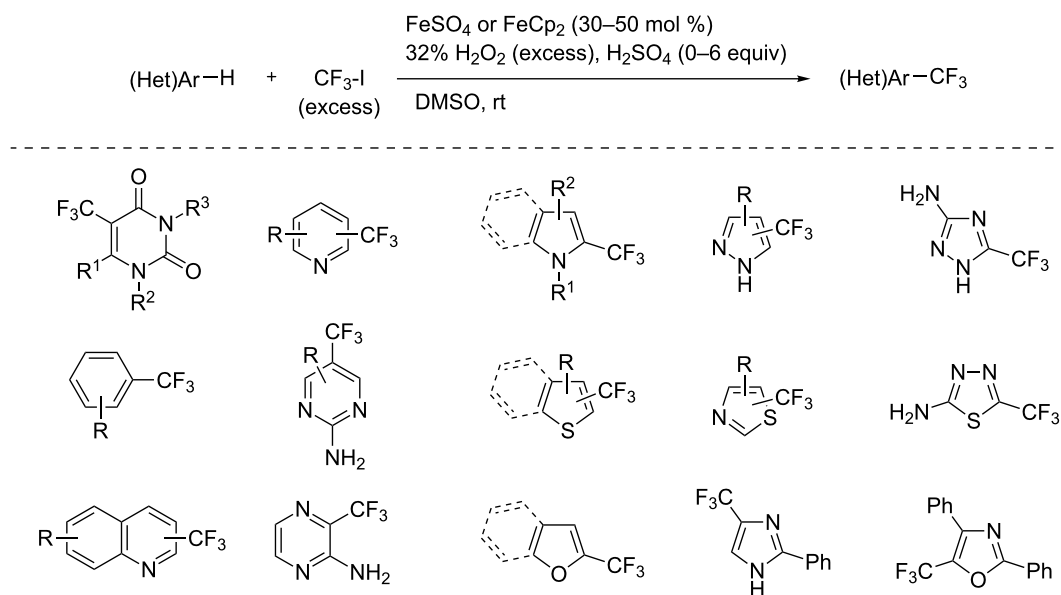
**Scheme 12:** Fe(II)-catalyzed trifluoromethylation of arenes and heteroarenes with trifluoromethyl iodide (T. Yamakawa et al.) [114,115].

3.3.6 Ag-catalyzed fluorodecarboxylation for the synthesis of trifluoromethylarenes. An alternative approach to access trifluoromethyl arenes without the use of trifluoromethylating

reagents rely on an aryl CF₂-F bond disconnection. A clever example of this strategy has been described by V. Gouverneur et al. starting from aryl difluoroacetic acids [117]. The latter

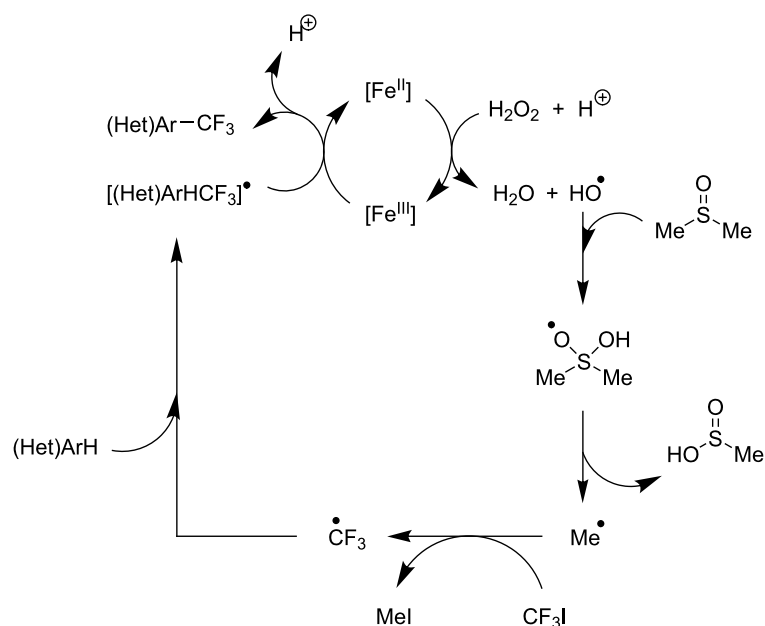
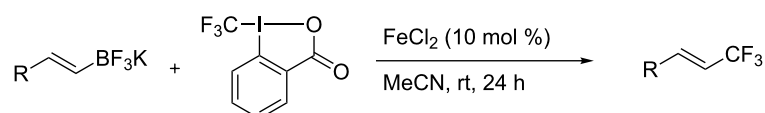

Figure 20: Mechanistic proposal by T. Yamakawa et al. for the Fe(II)-catalyzed trifluoromethylation of arenes and heteroarenes with trifluoromethyl iodide [114].

Table 39: Fe(II)-catalyzed trifluoromethylation of potassium vinyltrifluoroborates employing Togni's reagent [116].



Compound	Yield (%)	Compound	Yield (%)	Compound	Yield (%)
	70		78		75
	68		70		65
	65		49		74
	34		66		79

can react with Selectfluor[®] and a catalytic amount of silver nitrate with good functional groups tolerance including ether, halide, ketone and amide. However, the presence of electron-withdrawing groups on the aromatic ring significantly decreases

the yield of the transformation (Table 40). The benzylic radical generated during the reaction is probably stabilized by the two geminal fluorine atoms, by adopting an all planar geometry [118].

Table 40: Ag-catalyzed fluorodecarboxylation for the synthesis of trifluoromethylarenes [117].

Compound	Yield (%)	Compound	Yield (%)	Compound	Yield (%)
	86		77		66
	82		86		88
	51		86		49
	56		83		17
	49		21		24

3.3.7 Miscellaneous metals in the catalyzed perfluoroalkylation of Csp²-H bonds. In 1993, Y. Ding et al. described an ytterbium-catalyzed hydroperfluoroalkylation of alkenes with perfluoroalkyl iodides. Among them, dihydropyran led instead to the product of C-H perfluoroalkylation β to the oxygen atom

[119]. The reaction proceeded in the presence of Zn dust, which was believed to serve as a reductant for the in situ generation of Yb(II) species. The latter would then be able to transfer an electron to the perfluoroalkyl iodide and generate the corresponding radical (Scheme 13).

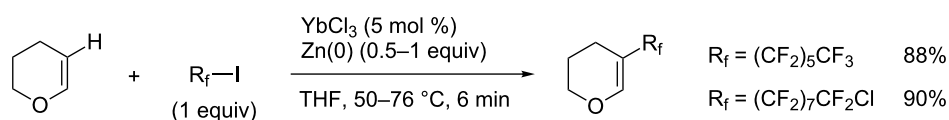

Proposed mechanism

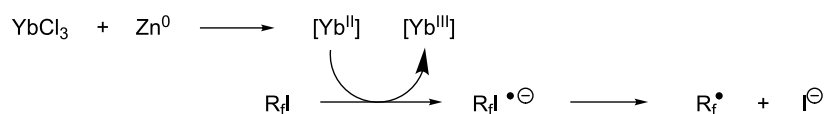
**Scheme 13:** Ytterbium-catalyzed perfluoroalkylation of dihydropyran with perfluoroalkyl iodide (Y. Ding et al.) [119].

Titanium dioxide was used as heterogeneous photocatalyst in the perfluoroalkylation of α -methylstyrene with perfluorohexyl iodide by M. Yoshida et al. [120]. While the main product arose from the formal perfluoroalkylation of a methyl sp^3 -C–H bond, a byproduct corresponding to the functionalization of a methylene sp^2 -C–H bond was also obtained. The authors later applied this methodology to the perfluoroalkylation of arene C–H bonds (Table 41) [121]. The addition of methanol as an additive appeared critical playing the role of “hole shuttle”, and balancing the electron transfer to the perfluoroalkyl iodide.

In 2010, A. Togni and coworkers studied the trifluoromethylation of pyrroles, indoles, and various other heteroarenes or arenes in the presence of zinc salts, and with Togni’s hypervalent iodine reagents as the CF_3 -source. Yields were highly dependent on the nature of the substrate; zinc catalysts were even sometimes detrimental to the reaction, because they facilitated the competitive decomposition of the starting material [122].

A more successful approach was later devised by the same group [113]. With methyltrioxorhenium as a catalyst and Togni’s benziiodoxolone reagent, a wide scope of aromatic and heteroaromatic compounds was trifluoromethylated with modest to good yields; even ferrocene could serve as substrate

and was trifluoromethylated on one of the Cp rings. Mixtures of isomers were obtained for unsymmetrical starting materials; for instance, anisole and chloro- or iodobenzene gave an *ortho* > *para* \approx *meta* preferential order of substitution, while toluene, acetophenone, *N,N*-dimethylaniline or nitrobenzene afforded the *para*-substituted compound as the major product. The reaction could be monitored by EPR, which showed an induction period and demonstrated the involvement of radical species in the reaction. The authors proposed a mechanism accounting for the EPR profile of the reaction and for the results of kinetic isotope effect experiments (Figure 21). In this mechanism, rhenium intervenes in the initiation step. It acts as a Lewis acid and activates the hypervalent iodine reagent, which is thus able to accept an electron by the substrate; this leads to the formation of a caged pair (aryl cation radical/reduced Togni’s reagent–rhenium complex), where iodine then transfers a CF_3^- anion to the aryl cation. This recent methodology has already been applied the same year by others for the synthesis of trifluoromethylated corannulenes [123].

We discussed earlier the influence of copper sulfate on the trifluoromethylation of heteroarenes with Langlois’s reagent in the presence of *tert*-butyl peroxide (P. S. Baran et al.) [89]. In the same paper, the authors showed that cobalt perchlorate could also improve the yield of the uncatalyzed reaction. Iron

Table 41: TiO_2 -photocatalytic perfluoroalkylations of benzenes [121].

Product	Yield (%) ^a	Product	Yield (%) ^a
	51 ^b		44 ^c
	72 ^b		43
	13 ^b		

^aIsolated yields based on the starting perfluorohexyl iodide, unless otherwise noted. ^bHPLC yield. ^c6:1 isomer mixture; the major isomer is represented.

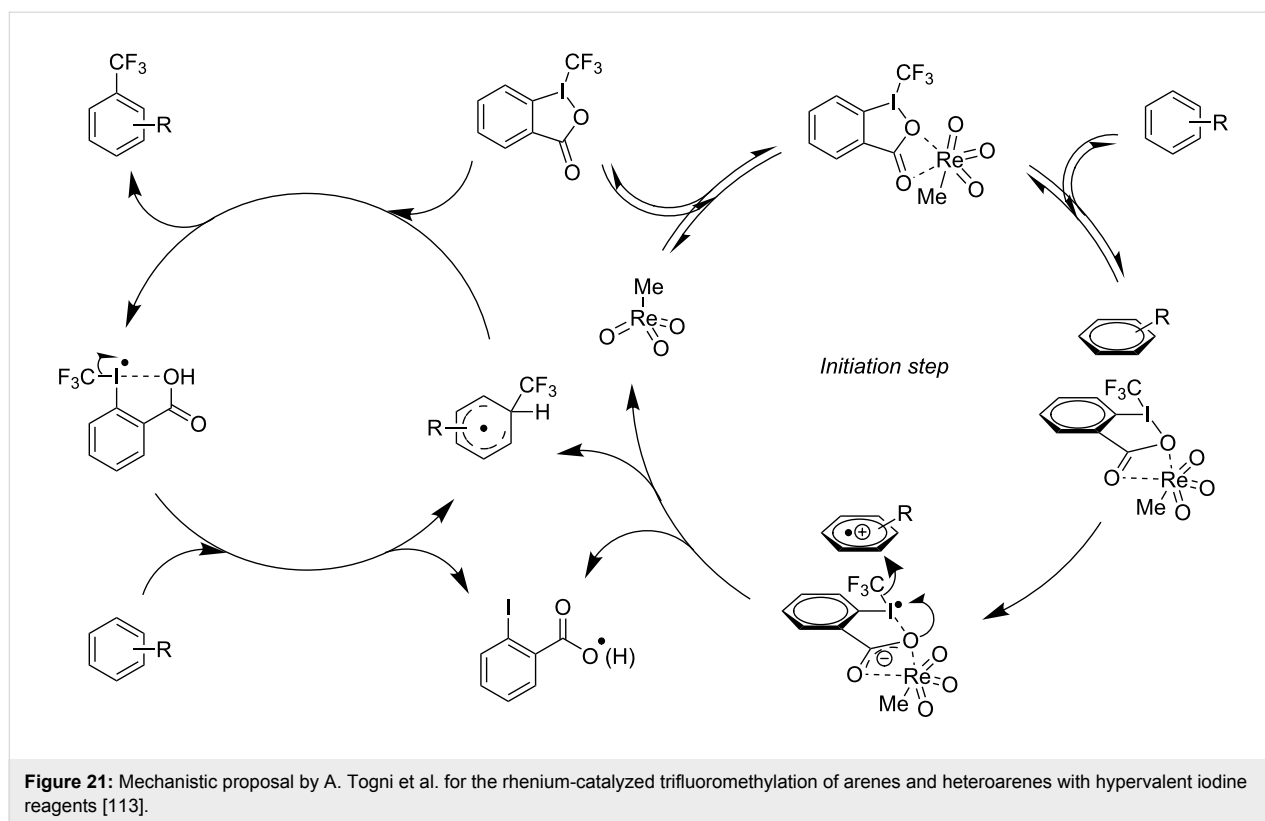

sulfate, on the other hand, gave the same yield as in the absence of added metals.

4 Catalytic trifluoromethylthiolation

Aryl trifluoromethyl sulfides (ArSCF_3) play an important role in pharmaceutical [124] and agrochemical research [16,125]. The trifluoromethylthio group belongs to the most lipophilic substituents as expressed by the Hansch lipophilicity parameter ($\pi = 1.44$) [126-129] and the high electronegativity of the SCF_3 group improves significantly the stability of molecules in acidic medium. One can place this substituent next to the ever-present CF_3 and the emerging OCF_3 substituent [55,56,130]. In contrast, aryl trifluoromethyl sulfides are key intermediates for the preparation of trifluoromethyl sulfoxides or sulfones.

Aryl trifluoromethyl sulfides can be obtained via reaction of trifluoromethylthiolate with an electrophile like aryl halides. On the other hand, they can also be obtained by reacting aryl sulfides or disulfides under nucleophilic or radical conditions with a trifluoromethylation reagent [16,55,124]. Very recently, several elegant approaches dealing with the direct introduction of the SCF_3 -moiety have been developed in this field [131-133].

4.1 Palladium catalysis

S. L. Buchwald reported on the Pd-catalyzed reaction of aryl bromides with a trifluoromethylthiolate. Good to excellent

yields of aryl trifluoromethyl sulfides have been achieved under mild conditions and the reaction has been extended to a wide range of aryl- and heteroaryl bromides (Table 42) [134]. This approach employs AgSCF_3 as SCF_3 source in order to circumvent the fact that many convenient SCF_3 salts are thermally unstable.

The drawbacks of this approach are the use of an expensive ligand, an expensive palladium salt, a quaternary ammonium additive, and a stoichiometric amount of an expensive silver SCF_3 derivative.

4.2 Copper catalysis

F.-L. Qing was the first to report on a copper-catalyzed oxidative trifluoromethylthiolation of arylboronic acids with the Ruppert–Prakash reagent TMSCF_3 and elemental sulfur (Table 43) [135]. This protocol is quite efficient, simple and allows for large functional group compatibility under mild reaction conditions. Another strength of the approach is that easily accessible starting materials are employed in presence of a "green" inexpensive catalyst system.

The putative mechanism is based on the formation of a Cu(I) disulfide complex generated in situ, which reacts with arylboronic acids and TMSCF_3 according to two possible pathways

Table 42: Pd-catalyzed reaction of aryl bromides with trifluoromethylthiolate [134].

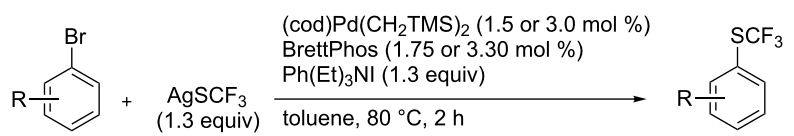
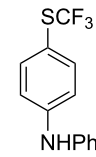
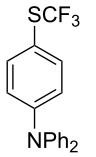
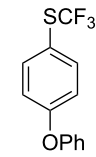
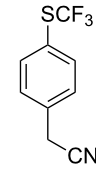
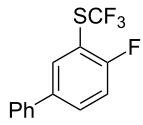
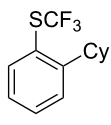
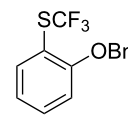
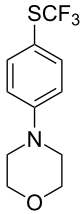
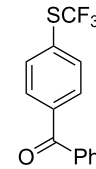
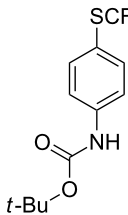
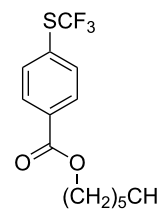
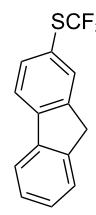
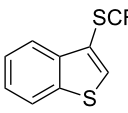
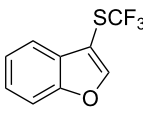
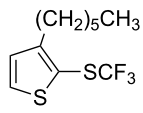
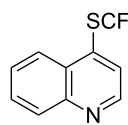
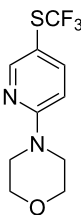
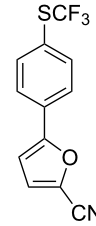
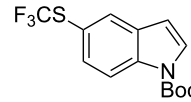
					
Compound	Yield (%)	Compound	Yield (%)	Compound	Yield (%)
	98		98		97
	97		96		93
	96		99		83
	91		98		97
	94		81		93
	96		98		96
	98				

A and B (Figure 22) leading to the intermediate complex $L_nCu(CF_3)(SAr)$ or $L_nCu(Ar)(SCF_3)$, respectively. Oxidation and reductive elimination gives then the expected aryl trifluoromethyl thioether.

O. Daugulis reported on the copper-catalyzed trifluoromethylthiolation via C–H activation of 8-aminoquinoline acid amides in presence of disulfide reagents and $Cu(OAc)_2$ in DMSO (Table 44) [136]. The use of inexpensive copper acetate and the

Table 43: Cu-catalyzed oxidative trifluoromethylthiolation of aryl boronic acids with TMSCF₃ and elemental sulfur [135].

$\text{R-C}_6\text{H}_4\text{-B(OH)}_2 + \text{S}_8 + \text{TMSCF}_3 \xrightarrow[\text{DMF, 4 \AA MS, rt}]{\text{CuSCN (10 mol \%), phen (20 mol \%), K}_3\text{PO}_4, \text{Ag}_2\text{CO}_3} \text{R-C}_6\text{H}_4\text{-SCF}_3$					
Compound	Yield (%)	Compound	Yield (%)	Compound	Yield (%)
	82		64		91
	86		84		84
	90		78		67
	70		89		71
	61		58		66

**Figure 22:** Mechanism of the Cu-catalyzed oxidative trifluoromethylthiolation of arylboronic acids with TMSCF₃ and elemental sulfur [135].

Table 44: Cu-catalyzed trifluoromethylthiolation via C–H activation [136].

Compound	Yield (%)	Compound	Yield (%)
	76		67
	73		70
	72		63
	59		70
	43		59

removable directing group are significant advantages of this approach. Bromide, ester, and chloride functionalities are tolerated and the reaction has been applied to aromatic as well as five- and six-membered heterocyclic substrates.

The 8-aminoquinoline auxiliary can be easily removed affording the trifluoromethylthiolated acid (Scheme 14).

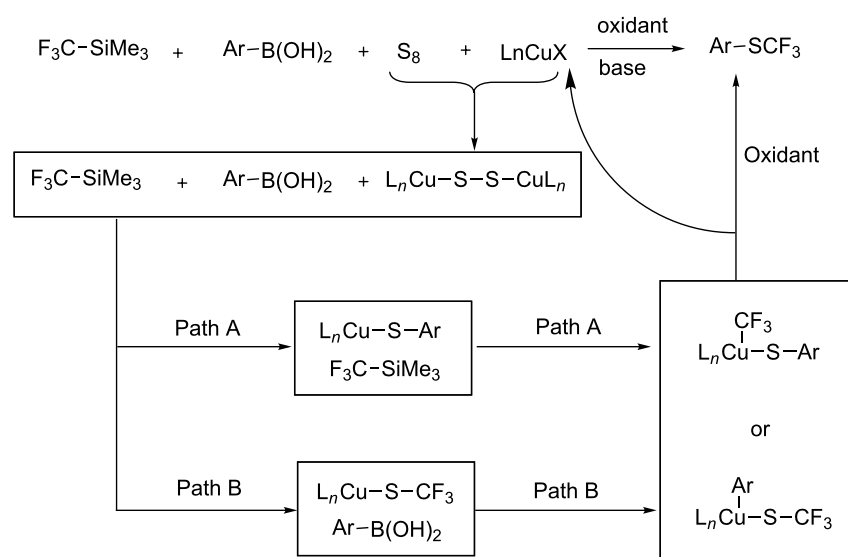
L. Lu and Q. Shen reported on the use of an electrophilic trifluoromethylthio reagent based on Togni's hypervalent iodine

reagent for trifluoromethylation reactions (Table 45) [137]. Trifluoromethylthiolation of various substrates, such as β -ketoesters, aldehydes, amides, aryl, or vinyl boronic acids, or alkynes, have been achieved under mild conditions.

In order to avoid the preparation of trifluoromethylthiolation reagents by trifluoromethylations of sulfides, N. Shibata studied an approach based on the use of the easily accessible trifluoromethanesulfonyl (CF_3SO_2) unit which is stable and often found in commonly used organic reagents such as $\text{CF}_3\text{SO}_2\text{Cl}$,

**Scheme 14:** Removal of the 8-aminoquinoline auxiliary [136].

Table 45: Cu-catalyzed trifluoromethylthiolation of boronic acids employing a hypervalent iodine reagent [137].

					
Compound	Yield (%)	Compound	Yield (%)	Compound	Yield (%)
	90		92		95
	89		87		64
	58		87		58
	65		40		75
	57				

$\text{CF}_3\text{SO}_2\text{Na}$, $\text{CF}_3\text{SO}_3\text{H}$, and $(\text{CF}_3\text{SO}_2)_2\text{O}$. They designed a new electrophilic-type trifluoromethylthiolation reagent, a trifluoromethanesulfonyl hypervalent iodonium ylide [138]. It is easily synthesized in quantitative yield by the reaction of α -trifluoromethanesulfonyl phenyl ketone and phenyliodine(III) diacetate (PIDA).

In the presence of a catalytic amount of copper(I) chloride, this reagent trifluoromethylthiolates a wide variety of nucleophiles like enamines, β -keto esters and indoles allowing the C-sp²

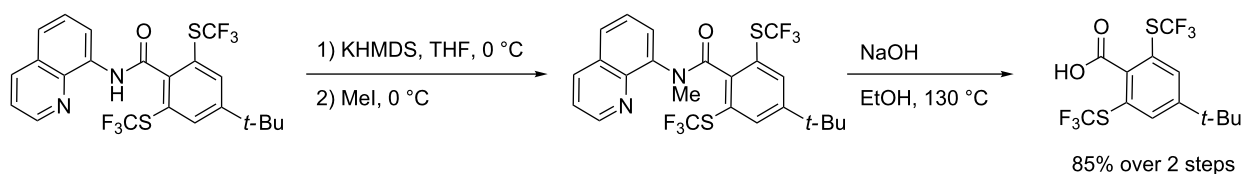
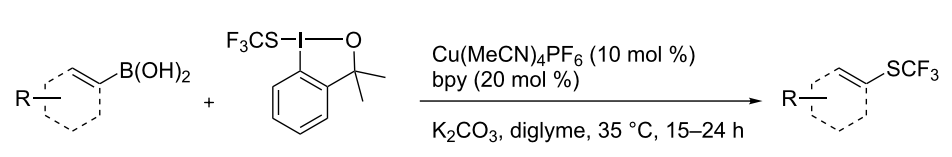
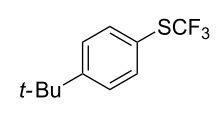
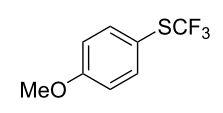
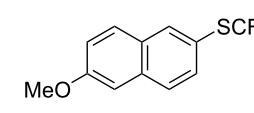
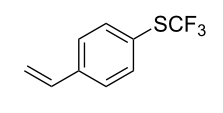
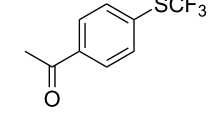
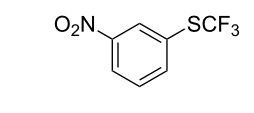
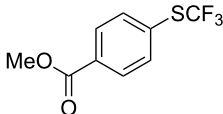
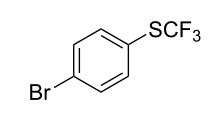
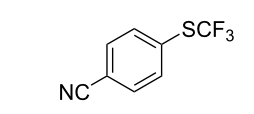
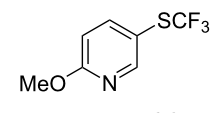
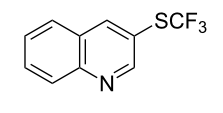
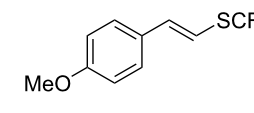
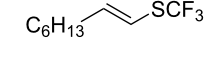
trifluoromethylthiolation of vinylic C–H (Table 46) and aromatic (Table 47) bonds.

The reasonable mechanism for this reaction is shown in Figure 23. A copper carbenoid may initially be formed and decompose to a sulfonyl carbene (Path I, Figure 23). Or, the reagent could be activated by a copper(I) salt and generate a zwitterionic intermediate, which eliminates iodobenzene to form a carbene (Path II). Next, an oxirene (in equilibrium with carbene) rearranges to sulfoxide and collapses to the true reac-

Table 46: Cu-catalyzed trifluoromethylthiolation of vinylic C–H bonds with a trifluoromethanesulfonyl hypervalent iodonium ylide [138].

			
Compound	Yield (%)	Compound	Yield (%)
	92		89

Table 46: Cu-catalyzed trifluoromethylthiolation of vinylic C–H bonds with a trifluoromethanesulfonyl hypervalent iodonium ylide [138]. (continued)

	82		89
	77		75
	88		90
	87		94
	96		94
	94		84
	97		84
	74		84

tive species, thioperoxoate. Electrophilic transfer trifluoromethylthiolation to the nucleophile then yields the desired products (Path III). In presence of an amine, a trifluoromethylthiolated ammonium salt might be formed which is subsequently attacked by the nucleophile yielding the final product (Path IV).

4.3 Nickel catalysis

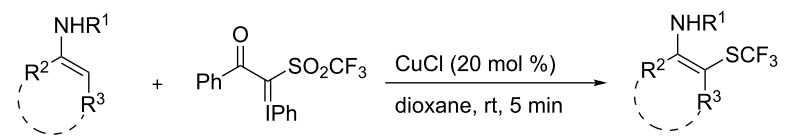
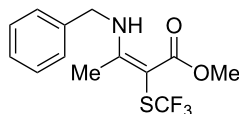
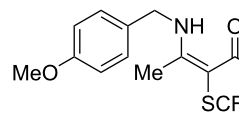
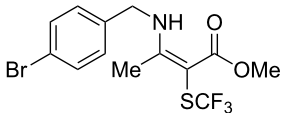
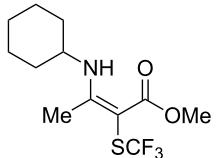
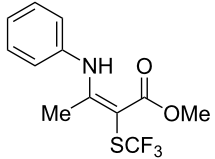
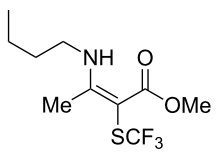
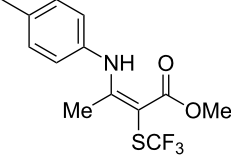
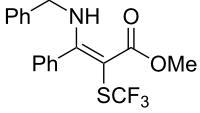
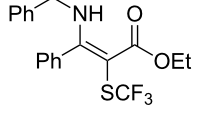
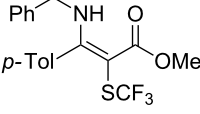
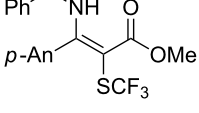
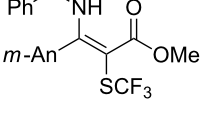
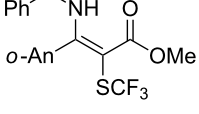
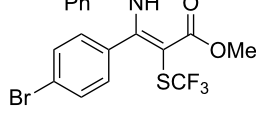
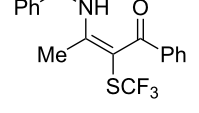
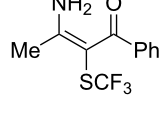
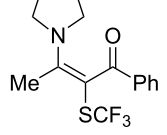
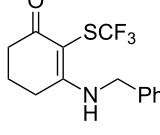
D. A. Vicic studied the use of the cheaper and more soluble $[\text{NMe}_4][\text{SCF}_3]$ reagent instead of AgSCF_3 used by S. L. Buchwald in his studies [125]. However, one major constraint in the use of this reagent is that transition metal-catalyzed reactions

have to be realized under extremely mild and anhydrous conditions. This inspired this group to employ a bipyridine nickel system as a catalyst in order to activate aryl halides at room temperature. They could show that the nickel catalyst allows the efficient incorporation of the SCF_3 functionality into a variety of aryl halides. Electron-rich aryl halides were better substrates than electron-poor analogues (Table 48).

Conclusion

Over the last two years or so, organofluorine chemistry has made an important step forward by adding transition metal catalysis to its toolbox, to the benefit of chemists working in

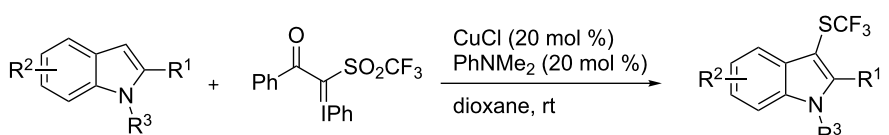
Table 47: Cu-catalyzed trifluoromethylthiolation of aromatic C–H bonds with a trifluoromethanesulfonyl hypervalent iodonium ylide [138].

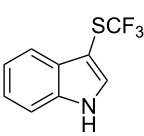
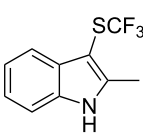
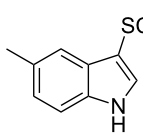
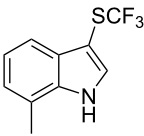
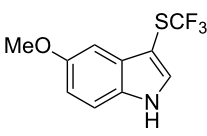
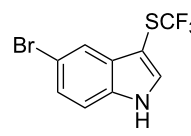
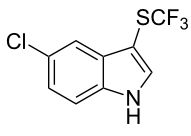
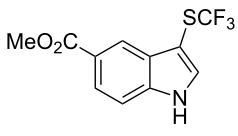
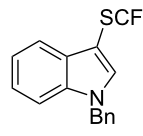
Compound	Yield (%)	Compound	Yield (%)	Compound	Yield (%)
	83		83		6%
	73		36		71
	52		32		84

**Figure 23:** Mechanism of the Cu-catalyzed trifluoromethylthiolation of C–H bonds with a trifluoromethanesulfonyl hypervalent iodonium ylide [138].

Table 48: Ni-catalyzed trifluoromethylthiolation of aryl halides with $[\text{NMe}_4][\text{SCF}_3]$ [125].

Compound	Yield (%)	Compound	Yield (%)	Compound	Yield (%)
	Cl: 0 Br: 65		I: 90		I: 90
	I: 45		I: 47		I: 0
	I: 83		Br: 37		I: 55
	Br: 64 I: 92		I: 91		

pharmaceuticals, agrochemicals and material sciences or diagnosis. Reactions that have been unimaginable some years ago have been the focus of researchers, many of them not necessarily experts in fluorine chemistry. In particular the organometallic chemistry community has contributed significantly. Despite this exciting progress, the catalytic introduction of fluorine and fluorinated groups is still in its infancy and much skill needs to be revealed regarding mechanism, the nature and amount of the metal employed and scale up of reactions for industrial applications.

This "Small atom with a big ego" (title of the ACS Symposium in San Francisco in 2000) will without any doubt continue to have a brilliant future.

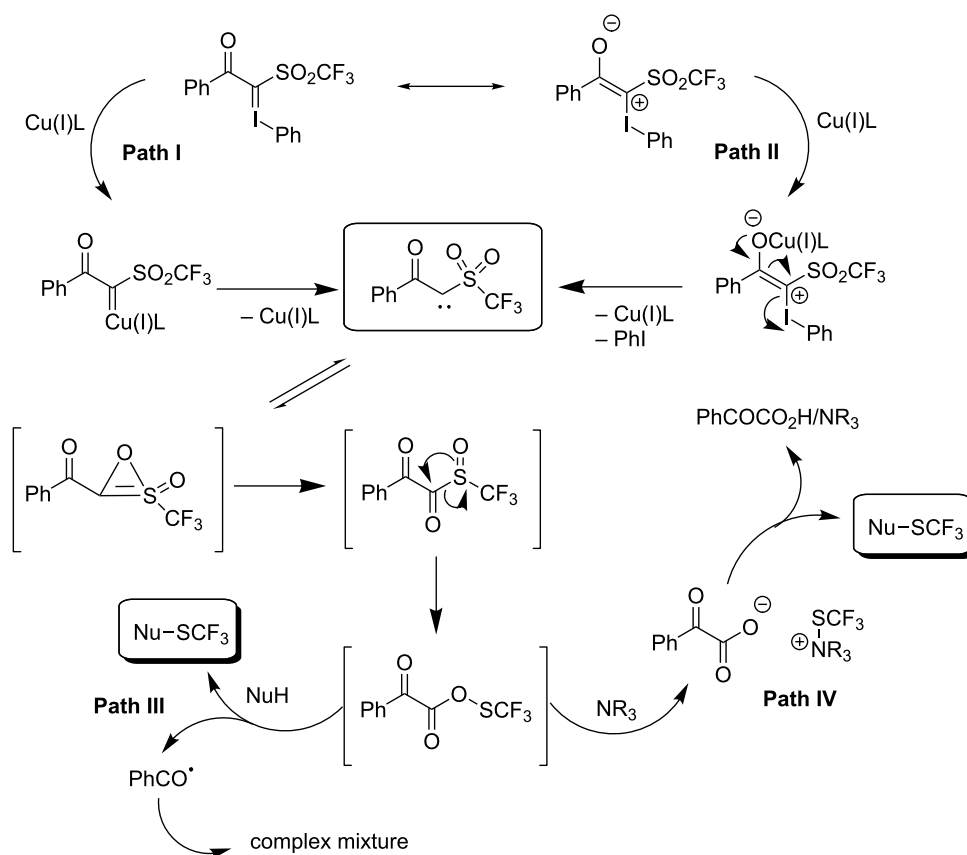
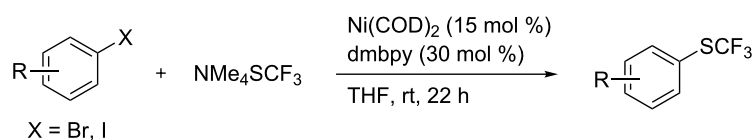
Acknowledgements

We thank the Centre National de la Recherche Scientifique (CNRS) France for financial support and are much grateful to Bayer CropScience for a Postdoctoral fellowship to G.L. The French Fluorine Network (GIS Fluor) is also acknowledged.

References

- Banks, R. E.; Smart, B. E.; Tatlow, J. C., Eds. *Organofluorine Chemistry: Principles and Commercial Applications*; Plenum Press: New York, 2000.
- Hiyama, T.; Kanie, K.; Kusumoto, T.; Morizawa, Y.; Shimizu, M. *Organofluorine Compounds: Chemistry and Application*; Springer-Verlag: Berlin, 2000.
- Kirsch, P. *Modern Fluoroorganic Chemistry*; Wiley-VCH: Weinheim, Germany, 2004. doi:10.1002/352760393X
- Chambers, R. D. *Fluorine in Organic Chemistry*; Blackwell: Oxford, U.K., 2004.
- Uneyama, K. *Organofluorine Chemistry*; Blackwell: Oxford, U.K., 2006. doi:10.1002/9780470988589
- Bégué, J.-P.; Bonnet-Delpon, D. *Bioorganic and Medicinal Chemistry of Fluorine*; John Wiley and Sons: Hoboken, 2008.
- Purser, S.; Moore, P. R.; Swallow, S.; Gouverneur, V. *Chem. Soc. Rev.* **2008**, *37*, 320–330. doi:10.1039/b610213c
- Gouverneur, V.; Muller, K., Eds. *Fluorine in Pharmaceutical and Medicinal Chemistry: From Biophysical Aspects to Clinical Applications*; Imperial College Press, 2012.
- Ojima, I., Ed. *Fluorine In Medicinal Chemistry And Chemical Biology*; John Wiley & Sons Ltd., 2009.
- Müller, K.; Faeh, C.; Diederich, F. *Science* **2007**, *317*, 1881–1886. doi:10.1126/science.1131943
- Kirk, K. L. *J. Fluorine Chem.* **2006**, *127*, 1013–1029. doi:10.1016/j.jfluchem.2006.06.007
- Kirk, K. L. *Curr. Top. Med. Chem.* **2006**, *6*, 1447–1456. doi:10.2174/156802606777951073
- O'Hagan, D. *Chem. Soc. Rev.* **2008**, *37*, 308–319. doi:10.1039/b711844a
- Isanbor, C.; O'Hagan, D. *J. Fluorine Chem.* **2006**, *127*, 303–319. doi:10.1016/j.jfluchem.2006.01.011
- Jeschke, P.; Baston, E.; Leroux, F. R. *Mini-Rev. Med. Chem.* **2007**, *7*, 1027–1034. doi:10.2174/138955707782110150
- Leroux, F.; Jeschke, P.; Schlosser, M. *Chem. Rev.* **2005**, *105*, 827–856. doi:10.1021/cr040075b

17. Jeschke, P. *Pest Manag. Sci.* **2010**, *66*, 10–27. doi:10.1002/ps.1829
18. Kraemer, W.; Schirmer, U.; Jeschke, P.; Witschel, M., Eds. *Modern Crop Protection Compounds*, 2nd ed.; Wiley-VCH Verlag GmbH & Co. KGaA: Weinheim, Germany, 2012.
19. *Modern Methods*. In *Crop Protection Research*; Jeschke, P.; Kraemer, W.; Schirmer, U.; Witschel, M., Eds.; Wiley-VCH Verlag GmbH & Co. KGaA: Weinheim, Germany, 2012.
20. Jeschke, P. *ChemBioChem* **2004**, *5*, 570–589. doi:10.1002/cbic.200300833
21. Emsley, J. *Chem. Soc. Rev.* **1980**, *9*, 91–124.
22. Liang, T.; Neumann, C. N.; Ritter, T. *Angew. Chem., Int. Ed.* **2013**, *52*, 8214–8264. doi:10.1002/anie.201206566
23. Furuya, T.; Kamlet, A. S.; Ritter, T. *Nature* **2011**, *473*, 470–477. doi:10.1038/nature10108
24. Jin, Z.; Hammond, G. B.; Xu, B. *Aldrichimica Acta* **2012**, *45*, 67–83.
25. Liu, H.; Gu, Z.; Jiang, X. *Adv. Synth. Catal.* **2013**, *355*, 617–626. doi:10.1002/adsc.201200764
26. Sanford, M. S.; Ye, Y. *Synlett* **2012**, *23*, 2005–2013. doi:10.1055/s-0032-1316988
27. Tomashenko, O. A.; Grushin, V. V. *Chem. Rev.* **2011**, *111*, 4475–4521. doi:10.1021/cr1004293
28. Besset, T.; Schneider, C.; Cahard, D. *Angew. Chem., Int. Ed.* **2012**, *51*, 5048–5050. doi:10.1002/anie.201201012
29. Bauer, H.; Fritz-Wolf, K.; Winzer, A.; Kühner, S.; Little, S.; Yardley, V.; Vezin, H.; Palfey, B.; Schirmer, R. H.; Davioud-Charvet, E. *J. Am. Chem. Soc.* **2006**, *128*, 10784–10794. doi:10.1021/ja061155v
30. Boehringer, M.; Fischer, H.; Hennig, M.; Hunziker, D.; Huwlyer, J.; Kuhn, B.; Loeffler, B. M.; Luebbbers, T.; Mattei, P.; Narquizian, R.; Sebokova, E.; Sprecher, U.; Wessel, H. P. *Biol. Med. Chem. Lett.* **2010**, *20*, 1106–1108. doi:10.1016/j.bmcl.2009.12.025
31. Oh, S.-J.; Lee, K. C.; Lee, S.-Y.; Ryu, E. K.; Saji, H.; Choe, Y. S.; Chi, D. Y.; Kim, S. E.; Lee, J.; Kim, B.-T. *Bioorg. Med. Chem.* **2004**, *12*, 5505–5513. doi:10.1016/j.bmc.2004.08.011
32. Ahmed, V.; Liu, Y.; Taylor, S. D. *ChemBioChem* **2009**, *10*, 1457–1461. doi:10.1002/cbic.200900143
33. Oishi, M.; Kondo, H.; Amii, H. *Chem. Commun.* **2009**, 1909–1911. doi:10.1039/b823249k
34. Chu, L.; Qing, F.-L. *Org. Lett.* **2010**, *12*, 5060–5063. doi:10.1021/ol1023135
35. Litvinas, N. D.; Fier, P. S.; Hartwig, J. F. *Angew. Chem., Int. Ed.* **2012**, *51*, 536–539. doi:10.1002/anie.201106668
36. Chen, Q.-Y.; Wu, S.-W. *J. Chem. Soc., Chem. Commun.* **1989**, 705–706. doi:10.1039/C39890000705
37. Liu, T.; Shao, X.; Wu, Y.; Shen, Q. *Angew. Chem., Int. Ed.* **2012**, *51*, 540–543. doi:10.1002/anie.201106673
38. Cho, E. J.; Senecal, T. D.; Kinzel, T.; Zhang, Y.; Watson, D. A.; Buchwald, S. L. *Science* **2010**, *328*, 1679–1681. doi:10.1126/science.1190524
39. Zhang, C.-P.; Wang, Z.-L.; Chen, Q.-Y.; Zhang, C.-T.; Gu, Y.-C.; Xiao, J.-C. *Angew. Chem., Int. Ed.* **2011**, *50*, 1896–1900. doi:10.1002/anie.201006823
40. McLoughlin, V. C. R.; Thrower, J. *Tetrahedron* **1969**, *25*, 5921–5940. doi:10.1016/S0040-4020(01)83100-8
41. Kobayashi, Y.; Kumadaki, I. *Tetrahedron Lett.* **1969**, *10*, 4095–4096. doi:10.1016/S0040-4039(01)88624-X
42. Hu, J.; Zhang, W.; Wang, F. *Chem. Commun.* **2009**, 7465–7478. doi:10.1039/b916463d
43. Zhu, J.; Zhang, W.; Zhang, L.; Liu, J.; Zheng, J.; Hu, J. *J. Org. Chem.* **2010**, *75*, 5505–5512. doi:10.1021/jo1005262
44. Doi, H.; Ban, I.; Nonoyama, A.; Sumi, K.; Kuang, C.; Hosoya, T.; Tsukada, H.; Suzuki, M. *Chem.–Eur. J.* **2009**, *15*, 4165–4171. doi:10.1002/chem.200801974
45. Beare, N. A.; Hartwig, J. F. *J. Org. Chem.* **2002**, *67*, 541–555. doi:10.1021/jo016226h
46. Guo, Y.; Twamley, B.; Shreeve, J. M. *Org. Biol. Chem.* **2009**, *7*, 1716–1722. doi:10.1039/b900311h
47. Guo, C.; Wang, R.-W.; Guo, Y.; Qing, F.-L. *J. Fluorine Chem.* **2012**, *133*, 86–96. doi:10.1016/j.jfluchem.2011.08.004
48. Guo, C.; Yue, X.; Qing, F.-L. *Synthesis* **2010**, 1837–1844. doi:10.1055/s-0029-1218740
49. Zhao, Y.; Ni, C.; Jiang, F.; Gao, B.; Shen, X.; Hu, J. *ACS Catal.* **2013**, *3*, 631–634. doi:10.1021/cs4000574
50. Tozer, M. J.; Herpin, T. F. *Tetrahedron* **1996**, *52*, 8619–8683. doi:10.1016/0040-4020(96)00311-0
51. Erickson, J. A.; McLoughlin, J. I. *J. Org. Chem.* **1995**, *60*, 1626–1631. doi:10.1021/jo00111a021
52. Aráoz, R.; Anhalt, E.; René, L.; Badet-Denisot, M.-A.; Courvalin, P.; Badet, B. *Biochemistry* **2000**, *39*, 15971–15979. doi:10.1021/bi001408b
53. Hope, H. R.; Heuvelman, D.; Duffin, K.; Smith, C.; Zablocki, J.; Schilling, R.; Hegde, S.; Lee, L.; Witherbee, B.; Baganoff, M.; Bruce, C.; Tall, A. R.; Krul, E.; Glenn, K.; Connolly, D. T. *J. Lipid Res.* **2000**, *41*, 1604–1614.
54. Giornal, F.; Pazenok, S.; Rodefeld, L.; Lui, N.; Vors, J.-P.; Leroux, F. R. *J. Fluorine Chem.* **2013**, *152*, 2–11. doi:10.1016/j.jfluchem.2012.11.008
55. Manteau, B.; Pazenok, S.; Vors, J.-P.; Leroux, F. R. *J. Fluorine Chem.* **2010**, *131*, 140–158. doi:10.1016/j.jfluchem.2009.09.009
56. Leroux, F. R.; Manteau, B.; Vors, J. P.; Pazenok, S. *Beilstein J. Org. Chem.* **2008**, *4*, No. 13. doi:10.3762/bjoc.4.13
57. Fujikawa, K.; Fujioaka, Y.; Kobayashi, A.; Amii, H. *Org. Lett.* **2011**, *13*, 5560–5563. doi:10.1021/ol202289z
58. Uneyama, K.; Mizutani, G.; Maeda, K.; Kato, T. *J. Org. Chem.* **1999**, *64*, 6717–6723. doi:10.1021/jo990571d
59. Amii, H.; Kobayashi, T.; Uneyama, K. *Synthesis* **2000**, 2001–2003. doi:10.1055/s-2000-8718
60. Clavel, P.; Biran, C.; Bordeaux, M.; Roques, N.; Trévin, S. *Tetrahedron Lett.* **2000**, *41*, 8763–8767. doi:10.1016/S0040-4039(00)01509-4
61. He, Z.; Luo, T.; Hu, M.; Cao, Y.; Hu, J. *Angew. Chem., Int. Ed.* **2012**, *51*, 3944–3947. doi:10.1002/anie.201200140
62. Li, Z.; Cui, Z.; Liu, Z.-Q. *Org. Lett.* **2013**, *15*, 406–409. doi:10.1021/ol3034059
63. Studer, A. *Angew. Chem., Int. Ed.* **2012**, *51*, 8950–8958. doi:10.1002/anie.201202624
64. Liu, T.; Shen, Q. *Eur. J. Org. Chem.* **2012**, 6679–6687. doi:10.1002/ejoc.201200648
65. Samant, B. S.; Kabalka, G. W. *Chem. Commun.* **2011**, *47*, 7236–7238. doi:10.1039/c1cc12098k
66. Cho, E. J.; Buchwald, S. L. *Org. Lett.* **2011**, *13*, 6552–6555. doi:10.1021/ol202885w
67. Wang, X.; Truesdale, L.; Yu, J.-Q. *J. Am. Chem. Soc.* **2010**, *132*, 3648–3649. doi:10.1021/ja909522s
68. Zhang, X.-G.; Dai, H.-X.; Wasa, M.; Yu, J.-Q. *J. Am. Chem. Soc.* **2012**, *134*, 11948–11951. doi:10.1021/ja305259n
69. Zhang, L.-S.; Chen, K.; Chen, G.; Li, B.-J.; Luo, S.; Guo, Q.-Y.; Wei, J.-B.; Shi, Z.-J. *Org. Lett.* **2013**, *15*, 10–13. doi:10.1021/ol302814x

70. Loy, R. N.; Sanford, M. S. *Org. Lett.* **2011**, *13*, 2548–2551. doi:10.1021/ol200628n
71. Dudkina, Y. B.; Mikhaylov, D. Y.; Gryaznova, T. V.; Sinyashin, O. G.; Vivic, D. A.; Budnikova, Y. H. *Eur. J. Org. Chem.* **2012**, 2114–2117. doi:10.1002/ejoc.201200050
72. Mu, X.; Chen, S.; Zhen, X.; Liu, G. *Chem.–Eur. J.* **2011**, *17*, 6039–6042. doi:10.1002/chem.201100283
73. Weng, Z.; Lee, R.; Jia, W.; Yuan, Y.; Wang, W.; Feng, X.; Huang, K.-W. *Organometallics* **2011**, *30*, 3229–3232. doi:10.1021/om200204y
74. Knauber, T.; Arian, F.; Rösenthaler, G.-V.; Gooßen, L. J. *Chem.–Eur. J.* **2011**, *17*, 2689–2697. doi:10.1002/chem.201002749
75. Langlois, B. R.; Billard, T.; Roussel, S. *J. Fluorine Chem.* **2005**, *126*, 173–179. doi:10.1016/j.jfluchem.2004.11.007
76. Kondo, H.; Oishi, M.; Fujikawa, K.; Amii, H. *Adv. Synth. Catal.* **2011**, *353*, 1247–1252. doi:10.1002/adsc.201000825
77. Billard, T.; Langlois, B. R.; Blond, G. *Tetrahedron Lett.* **2000**, *41*, 8777–8780. doi:10.1016/S0040-4039(00)01552-5
78. Matsui, K.; Tobita, E.; Ando, M.; Kondo, K. *Chem. Lett.* **1981**, *10*, 1719–1720. doi:10.1246/cl.1981.1719
79. Chang, Y.; Cai, C. *J. Fluorine Chem.* **2005**, *126*, 937–940. doi:10.1016/j.jfluchem.2005.04.012
80. Li, Y.; Chen, T.; Wang, H.; Zhang, R.; Jin, K.; Wang, X.; Duan, C. *Synlett* **2011**, 1713–1716. doi:10.1055/s-0030-1260930
81. Schareina, T.; Wu, X.-F.; Zapf, A.; Cotté, A.; Gotta, M.; Beller, M. *Top. Catal.* **2012**, *55*, 426–431. doi:10.1007/s11244-012-9824-0
82. Shimizu, R.; Egami, H.; Nagi, T.; Chae, J.; Hamashima, Y.; Sodeoka, M. *Tetrahedron Lett.* **2010**, *51*, 5947–5949. doi:10.1016/j.tetlet.2010.09.027
83. Egami, H.; Shimizu, R.; Sodeoka, M. *Tetrahedron Lett.* **2012**, *53*, 5503–5506. doi:10.1016/j.tetlet.2012.07.134
84. Cai, S.; Chen, C.; Sun, Z.; Xi, C. *Chem. Commun.* **2013**, *49*, 4552–4554. doi:10.1039/c3cc41331d
85. Pair, E.; Monteiro, N.; Bouyssi, D.; Baudoin, O. *Angew. Chem., Int. Ed.* **2013**, *52*, 5346–5349. doi:10.1002/anie.201300782
86. Ilchenko, N. O.; Janson, P. G.; Szabó, K. J. *Chem. Commun.* **2013**, *49*, 6614–6616. doi:10.1039/c3cc43357a
87. Wang, X.; Ye, Y.; Ji, G.; Xu, Y.; Zhang, S.; Feng, J.; Zhang, Y.; Wang, J. *Org. Lett.* **2013**, *15*, 3730–3733. doi:10.1021/ol4016095
88. Langlois, B. R.; Laurent, E.; Roidot, N. *Tetrahedron Lett.* **1991**, *32*, 7525–7528. doi:10.1016/0040-4039(91)80524-A
89. Ji, Y.; Brueckl, T.; Baxter, R. D.; Fujiwara, Y.; Seiple, I. B.; Su, S.; Blackmond, D. G.; Baran, P. S. *Proc. Natl. Acad. Sci. U. S. A.* **2011**, *108*, 14411–14415. doi:10.1073/pnas.1109059108
90. Bravo, A.; Bjørsvik, H.-R.; Fontana, F.; Liguori, L.; Mele, A.; Minisci, F. *J. Org. Chem.* **1997**, *62*, 7128–7136. doi:10.1021/jo970302s
91. Chu, L.; Qing, F.-L. *J. Am. Chem. Soc.* **2012**, *134*, 1298–1304. doi:10.1021/ja209992w
92. Jiang, X.; Chu, L.; Qing, F.-L. *J. Org. Chem.* **2012**, *77*, 1251–1257. doi:10.1021/jo202566h
93. Xu, J.; Luo, D.-F.; Xiao, B.; Liu, Z.-J.; Gong, T.-J.; Fu, Y.; Liu, L. *Chem. Commun.* **2011**, *47*, 4300–4302. doi:10.1039/c1cc10359h
94. Liu, T.; Shen, Q. *Org. Lett.* **2011**, *13*, 2342–2345. doi:10.1021/ol2005903
95. Huang, Y.; Fang, X.; Lin, X.; Li, H.; He, W.; Huang, K.-W.; Yuan, Y.; Weng, Z. *Tetrahedron* **2012**, *68*, 9949–9953. doi:10.1016/j.tet.2012.09.083
96. Ye, Y.; Sanford, M. S. *J. Am. Chem. Soc.* **2012**, *134*, 9034–9037. doi:10.1021/ja301553c
97. Li, Y.; Wu, L.; Neumann, H.; Beller, M. *Chem. Commun.* **2013**, *49*, 2628–2630. doi:10.1039/c2cc36554e
98. Kamigata, N.; Fukushima, T.; Yoshida, M. *J. Chem. Soc., Chem. Commun.* **1989**, 1559–1560. doi:10.1039/C39890001559
99. Kamigata, N.; Fukushima, T.; Yoshida, M. *Chem. Lett.* **1990**, *19*, 649–650. doi:10.1246/cl.1990.649
100. Kamigata, N.; Fukushima, T.; Terakawa, Y.; Yoshida, M.; Sawada, H. *J. Chem. Soc., Perkin Trans. 1* **1991**, 627–633. doi:10.1039/P19910000627
101. Kamigata, N.; Ohtsuka, T.; Fukushima, T.; Yoshida, M.; Shimizu, T. *J. Chem. Soc., Perkin Trans. 1* **1994**, 1339–1346. doi:10.1039/P19940001339
102. Kamigata, N.; Ohtsuka, T.; Shimizu, T. *Phosphorus, Sulfur Silicon Relat. Elem.* **1994**, *95*, 491–492.
103. Kamigata, N.; Ohtsuka, T.; Shimizu, T. *Sulfur Lett.* **1994**, *17*, 69–75.
104. Kamigata, N.; Ohtsuka, T.; Yoshida, M.; Shimizu, T. *Synth. Commun.* **1994**, *24*, 2049–2055. doi:10.1080/00397919408010214
105. Nagib, D. A.; MacMillan, D. W. C. *Nature* **2011**, *480*, 224–228. doi:10.1038/nature10647
106. Iqbal, N.; Choi, S.; Kim, E.; Cho, E. J. *J. Org. Chem.* **2012**, *77*, 11383–11387. doi:10.1021/jo3022346
107. Iqbal, N.; Choi, S.; Ko, E.; Cho, E. J. *Tetrahedron Lett.* **2012**, *53*, 2005–2008. doi:10.1016/j.tetlet.2012.02.032
108. Imhof, S.; Randl, S.; Blechert, S. *Chem. Commun.* **2001**, 1692–1693. doi:10.1039/b105031c
109. Zhou, Q.-L.; Huang, Y.-Z. *J. Fluorine Chem.* **1988**, *39*, 87–98. doi:10.1016/S0022-1139(00)82739-6
110. Zhou, Q.-L.; Huang, Y.-Z. *J. Fluorine Chem.* **1989**, *43*, 385–392. doi:10.1016/S0022-1139(00)82725-6
111. Huang, X.-T.; Chen, Q.-Y. *J. Org. Chem.* **2001**, *66*, 4651–4656. doi:10.1021/jo010178j
112. Baciocchi, E.; Muraglia, E. *Tetrahedron Lett.* **1993**, *34*, 3799–3800. doi:10.1016/S0040-4039(00)79233-1
113. Mejia, E.; Togni, A. *ACS Catal.* **2012**, *2*, 521–527. doi:10.1021/cs300089y
114. Uraguchi, D.; Yamamoto, K.; Ohtsuka, Y.; Tokuhisa, K.; Yamakawa, T. *Appl. Catal., A* **2008**, *342*, 137–143. doi:10.1016/j.apcata.2008.03.009
115. Kino, T.; Nagase, Y.; Ohtsuka, Y.; Yamamoto, K.; Uraguchi, D.; Tokuhisa, K.; Yamakawa, T. *J. Fluorine Chem.* **2010**, *131*, 98–105. doi:10.1016/j.jfluchem.2009.09.007
116. Parsons, A. T.; Senecal, T. D.; Buchwald, S. L. *Angew. Chem., Int. Ed.* **2012**, *51*, 2947–2950. doi:10.1002/anie.201108267
117. Mizuta, S.; Stenhagen, I. S. R.; O'Duill, M.; Wolstenhulme, J.; Kirjavainen, A. K.; Forsback, S. J.; Tredwell, M.; Sandford, G.; Moore, P. R.; Huiban, M.; Luthra, S. K.; Passchier, J.; Solin, O.; Gouverneur, V. *Org. Lett.* **2013**, *15*, 2648–2651. doi:10.1021/ol4009377
118. Kispert, L. D.; Liu, H.; Pittman, C. U. *J. Am. Chem. Soc.* **1973**, *95*, 1657–1659. doi:10.1021/ja00786a049
119. Yu, D.; Gang, Z.; Weiyuan, H. *Tetrahedron Lett.* **1993**, *34*, 1321–1322. doi:10.1016/S0040-4039(00)91785-4
120. Iizuka, M.; Fukushima, S.; Yoshida, M. *Chem. Lett.* **2007**, *36*, 1042–1043. doi:10.1246/cl.2007.1042
121. Iizuka, M.; Yoshida, M. *J. Fluorine Chem.* **2009**, *130*, 926–932. doi:10.1016/j.jfluchem.2009.07.010
122. Wiehn, M. S.; Vinogradova, E. V.; Togni, A. *J. Fluorine Chem.* **2010**, *131*, 951–957. doi:10.1016/j.jfluchem.2010.06.020

123. Schmidt, B. M.; Seki, S.; Topolinski, B.; Ohkubo, K.; Fukuzumi, S.; Sakurai, H.; Lentz, D. *Angew. Chem., Int. Ed.* **2012**, *51*, 11385–11388. doi:10.1002/anie.201205757
124. Boiko, V. N. *Beilstein J. Org. Chem.* **2010**, *6*, 880–921. doi:10.3762/bjoc.6.88
125. Zhang, C.-P.; Vivic, D. A. *J. Am. Chem. Soc.* **2012**, *134*, 183–185. doi:10.1021/ja210364r
126. Hansch, C.; Leo, A.; Taft, R. W. *Chem. Rev.* **1991**, *91*, 165–195. doi:10.1021/cr00002a004
127. Hansch, C.; Leo, A. *Substituent Constants for Correlation Analysis in Chemistry and Biology*; John Wiley and Sons, 1979.
128. Leo, A.; Jow, P. Y. C.; Silipo, C.; Hansch, C. *J. Med. Chem.* **1975**, *18*, 865–868. doi:10.1021/jm00243a001
129. Hansch, C.; Leo, A.; Unger, S. H.; Kim, K. H.; Nikaitani, D.; Lien, E. J. *J. Med. Chem.* **1973**, *16*, 1207–1216. doi:10.1021/jm00269a003
130. Manteau, B.; Genix, P.; Brelot, L.; Vors, J.-P.; Pazenok, S.; Giornal, F.; Leuenberger, C.; Leroux, F. R. *Eur. J. Org. Chem.* **2010**, 6043–6066. doi:10.1002/ejoc.201000958
131. Tlili, A.; Billard, T. *Angew. Chem., Int. Ed.* **2013**, *52*, 6818–6819. doi:10.1002/anie.201301438
132. Ferry, A.; Billard, T.; Bacqué, E.; Langlois, B. R. *J. Fluorine Chem.* **2012**, *134*, 160–163. doi:10.1016/j.jfluchem.2011.02.005
133. Baert, F.; Colomb, J.; Billard, T. *Angew. Chem., Int. Ed.* **2012**, *51*, 10382–10385. doi:10.1002/anie.201205156
134. Teverovskiy, G.; Surry, D. S.; Buchwald, S. L. *Angew. Chem., Int. Ed.* **2011**, *50*, 7312–7314. doi:10.1002/anie.201102543
135. Chen, C.; Xie, Y.; Chu, L.; Wang, R.-W.; Zhang, X.; Qing, F.-L. *Angew. Chem., Int. Ed.* **2012**, *51*, 2492–2495. doi:10.1002/anie.201108663
136. Tran, L. D.; Popov, I.; Daugulis, O. *J. Am. Chem. Soc.* **2012**, *134*, 18237–18240. doi:10.1021/ja3092278
137. Shao, X.; Wang, X.; Yang, T.; Lu, L.; Shen, Q. *Angew. Chem., Int. Ed.* **2013**, *52*, 3457–3460. doi:10.1002/anie.201209817
138. Yang, Y.-D.; Azuma, A.; Tokunaga, E.; Yamasaki, M.; Shiro, M.; Shibata, N. *J. Am. Chem. Soc.* **2013**, *135*, 8782–8785. doi:10.1021/ja402455f

License and Terms

This is an Open Access article under the terms of the Creative Commons Attribution License (<http://creativecommons.org/licenses/by/2.0>), which permits unrestricted use, distribution, and reproduction in any medium, provided the original work is properly cited.

The license is subject to the *Beilstein Journal of Organic Chemistry* terms and conditions: (<http://www.beilstein-journals.org/bjoc>)

The definitive version of this article is the electronic one which can be found at:
doi:10.3762/bjoc.9.287

Reaction of 2,2,4,4-tetrakis(trifluoromethyl)-1,3-dithiethane with *N*-vinyl compounds

Viacheslav A. Petrov*^{1,§} and Will Marshall²

Letter

Open Access

Address:

¹DuPont Central Research and Development, Experimental Station, PO Box 80500, Wilmington DE 19880-0500, USA and ²DuPont Corporate Center for Analytical Sciences, Experimental Station, PO Box 80500, Wilmington DE 19880-0500, USA

Email:

Viacheslav A. Petrov* - viacheslav.a.petrov@usa.dupont.com

* Corresponding author

§ Publication No 2013-877

Keywords:

1-(hexafluoroisopropyl)-3-vinyl-1,3-dihydro-2*H*-imidazole-2-thione; 2,2,4,4-tetrakis(trifluoromethyl)-1,3-dithiethane; 4-amino-2,2-bis(trifluoromethyl)thietanes; organo-fluorine

Beilstein J. Org. Chem. **2013**, *9*, 2615–2619.

doi:10.3762/bjoc.9.295

Received: 04 September 2013

Accepted: 30 October 2013

Published: 21 November 2013

This article is part of the Thematic Series "Organo-fluorine chemistry III".

Guest Editor: D. O'Hagan

© 2013 Petrov and Marshall; licensee Beilstein-Institut.

License and terms: see end of document.

Abstract

The reaction of hexafluorothioacetone dimer (2,2,4,4-tetrakis(trifluoromethyl)-1,3-dithiethane, **1**) with vinylamides leads to the rapid formation of [2 + 2] cycloadducts: 4-amino-2,2-bis(trifluoromethyl)thietanes. The reaction proceeds in polar solvents (DMF, DMSO) in the absence of a catalyst at elevated temperature producing the corresponding cycloadducts in 47–86% yield. The reaction of *N*-vinylimidazole unexpectedly led to the formation of the corresponding 1-(hexafluoroisopropyl)-3-vinyl-1,3-dihydro-2*H*-imidazole-2-thione (**5**). The structure of this compound, along with the structures of two new thietanes was confirmed by single crystal X-ray diffraction.

Introduction

Hexafluorothioacetone (HFTA) and hexafluorothioacetone dimer (2,2,4,4-tetrakis(trifluoromethyl)-1,3-dithiethane (**1**)) were shown to react with a wide variety of electron-rich olefins and dienes, producing the corresponding cycloadducts. Reported examples include the corresponding thietanes, derived from the reaction of HFTA with vinyl ethers, vinyl sulfides, cyclic dienes and styrenes [1,2], fluoride anion-catalyzed reactions of compound **1** with vinyl ethers [1,3,4], vinyl sulfides [3], ketene dimethylacetal [5], styrenes [6,7], cyclic dienes [8] and quadricyclane [9]. At this point, no data for the reaction of HFTA or HFTA dimer with vinylamines can be found in the literature, despite the fact that (CF₃)₂C=C=S (which exhibits a reactivity

very similar to the reactivity of HFTA) was reported to react with *N*-vinylcarbazole to give a [2 + 2] cycloadduct [10]. In this paper we report the synthesis of 2,2-bis(trifluoromethyl)-4-amino-substituted thietanes by a reaction of **1** with selected vinylated amino compounds.

Results and Discussion

It was found that *N*-vinylamides **2a,b** react with **1** in the absence of a catalyst in polar solvents to produce the corresponding thietanes **3a,b** in moderate yield (Scheme 1). The reaction can be carried out at either ambient or elevated temperature (see Table 1).

Table 1: Reaction conditions, yields, melting/boiling points and MS data for compounds **3a–e** and **5**.

Compound	Method ^a	Temp. (°C)/Time (h), Solvent	Yield (%)	Mp (°C), (bp °C/mmHg)	MS (<i>m/z</i>)
3a	A	25/72, DMF	47	orange oil ^b	253 (M ⁺ , C ₆ H ₅ F ₆ NOS ⁺)
	A	25/16, DMSO	75 ^c		
3b	A	70/14, DMF	48	93–94	281 (M ⁺ , C ₈ H ₉ F ₆ NOS ⁺)
	A	70/16, neat ^d	69		
	B	25–50/12, DMF	56		
3c	A	70–80/2, DMF	86	81–82	293 (M ⁺ , C ₉ H ₉ F ₆ NOS ⁺)
3d	A	70/24, DMF	55–86	80–81	321 (M ⁺ , C ₁₁ H ₁₃ F ₆ NOS ⁺)
3e	A	70/2, DMF	55	103–103.5	375 (C ₁₇ H ₁₁ F ₆ NS ⁺)
	B	25/16, DMF	60		
5	A	25/48, DMF	50	40–41 (74/2)	276 (M ⁺ , C ₈ H ₆ F ₆ N ₂ S ⁺)
	A	70/2, DMF	48		

^aMethod A: no catalyst; method B: HFP, S_x, DMF, one-pot reaction. ^bPurity 98%, GC–MS, NMR. ^c90% by NMR. ^dThree molar excess of vinylamide was used.

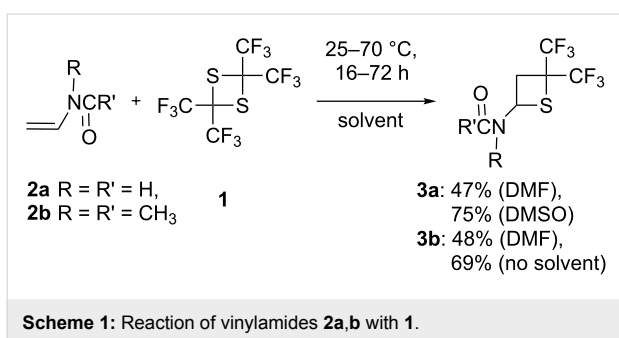

It should be pointed out that in case of compound **2b** the reaction can be performed in an excess of vinylamine as the solvent. The reaction is highly selective (NMR), leading to the exclusive formation of thietanes and fluctuations in the isolated yields of compounds **3a** and **3b** are connected to the isolation protocol (see Experimental). In contrast to the corresponding cycloadducts of vinyl ethers and HFTA (2,2-bis(trifluoromethyl)-4-alkoxythietanes), which are high-boiling liquids [3], thietanes **3a** and **3b** are solids at room temperature. The structure of purified **3b** was established by single crystal X-ray diffraction (Figure 1).

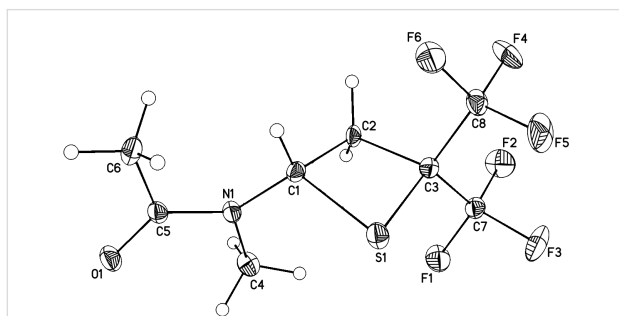
**Figure 1:** Crystal structure of **3b** with thermal ellipsoids drawn at the 30% probability level.

Interestingly, the ¹⁹F and ¹H NMR spectra of both compounds **3a** and **3b** show two sets of signals, probably being a result of restricted rotation around the C–N bond in the amide fragment, similar to restricted rotation of –N(CH₃)₂ in dimethylformamide. Cyclic lactams **2c,d** bearing a vinyl group at the nitrogen also undergo reaction with **1** producing the corresponding thietanes **3c,d** (Scheme 2).

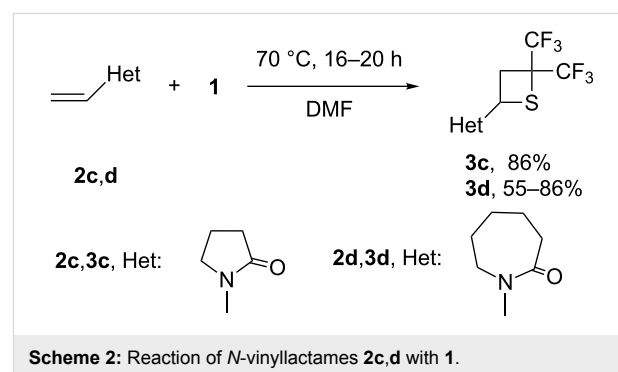

It should be pointed out that in sharp contrast to compounds **3a,b**, NMR spectra of **3c** and **3d** exhibit only one set of signals, which might be indicative of a significantly lower rotation barrier around the C–N bond in these two materials. The structures of both **3c** and **3d** were established by single crystal X-ray diffraction. Compounds **3b** and **3e** were also prepared in 56–60% yield by using a one-step process in which dimer **1** was generated by the reaction of hexafluoropropene (HFP) with sulfur in the presence of CsF as catalyst, followed by the addition of vinyl compounds **2b** or **2e** without the isolation of dimer **1**.

N-vinylcarbazole (**2e**) was found to have the highest reactivity towards **1**. Indeed, when the mixture of **2e** and **1** in DMF was heated at 70 °C, no starting carbazole was found in the reaction

mixture after 2 hours (NMR). This reaction led to the selective formation of thietane **3e**, isolated in 67% yield (Scheme 3). The structure of **3e** was established by single crystal X-ray diffraction (Figure 2).

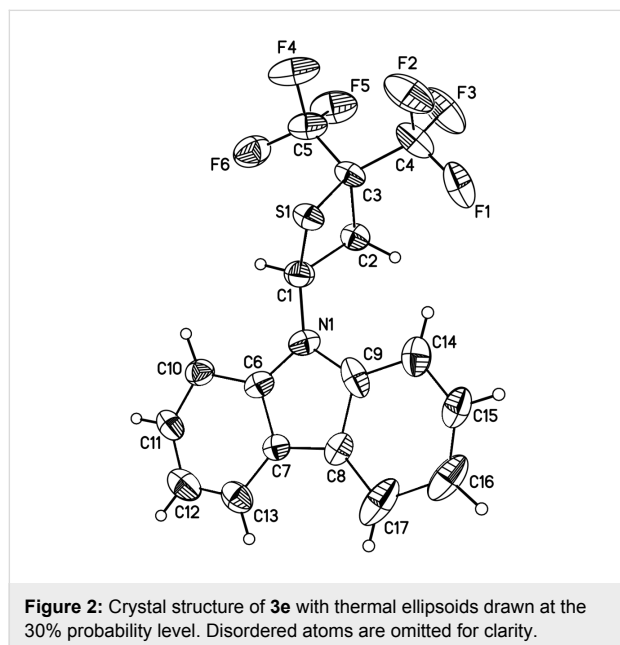
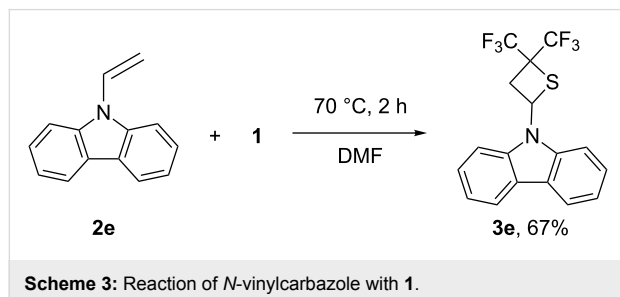

Interestingly, the ^{19}F and ^1H NMR spectra of **3e** showed only one set of signals, despite the fact that in the corresponding cyclopropane (prepared by the reaction of compound **3e** with PBu_3), restricted rotation around the C–N bond was observed [11].

N-vinylimidazole (**4**) was found to have a different reactivity profile. The reaction of **4** with **1** (25 °C, 48 h) unexpectedly led to the formation of thione **5** (rather than the corresponding thietane) as a sole product (NMR, Scheme 4). Thione **5** was isolated in 48–50% yield and its structure was established by single crystal X-ray diffraction (Figure 3).

At elevated temperature, the reaction of **4** with **1** was significantly faster and it was completed after 2 h at 70 °C in DMF. On the other hand, *N*-vinyl-1,3,4-triazole was found to be inert

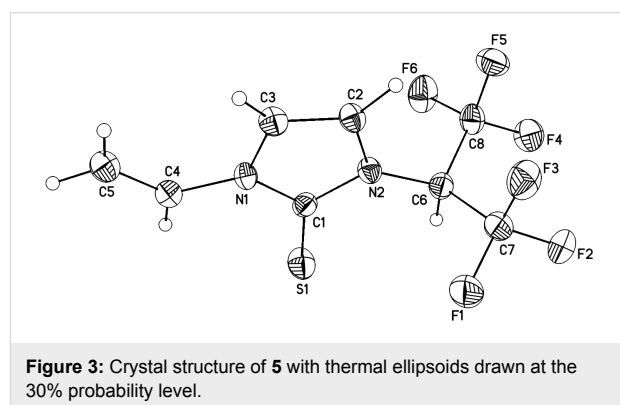
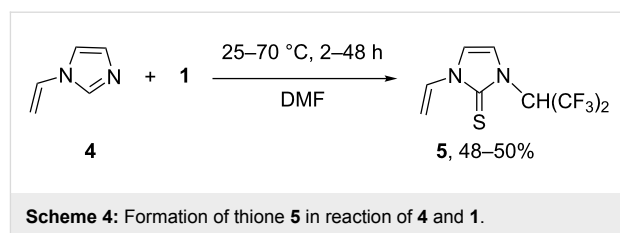

towards dimer **1** and even after prolonged heating (70 °C, 48 h, DMF) only starting materials were observed in the reaction mixture (NMR).

The mechanistic aspect of thione **5** formation is not clear at this point. The formation of the corresponding thiones in the reaction of **1** with *N*-alkylimidazoles was found to be common in nature.

Experimental

^1H NMR and ^{19}F NMR spectra were recorded on a Bruker DRX-500 (499.87 MHz) instrument by using CFCl_3 or TMS as an internal standard. CDCl_3 was used as a lock solvent. GC and GC–MS analyses were carried out on a HP-6890 instrument by using an HP FFAP capillary column and either TCD (GC) or mass-selective (GC–MS) detectors, respectively. Dry DMF (water <100 ppm), vinylamines **2a–e** and **4** (Aldrich), sulfur (Alfa Aesar, sublimed, 99.5%, 100 mesh) and hexafluoropropene (DuPont) were purchased and used without further purification. CsF (Aldrich, 99%) was dried at 100–120 °C under dynamic vacuum and stored and handled inside of glove box.

Compound **1** (liquid, purity 93–98%) was prepared by using modified literature procedure reported in [12] and was used without further purification.

Due to the high ratio of sulfur to fluorine, the elemental analysis of new materials was not attempted. The purity of all new compounds established by GC and NMR spectroscopy was at least 98%.

Crystallography

X-ray data for **3b**, **3e** and **5a** were collected at $-100\text{ }^{\circ}\text{C}$ by using a Bruker 1K CCD system equipped with a sealed tube molybdenum source and a graphite monochromator. The structures were solved and refined with the Shelxtl [13] software package, refinement by full-matrix least squares on F^2 , scattering factors from Int. Tab. Vol. C Tables 4.2.6.8 and 6.1.1.4. Crystallographic data (excluding structure factors) for the structures in this paper have been deposited with the Cambridge Crystallographic Data Centre as supplementary publication nos. CCDC #956557-956559. Copies of the data can be obtained, free of charge, on application to CCDC, 12 Union Road, Cambridge CB2 1EZ, UK, (fax: +44 1223 336033 or e-mail: deposit@ccdc.cam.ac.uk).

Reaction of **1** with **2a–e** and **4** (typical procedure)

Method A: To a solution of the corresponding vinyl compound (0.01–0.02 mol) in 15 mL of solvent was added 0.005–0.01 mol of dimer **1**. The reaction mixture was agitated for 2–72 h at either ambient or elevated temperature. The reaction mixture was diluted by water (300 mL), extracted with hexane ($3 \times 50\text{ mL}$). Combined organic layers were washed by water ($3 \times 200\text{ mL}$) and dried over MgSO_4 . The solvent was removed

under reduced pressure and the residue was purified either by crystallization from hexane or distillation (compound **5**).

Method B: Inside a glove box a dry three-necked round-bottomed flask was charged with 0.5–1.0 g of dry CsF . The flask was taken out and equipped with dry-ice condenser, thermocouple, gas inlet tube and 100 mL of dry DMF was added by using a syringe, followed by the addition of 6.4 g (0.2 mol) of sublimed sulfur. The reaction mixture was agitated for 15–20 min, while the temperature was raised up to $35\text{--}40\text{ }^{\circ}\text{C}$. This process was accompanied by the development of a dark blue–brown color of the reaction mixture. Hexafluoropropene 32 g (0.21 mol) was added as a gas to the reaction mixture, and the temperature usually rose to $65\text{--}70\text{ }^{\circ}\text{C}$ during the addition and at the end all sulfur went into solution. The reaction mixture was cooled to an ambient temperature followed by the addition of the corresponding *N*-vinyl compound, and the reaction mixture was agitated for 12–16 h. Afterwards the mixture was diluted with water (500 mL) and extracted with hexane ($3 \times 100\text{ mL}$). The combined organic layers were washed with water ($3 \times 200\text{ mL}$) and dried over MgSO_4 . The solvent was removed under reduced pressure, and the residue was purified either by crystallization from hexane or distillation (see Table 1 for conditions and yields and Table 2 for NMR data).

Table 2: ^1H , ^{19}F , ^{13}C NMR data for compounds **3a–e** and **5**.

Entry	Compound	^1H NMR ^a (δ , ppm, J, Hz)	^{19}F NMR ^a (δ , ppm, J, Hz)	^{13}C NMR ^{a,b} (δ , ppm, J, Hz)
1	3a ^c	Major: 3.03 (1H, m), 3.55 (1H, m), 5.82 (1H, dd, 7.8), 6.40 (1H, br.s), 8.18 (1H, s) Minor: 3.21 (1H, dd), 3.51 (1H, dd), 5.35 (1H, m), 6.39 (br. s), 8.13 (1H, d, 11.0)	Major: -73.80 (s) ^d Minor: -73.65 (m), -73.59 (m)	Major: 38.4, 41.2, 46.6 (sept., 32.0), 123.3 (q, 278.0), 124.2 (q, 276.0), 161.3
2	3b ^e	Major: 3.13 (3H, s), 2.19 (3H, s), 3.15 (1H, m), 3.32 (1H, m), 6.67 (1H, t, 7.8) Minor: 2.17 (s), 3.59 (s), 5.89 (m)	Major: -72.73 (3F, q, 9.6), -73.78 (3F, q, 9.6) Minor: -72.66 (br.s), -73.78	Major: 22.51, 29.6, 34.5, 45.8 (sept., 31.8), 47.5, 123.5 (q, 280), 124.4 (q, 284), 171.8
3	3c	2.11 (2H, sept, 7.0), 2.44 (2H, m), 3.25 (1H, dd), 3.37 (1H, dd), 3.60 (1H, m), 3.85 (1H, m), 6.16 (1H, t, 8.0)	-73.09 (3F, q, 9.6), -73.91 (3F, q, 9.6)	17.5, 31.3, 34.5, 41.9, 45.2, 45.8 (sept, 33.1), 123.4 (q, 279), 124.5 (q, 279), 175.6
4	3d	1.68 (3H, m), 1.76 (3H, m), 2.56 (1H, t, 8.1), 3.21 (2H, m), 3.70 (2H, m), 6.63 (1H, t, 8.1)	-72.63 (3F, q, 10.3), -73.70 (3F, q, 10.3)	23.23, 29.5, 29.6, 35.7, 37.4, 42.7, 46.0 (sept., 31.9), 47.4, 123.4 (q, 277), 124.6 (q, 279), 176.5
5	3e	3.45 (1H, m), 4.50 (1H, m), 6.75 (1H, t), 7.33 (2H, m), 7.50 (2H, m), 7.54 (2H, m), 7.92 (2H, m)	-70.81 (3F, q, 8.0), -73.22 (3F, q, 8.0)	38.2, 46.9 (sept, 32.0), 48.9, 110.6 (q, 1.5), 120.6, 121.2, 123.5 (q, 281), 124.5, 126.3, 130.3
6	5	5.06 (1H, dd, 8.8, 2.0), 5.25 (1H, dd, 16.3, 2.5), 6.72 (sept, 7.1), 6.99 (1H,s), 7.06 (1H, d, 2.5), 7.50 (1H, dd 16.3, 8.8)	-69.19 (d, 7.1)	

^aIn CDCl_3 as lock solvent. ^b $^1\text{H}/^{13}\text{C}$ NMR spectra. ^cTwo partially overlapped sets of signals, ratio 5:1. ^d ^{19}F NMR of **3a** in the presence of DMF (CDCl_3): Major: -73.58 (3F, q, 10.1 Hz), -73.94 (3F, q, 10.1 Hz) ppm; minor: -73.24 (3F, q, 10.1 Hz), -73.75 (3F, q, 10.1 Hz) ppm. ^eTwo partially overlapped sets of signals, ratio 3:1.

Acknowledgements

The authors are grateful to Dr. Chris Junk for helpful discussions, the reviewers for valuable suggestions, and Timothy Bentz for technical support.

References

1. Middleton, W. J. *J. Org. Chem.* **1965**, *30*, 1390–1394. doi:10.1021/jo01016a010
2. Middleton, W. J. *J. Org. Chem.* **1965**, *30*, 1395–1398. doi:10.1021/jo01016a011
3. Petrov, V. A.; Marshall, W. J. *Fluorine Chem.* **2010**, *131*, 1144–1155. doi:10.1016/j.jfluchem.2010.06.011
4. Kitazume, T.; Otaka, T.; Takei, R.; Ishikawa, N. *Bull. Chem. Soc. Jpn.* **1976**, *49*, 2491–2494. doi:10.1246/bcsj.49.2491
5. Petrov, V. A.; Marshall, W. J. *Fluorine Chem.* **2012**, *143*, 220–225. doi:10.1016/j.jfluchem.2012.06.031
6. Kitazume, T.; Ishikawa, N. *Chem. Lett.* **1973**, *2*, 267–268. doi:10.1246/cl.1973.267
7. Petrov, V. A.; Marshall, W. J. *Fluorine Chem.* **2011**, *132*, 783–791. doi:10.1016/j.jfluchem.2011.03.024
8. Petrov, V.; Marshall, W. J. *Fluorine Chem.* **2007**, *128*, 729–735. doi:10.1016/j.jfluchem.2007.02.009
9. Petrov, V. A.; Krespan, C. G.; Marshall, W. J. *Fluorine Chem.* **2005**, *126*, 1332–1341. doi:10.1016/j.jfluchem.2005.07.001
10. Raasch, M. S. *J. Org. Chem.* **1970**, *35*, 3470–3483. doi:10.1021/jo00835a064
11. Petrov, V. A.; Marshall, W. J. *Fluorine Chem.* **2012**, *133*, 61–66. doi:10.1016/j.jfluchem.2011.06.022
12. Petrov, V. A.; Marshall, W. J. *Fluorine Chem.* **2009**, *130*, 780–787. doi:10.1016/j.jfluchem.2009.06.011
13. *SHELXTL Software Suite*, Version 6.0; Bruker Axes Corp.: Madison, WI, 1996.

License and Terms

This is an Open Access article under the terms of the Creative Commons Attribution License (<http://creativecommons.org/licenses/by/2.0>), which permits unrestricted use, distribution, and reproduction in any medium, provided the original work is properly cited.

The license is subject to the *Beilstein Journal of Organic Chemistry* terms and conditions: (<http://www.beilstein-journals.org/bjoc>)

The definitive version of this article is the electronic one which can be found at:
[doi:10.3762/bjoc.9.295](https://doi.org/10.3762/bjoc.9.295)

Copper-catalyzed trifluoromethylation of alkenes with an electrophilic trifluoromethylating reagent

Xiao-Ping Wang^{1,2}, Jin-Hong Lin¹, Cheng-Pan Zhang¹, Ji-Chang Xiao^{*1}
and Xing Zheng²

Letter

Open Access

Address:

¹Key Laboratory of Organofluorine Chemistry, Shanghai Institute of Organic Chemistry, Chinese Academy of Sciences, 345 Lingling Road, Shanghai 200032, China and ²Institute of Pharmacy and Pharmacology, University of South China, Hengyang, Hunan 421001, China

Email:

Ji-Chang Xiao^{*} - jchxiao@sioc.ac.cn

* Corresponding author

Keywords:

alkenes; catalysis; copper; electrophilic trifluoromethylating reagent; trifluoromethylation

Beilstein J. Org. Chem. **2013**, *9*, 2635–2640.

doi:10.3762/bjoc.9.299

Received: 18 July 2013

Accepted: 06 November 2013

Published: 25 November 2013

This article is part of the Thematic Series "Organo-fluorine chemistry III".

Guest Editor: D. O'Hagan

© 2013 Wang et al; licensee Beilstein-Institut.

License and terms: see end of document.

Abstract

An efficient method for the copper-catalyzed trifluoromethylation of terminal alkenes with an electrophilic trifluoromethylating reagent has been developed. The reactions proceeded smoothly to give trifluoromethylated alkenes in good to excellent yields. The results provided a versatile approach for the construction of C_{vinyl}-CF₃ bonds without using prefunctionalized substrates.

Introduction

The incorporation of a trifluoromethyl group into pharmaceutically and agrochemically relevant molecules usually enhances their chemical and metabolic stability, lipophilicity and binding selectivity [1-7]. As a result, considerable effort has been directed towards the development of efficient and versatile trifluoromethylation methods [8-16]. The past few years has witnessed the rapid advances in transition metal-promoted trifluoromethylation for the construction of C_{aryl}-CF₃ bonds [17-31]. In contrast, transition metal-mediated trifluoromethylation to form C_{vinyl}-CF₃ bonds has been much less explored. As illustrated in Scheme 1, the strategies developed recently usually require the use of prefunctionalized alkenes, which

could be classified into the following: vinylboronic acids, vinyl borates, vinyl halides, vinyl sulfonates and vinyl carboxylic acids (Scheme 1, reaction 1) [32-38]. Cho and co-workers reported a radical process for the trifluoromethylation of terminal alkenes without using prefunctionalized substrates, but a volatile reagent was used (Scheme 1, reaction 1) [39]. Szabó described trifluoromethyl-benzoyloxylation of alkynes to construct C_{vinyl}-CF₃ bonds (Scheme 2, reaction 2) [40]. As part of our continuing interest in trifluoromethylation reactions [25,41-45], we investigated the copper-catalyzed trifluoromethylation of terminal alkenes with electrophilic trifluoromethylating reagents (Scheme 1, reaction 3).

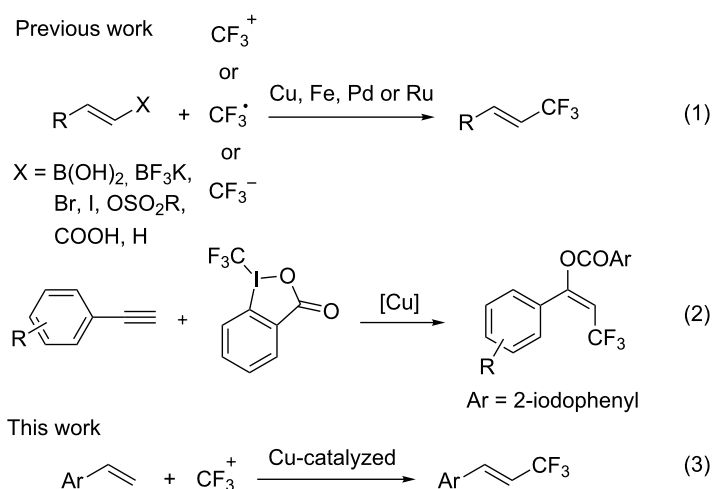

Scheme 1: Construction of the C_{vinyl}-CF₃ bond.

Transition metal-catalyzed trifluoromethylation of terminal alkenes has been reported by several groups. However, these methods focused on the formation of C_{sp³}-CF₃ bonds [46-56]. In copper-catalyzed reactions with electrophilic trifluoromethylating reagents, it was proposed that the transformation might proceed via a radical, electrophilic or Heck-type process (Scheme 2) [47-50]. We reasoned that even if the reaction involved the radical process (path A, Scheme 2), the radical intermediate could still be oxidized to a cation because electrophilic trifluoromethylation reagents can be considered as an oxidant. In the presence of base, both of the cation and Heck-type intermediates should be able to undergo hydrogen elimination to form a C_{vinyl}-CF₃ bond. On the basis of these reports and our hypothesis, we commenced to examine the reaction of aromatic alkenes with electrophilic trifluoromethylation reagents in the presence of copper and base.

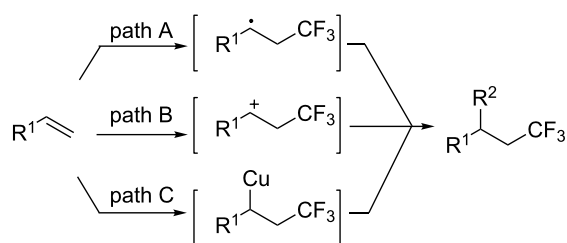

Scheme 2: Proposed reaction paths for the trifluoromethylation of alkenes.

Results and Discussion

Previously, we reported that copper powder or cuprous iodide could promote trifluoromethylation of heteroaromatics, arylboronic acids or terminal alkynes with trifluoromethyl sulfo-

nium salt **I** [25,44,45,57,58]. But the same trifluoromethylation reagent (2 equiv) failed to convert 4-vinylbiphenyl to the expected alkene in reasonable yields in acetonitrile with B₁ (DBU) as the base, even though cuprous iodide gave better results (Table 1, entries 1 and 2). In the presence of cuprous iodide, Umemoto's reagent (**II**) and Togni's reagent (**III**) were found to be more efficient in this transformation (Table 1, entries 3 and 4). ¹⁹F NMR measurements showed that the reaction system turned to be complex and low yield of the desired product was determined when another Togni's reagent (**IV**) was used (Table 1, entry 5). Other cuprous complexes were also studied with the use of Togni's reagent (**III**) (Table 1, entries 6–10). Better result obtained with [(MeCN)₄Cu]PF₆ prompted us to continue to use this copper source (Table 1, entry 10). When B₂ was used instead of B₁, almost no desired product was observed (Table 1, entry 11). That might be because B₂ not only acted as base, but also acted as strongly coordinating ligand, which poisoned the catalyst and shut down the reaction. Other bases (Table 1, entries 12–15), including an inorganic base (Table 1, entry 15), failed to accelerate the desired conversion either. The examination of the solvent effect showed that the solvent is quite important for the reaction (Table 1, entries 16–20). When the reaction was carried out in DMF, the expected product **2a** was obtained in excellent yield (Table 1, entry 16). The yield was decreased dramatically in DMSO (Table 1, entry 17). Almost no reaction took place in polar protic solvent (Table 1, entry 18) and moderate results were achieved in less polar solvents (Table 1, entries 19 and 20). With increasing the amount of Togni's reagent (**III**) in the suitable solvent, DMF, the product was obtained almost in quantitative yield with excellent stereoselectivity (dr >98:2) determined by ¹⁹F NMR (Table 1, entry 21). Decreasing the amount of this reagent resulted in a lower yield (Table 1, entry 22). The

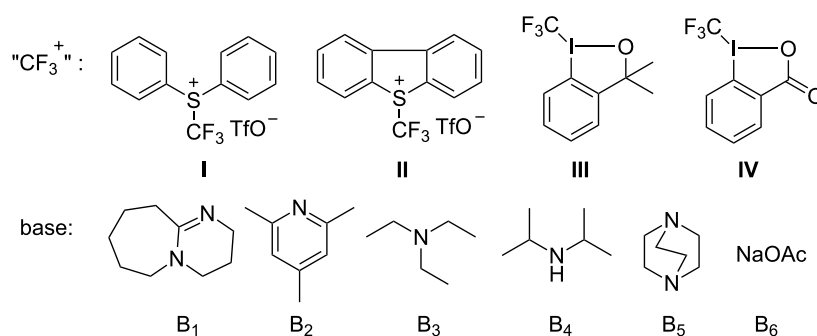
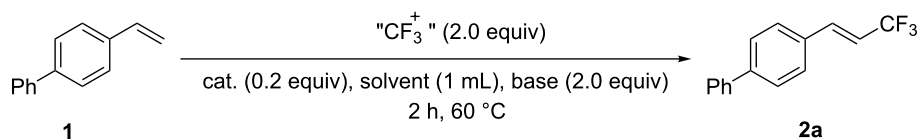
Table 1: Trifluoromethylation of 4-vinylbiphenyl by electrophilic trifluoromethylation reagents.

Entry	Cat.	Base	Solvent	"CF ₃ ⁺ "	Yield (%) ^a
1	Cu	B ₁	CH ₃ CN	I	trace
2	CuI	B ₁	CH ₃ CN	I	30
3	CuI	B ₁	CH ₃ CN	II	56
4	CuI	B ₁	CH ₃ CN	III	60
5	CuI	B ₁	CH ₃ CN	IV	30
6	CuBr	B ₁	CH ₃ CN	III	46
7	CuCl	B ₁	CH ₃ CN	III	36
8	CuTc	B ₁	CH ₃ CN	III	54
9	CuOAc	B ₁	CH ₃ CN	III	41
10	[(MeCN) ₄ Cu]PF ₆	B ₁	CH ₃ CN	III	75
11	[(MeCN) ₄ Cu]PF ₆	B ₂	CH ₃ CN	III	trace
12	[(MeCN) ₄ Cu]PF ₆	B ₃	CH ₃ CN	III	10
13	[(MeCN) ₄ Cu]PF ₆	B ₄	CH ₃ CN	III	trace
14	[(MeCN) ₄ Cu]PF ₆	B ₅	CH ₃ CN	III	10
15	[(MeCN) ₄ Cu]PF ₆	B ₆	CH ₃ CN	III	7
16	[(MeCN) ₄ Cu]PF ₆	B ₁	DMF	III	90
17	[(MeCN) ₄ Cu]PF ₆	B ₁	DMSO	III	57
18	[(MeCN) ₄ Cu]PF ₆	B ₁	CH ₃ OH	III	trace
19	[(MeCN) ₄ Cu]PF ₆	B ₁	THF	III	67
20	[(MeCN) ₄ Cu]PF ₆	B ₁	CHCl ₃	III	75
21 ^b	[(MeCN) ₄ Cu]PF ₆	B ₁	DMF	III	98
22 ^c	[(MeCN) ₄ Cu]PF ₆	B ₁	DMF	III	58
23	–	–	DMF	III	0
24	–	B ₁	DMF	III	0
25	[(MeCN) ₄ Cu]PF ₆	–	DMF	III	10

^aYields determined by ¹⁹F NMR spectroscopy. ^b2.5 equiv of III was used. ^c1.5 equiv of III was used.

absence of catalyst or base led to no reaction or incredibly low yield, which means both of them are crucial for the reaction (Table 1, entries 23–25).

With the optimized reaction conditions in hand (Table 1, entry 21), we then explored the substrate scope of the Cu(I)-catalyzed

trifluoromethylation of terminal alkenes with Togni's reagent. As shown in Figure 1, the reaction could tolerate various functional groups. It is worth mentioning that all of the products were obtained with excellent stereoselectivity (*E/Z* >97/3), determined by ¹⁹F NMR. Substrates with an electron-donating group were converted smoothly into the desired products in

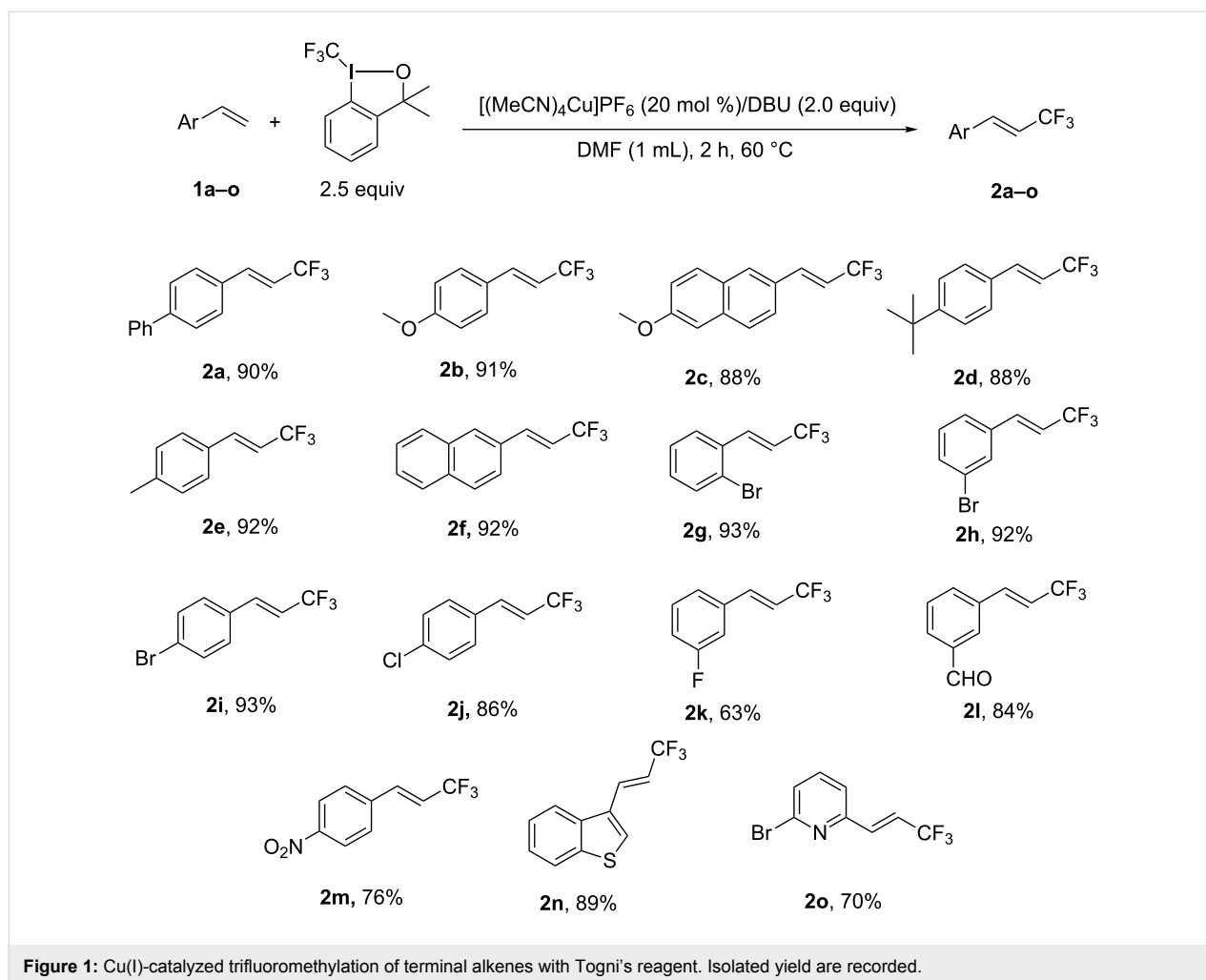

excellent yields (**2a–2f**). Irrespective of the position of the bromine substituent on the aryl ring, the reaction proceeded very well to afford the desired products in excellent yields (**2g–2i**). Stronger electron-withdrawing groups showed some negative effect on the reaction, as exemplified by the poor results of substrates with other halides, carbonyl or nitro groups on the benzene ring (**2j–2m**). Heteroaromatic alkenes were also investigated (**2n** and **2o**). As previously seen, alkene **1n** endowed with an electron-rich heteroaromatic group led to a good result (**2n**) and an electron-deficient substrate resulted in low yield (**2o**).

With regard to the reaction mechanism, it is reasonable to conceive a pathway involving radical species according to previous reports [47–50]. To gain more insight into the mechanism, further evidence was collected. 2,2,6,6-Tetramethyl-1-piperidinyloxy (TEMPO), a well-known radical scavenger, was added to the reaction of 4-vinylbiphenyl with Togni's reagent (**III**) in the presence of $[(\text{MeCN})_4\text{Cu}]\text{PF}_6$. It was found that the desired trifluoromethylation was completely suppressed, which

suggested that the transformation involved a radical process. Based on the above results, we proposed the mechanism as outlined in Scheme 3. Initially, the activation of **III** by Cu(I) led to the formation of radical intermediate **A**. Decomposition of this intermediate produces ((2-(2-iodophenyl)propan-2-yl)oxy)copper(II) (**C**) and a CF_3 radical, which is trapped by alkenes to form the trifluoromethylated radical intermediate **B**. Subsequently, the radical intermediate **B** is oxidized by Cu(II) (**C**) to the cation intermediate **D** with simultaneous release of catalyst Cu(I). In the presence of base, intermediate **D** readily undergoes hydrogen elimination to give the final product.

Conclusion

In conclusion, we have described the copper-catalyzed trifluoromethylation of alkenes with Togni's reagent under mild conditions. The results presented here provided a versatile approach for the construction of $\text{C}_{\text{vinyl}}-\text{CF}_3$ bonds without using prefunctionalized substrates. Investigations on the application of the trifluoromethylation method to the synthesis of pharmaceuticals and agrochemicals are currently underway.

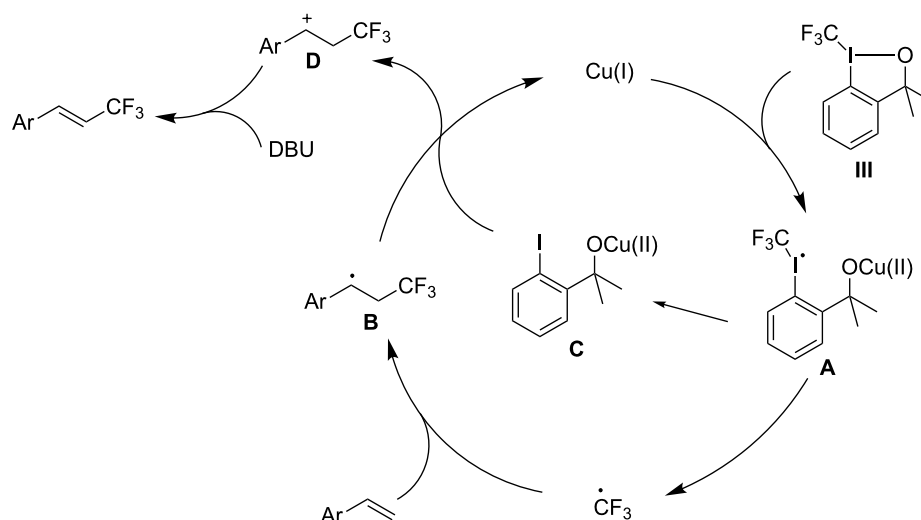

Scheme 3: Proposed mechanism for the trifluoromethylation of terminal alkenes.

Supporting Information

Supporting Information File 1

Full experimental details, analytical data and spectra of the target compounds.

[<http://www.beilstein-journals.org/bjoc/content/supplementary/1860-5397-9-299-S1.pdf>]

Acknowledgements

We thank the National Natural Science Foundation of China (21032006, 21172240), the 973 Program of China (No. 2012CBA01200), the Chinese Academy of Sciences for financial support.

References

- Kirsch, P. *Modern Fluoroorganic Chemistry Synthesis, Reactivity, Applications*; Wiley-VCH: Weinheim, 2004. doi:10.1002/352760393X
- Bégué, J.-P.; Bonnet-Delpon, D. *Bioorganic and Medicinal Chemistry of Fluorine*; John Wiley & Sons: Hoboken, 2008. doi:10.1002/9780470281895
- Schlosser, M. *Angew. Chem., Int. Ed.* **2006**, *45*, 5432–5446. doi:10.1002/anie.200600449
- Müller, K.; Faeh, C.; Diederich, F. *Science* **2007**, *317*, 1881–1886. doi:10.1126/science.11131943
- Hagmann, W. K. *J. Med. Chem.* **2008**, *51*, 4359–4369. doi:10.1021/jm800219f
- Purser, S.; Moore, P. R.; Swallow, S.; Gouverneur, V. *Chem. Soc. Rev.* **2008**, *37*, 320–330. doi:10.1039/b610213c
- Furuya, T.; Kamlet, A. S.; Ritter, T. *Nature* **2011**, *473*, 470–477. doi:10.1038/nature10108
- Zheng, Y.; Ma, J.-A. *Adv. Synth. Catal.* **2010**, *352*, 2745–2750. doi:10.1002/adsc.201000545
- Nie, J.; Guo, H.-C.; Cahard, D.; Ma, J.-A. *Chem. Rev.* **2010**, *111*, 455–529. doi:10.1021/cr100166a
- Parsons, A. T.; Buchwald, S. L. *Nature* **2011**, *480*, 184–185. doi:10.1038/480184a
- Studer, A. *Angew. Chem., Int. Ed.* **2012**, *51*, 8950–8958. doi:10.1002/anie.201202624
- Nagib, D. A.; MacMillan, D. W. C. *Nature* **2011**, *480*, 224–228. doi:10.1038/nature10647
- Pham, P. V.; Nagib, D. A.; MacMillan, D. W. C. *Angew. Chem., Int. Ed.* **2011**, *50*, 6119–6122. doi:10.1002/anie.201101861
- Prakash, G. K. S.; Jog, P. V.; Batamack, P. T. D.; Olah, G. A. *Science* **2012**, *338*, 1324–1327. doi:10.1126/science.1227859
- Pair, E.; Monteiro, N.; Bouyssi, D.; Baudoin, O. *Angew. Chem., Int. Ed.* **2013**, *52*, 5346–5349. doi:10.1002/anie.201300782
- Wang, X.; Xu, Y.; Mo, F.; Ji, G.; Qiu, D.; Feng, J.; Ye, Y.; Zhang, S.; Zhang, Y.; Wang, J. *J. Am. Chem. Soc.* **2013**, *135*, 10330–10333. doi:10.1021/ja4056239
- Lundgren, R. J.; Stradiotto, M. *Angew. Chem., Int. Ed.* **2010**, *49*, 9322–9324. doi:10.1002/anie.201004051
- Tomashenko, O. A.; Grushin, V. V. *Chem. Rev.* **2011**, *111*, 4475–4521. doi:10.1021/cr1004293
- Besset, T.; Schneider, C.; Cahard, D. *Angew. Chem., Int. Ed.* **2012**, *51*, 5048–5050. doi:10.1002/anie.201201012
- Wu, X.-F.; Neumann, H.; Beller, M. *Chem.–Asian J.* **2012**, *7*, 1744–1754. doi:10.1002/asia.201200211
- Oishi, M.; Kondo, H.; Amii, H. *Chem. Commun.* **2009**, 1909–1911. doi:10.1039/b823249k
- Cho, E. J.; Senecal, T. D.; Kinzel, T.; Zhang, Y.; Watson, D. A.; Buchwald, S. L. *Science* **2010**, *328*, 1679–1681. doi:10.1126/science.1190524
- Wang, X.; Truesdale, L.; Yu, J.-Q. *J. Am. Chem. Soc.* **2010**, *132*, 3648–3649. doi:10.1021/ja909522s
- Chu, L.; Qing, F.-L. *J. Am. Chem. Soc.* **2012**, *134*, 1298–1304. doi:10.1021/ja209992w
- Zhang, C.-P.; Wang, Z.-L.; Chen, Q.-Y.; Zhang, C.-T.; Gu, Y.-C.; Xiao, J.-C. *Angew. Chem., Int. Ed.* **2011**, *50*, 1896–1900. doi:10.1002/anie.201006823

26. Zhang, X.-G.; Dai, H.-X.; Wasa, M.; Yu, J.-Q. *J. Am. Chem. Soc.* **2012**, *134*, 11948–11951. doi:10.1021/ja305259n
27. Herrmann, A. T.; Smith, L. L.; Zakarian, A. *J. Am. Chem. Soc.* **2012**, *134*, 6976–6979. doi:10.1021/ja302552e
28. Liu, T.; Shao, X.; Wu, Y.; Shen, Q. *Angew. Chem., Int. Ed.* **2012**, *51*, 540–543. doi:10.1002/anie.201106673
29. Ye, Y.; Sanford, M. S. *J. Am. Chem. Soc.* **2012**, *134*, 9034–9037. doi:10.1021/ja301553c
30. Zeng, Y.; Zhang, L.; Zhao, Y.; Ni, C.; Zhao, J.; Hu, J. *J. Am. Chem. Soc.* **2013**, *135*, 2955–2958. doi:10.1021/ja312711c
31. Dai, J.-J.; Fang, C.; Xiao, B.; Yi, J.; Xu, J.; Liu, Z.-J.; Lu, X.; Liu, L.; Fu, Y. *J. Am. Chem. Soc.* **2013**, *135*, 8436–8439. doi:10.1021/ja404217t
32. Cho, E. J.; Buchwald, S. L. *Org. Lett.* **2011**, *13*, 6552–6555. doi:10.1021/ol202885w
33. Hafner, A.; Bräse, S. *Adv. Synth. Catal.* **2011**, *353*, 3044–3048. doi:10.1002/adsc.201100528
34. Parsons, A. T.; Senecal, T. D.; Buchwald, S. L. *Angew. Chem., Int. Ed.* **2012**, *51*, 2947–2950. doi:10.1002/anie.201108267
35. He, Z.; Luo, T.; Hu, M.; Cao, Y.; Hu, J. *Angew. Chem., Int. Ed.* **2012**, *51*, 3944–3947. doi:10.1002/anie.201200140
36. Yasu, Y.; Koike, T.; Akita, M. *Chem. Commun.* **2013**, *49*, 2037–2039. doi:10.1039/c3cc39235j
37. Li, Z.; Cui, Z.; Liu, Z.-Q. *Org. Lett.* **2013**, *15*, 406–409. doi:10.1021/ol3034059
38. Li, Y.; Wu, L.; Neumann, H.; Beller, M. *Chem. Commun.* **2013**, *49*, 2628–2630. doi:10.1039/c2cc36554e
39. Iqbal, N.; Choi, S.; Kim, E.; Cho, E. J. *J. Org. Chem.* **2012**, *77*, 11383–11387. doi:10.1021/jo3022346
40. Janson, P. G.; Ghoneim, I.; Ilchenko, N. O.; Szabó, K. J. *Org. Lett.* **2012**, *14*, 2882–2885. doi:10.1021/ol3011419
41. Lin, J.-H.; Xiao, J.-C. *Eur. J. Org. Chem.* **2011**, 4536–4539. doi:10.1002/ejoc.201100683
42. Lin, J.-H.; Zong, G.; Du, R.-B.; Xiao, J.-C.; Liu, S. *Chem. Commun.* **2012**, *48*, 7738–7740. doi:10.1039/c2cc18064b
43. Zhang, C.-P.; Wang, Z.-L.; Chen, Q.-Y.; Zhang, C.-T.; Gu, Y.-C.; Xiao, J.-C. *Chem. Commun.* **2011**, *47*, 6632–6634. doi:10.1039/c1cc11765c
44. Zhang, C.-P.; Cai, J.; Zhou, C.-B.; Wang, X.-P.; Zheng, X.; Gu, Y.-C.; Xiao, J.-C. *Chem. Commun.* **2011**, *47*, 9516–9518. doi:10.1039/c1cc13460d
45. Wang, X.; Lin, J.; Zhang, C.; Xiao, J.; Zheng, X. *Chin. J. Chem.* **2013**, *31*, 915–920. doi:10.1002/cjoc.201300393
46. Mu, X.; Wu, T.; Wang, H.-Y.; Guo, Y.-L.; Liu, G. *J. Am. Chem. Soc.* **2012**, *134*, 878–881. doi:10.1021/ja210614y
47. Parsons, A. T.; Buchwald, S. L. *Angew. Chem., Int. Ed.* **2011**, *50*, 9120–9123. doi:10.1002/anie.201104053
48. Wang, X.; Ye, Y.; Zhang, S.; Feng, J.; Xu, Y.; Zhang, Y.; Wang, J. *J. Am. Chem. Soc.* **2011**, *133*, 16410–16413. doi:10.1021/ja207775a
49. Xu, J.; Fu, Y.; Luo, D.-F.; Jiang, Y.-Y.; Xiao, B.; Liu, Z.-J.; Gong, T.-J.; Liu, L. *J. Am. Chem. Soc.* **2011**, *133*, 15300–15303. doi:10.1021/ja206330m
50. Zhu, R.; Buchwald, S. L. *J. Am. Chem. Soc.* **2012**, *134*, 12462–12465. doi:10.1021/ja305840g
51. Miyake, Y.; Ota, S.-I.; Nishibayashi, Y. *Chem.–Eur. J.* **2012**, *18*, 13255–13258. doi:10.1002/chem.201202853
52. Yasu, Y.; Koike, T.; Akita, M. *Angew. Chem., Int. Ed.* **2012**, *51*, 9567–9571. doi:10.1002/anie.201205071
53. Egami, H.; Shimizu, R.; Kawamura, S.; Sodeoka, M. *Angew. Chem., Int. Ed.* **2013**, *52*, 4000–4003. doi:10.1002/anie.201210250
54. Liu, X.; Xiong, F.; Huang, X.; Xu, L.; Li, P.; Wu, X. *Angew. Chem., Int. Ed.* **2013**, *52*, 6962–6966. doi:10.1002/anie.201302673
55. Wu, X.; Chu, L.; Qing, F.-L. *Angew. Chem., Int. Ed.* **2013**, *52*, 2198–2202. doi:10.1002/anie.201208971
56. Mizuta, S.; Verhoog, S.; Engle, K. M.; Khotavivattana, T.; O'Duill, M.; Wheelhouse, K.; Rassias, G.; Médebielle, M.; Gouverneur, V. *J. Am. Chem. Soc.* **2013**, *135*, 2505–2508. doi:10.1021/ja401022x
57. Yang, J.-J.; Kirchmeier, R. L.; Shreeve, J. M. *J. Org. Chem.* **1998**, *63*, 2656–2660. doi:10.1021/jo972213l
See for some references on S-tetrafluoromethyl sulfonium salt.
58. Magnier, E.; Blazejewski, J.-C.; Tordeux, M.; Wakselman, C. *Angew. Chem., Int. Ed.* **2006**, *45*, 1279–1282. doi:10.1002/anie.200503776
See for some references on S-tetrafluoromethyl sulfonium salt.

License and Terms

This is an Open Access article under the terms of the Creative Commons Attribution License (<http://creativecommons.org/licenses/by/2.0>), which permits unrestricted use, distribution, and reproduction in any medium, provided the original work is properly cited.

The license is subject to the *Beilstein Journal of Organic Chemistry* terms and conditions: (<http://www.beilstein-journals.org/bjoc>)

The definitive version of this article is the electronic one which can be found at: [doi:10.3762/bjoc.9.299](http://dx.doi.org/10.3762/bjoc.9.299)

Multigramme synthesis and asymmetric dihydroxylation of a 4-fluorobut-2E-enoate

James A. B. Laurenson^{1,2}, John A. Parkinson¹, Jonathan M. Percy^{*1},
Giuseppe Rinaudo¹ and Ricard Roig^{3,4}

Full Research Paper

Open Access

Address:

¹WestCHEM Department of Pure and Applied Chemistry, University of Strathclyde, Thomas Graham Building, 295 Cathedral Street, Glasgow G1 1XL, United Kingdom, ²Carbosynth Ltd., 93 Innovation Drive, Milton Park, Abingdon, Oxfordshire OX14 4RZ, United Kingdom, ³Department of Chemistry, University of Leicester, University Road, Leicester LE1 7RH, United Kingdom and ⁴Lallemand Gb Ingredients, Dock Road, Felixstowe, Suffolk IP11 3QW, United Kingdom

Email:

Jonathan M. Percy^{*} - jonathan.percy@strath.ac.uk

* Corresponding author

Keywords:

asymmetric; dihydroxylation; ee determination; fluorination; fluorosugars; organo-fluorine

Beilstein J. Org. Chem. **2013**, *9*, 2660–2668.

doi:10.3762/bjoc.9.301

Received: 27 August 2013

Accepted: 08 November 2013

Published: 26 November 2013

This article is part of the Thematic Series "Organo-fluorine chemistry III".

Guest Editor: D. O'Hagan

© 2013 Laurenson et al; licensee Beilstein-Institut.

License and terms: see end of document.

Abstract

Esters of crotonic acid were brominated on a multigramme scale using a free radical procedure. A phase transfer catalysed fluorination transformed these species to the 4-fluorobut-2E-enoates reproducibly and at scale (48–53%, ca. 300 mmol). Asymmetric dihydroxylation reactions were then used to transform the butenoate, ultimately into all four diastereoisomers of a versatile fluorinated C₄ building block at high enantiomeric-enrichment. The (DHQ)₂AQN and (DHQD)₂AQN ligands described by Sharpless were the most effective. The development and optimisation of a new and facile method for the determination of ee is also described; ¹⁹F {¹H} spectra recorded in *d*-chloroform/diisopropyl tartrate showed distinct baseline separated signals for different enantiomers.

Introduction

Selective fluorination can be used to make subtle but decisive modifications of molecular properties. Sugar chemistry has proved particularly fertile ground for studies of this type; fluorine atoms can be used to replace hydroxy groups or hydrogen atoms, modifying the arrays of hydrogen bond donors and acceptors, and electron demand at the anomeric centre at minimal steric cost. Modifications of this type are sometimes accepted by sugar-processing enzymes such as the kinases and

transferases involved in oligosaccharide assembly, or in antibiotic biosynthesis. Mechanistic insights, and new routes to hybrid natural products represent the rewards of this endeavour [1-10].

The synthesis of fluorinated analogues of sugars can be approached in two strategically different ways. The most common, and often most efficient approach, identifies a sugar

precursor, isolates the locus for fluorination (usually an hydroxy group) by protecting all the other functional groups, and transforms it using a nucleophilic fluorinating agent [11].

The main advantages of this approach are that pre-existing stereogenic centres remain intact, while accurate inversion of configuration occurs at the locus of reaction. For one of the most common transformations, which delivers 6-deoxy-6-fluoro sugars, the locus of reaction is not even a stereogenic centre. The synthesis of 6-fluoro-D-olivose (**6**) in 23% overall yield from optically pure D-glucose (**1**) by O'Hagan and Nieschalk (Scheme 1) provides an impressive example of the approach [12].

Isolation of the C-6 hydroxy group in **2** set the stage for mesylation, and conversion of **3** to fluoride **4** with an extremely economical reagent. Acetal cleavage and peracetylation released glycoside **5** which was converted to **6** via known methods. The main disadvantages of the approach are the extensive use which must be made of protection/deprotection chemistry, and in some cases, the availability of the precursor sugar. Some less

common sugars are expensive and available in limited quantities.

The alternative approach involves de novo stereodivergent synthesis, which elaborates small fluorinated building blocks using the reactions of modern catalytic asymmetric chemistry; this approach still has a very restricted repertoire. Few versatile building blocks are available, particularly in supra-millimol quantities, and other disadvantages include the need to carry an expensive fluorinated material through many steps, and requirements for chromatographic separations of diastereoisomers. The costs and benefits of the de novo approach were illustrated by our recent asymmetric, stereodivergent route to selected 6-deoxy-6-fluorohexoses in which we transformed a fluorinated hexadienoate **9** into the fluorosugars 6-deoxy-6-fluoro-L-idose, 6-fluoro-L-fucose (**13**, shown) and 6-deoxy-6-fluoro-D-galactose (Scheme 2) [13].

The main challenges we faced included the synthesis of **9** and its bromide precursor **8** in acceptable yield and purity, and the unexpectedly low regioselectivity of AD reactions of the fluori-

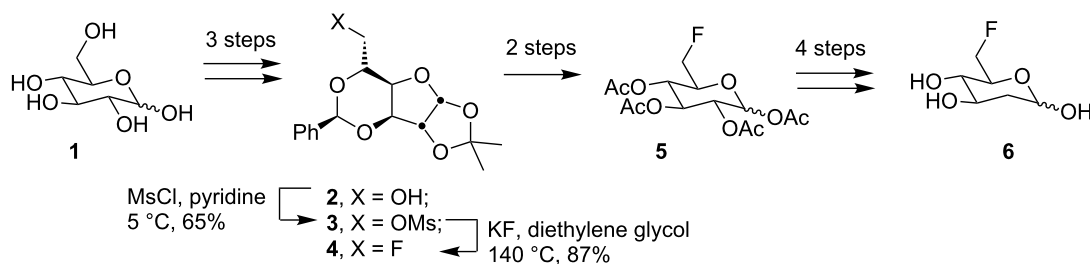

Scheme 1: Key steps from the synthesis of 6-fluoro-D-olivose (**6**) from D-glucose (**1**).

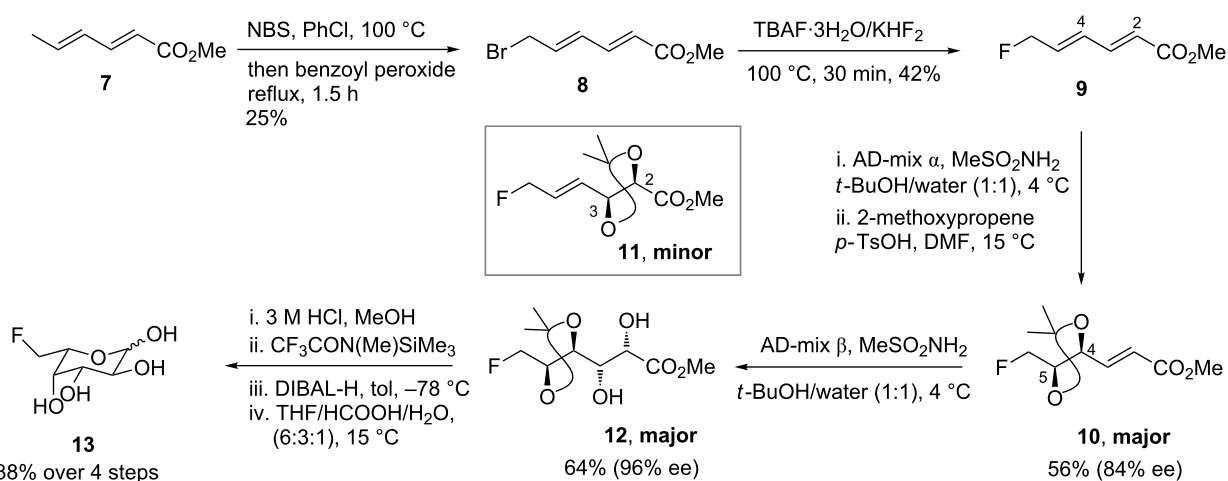

Scheme 2: De novo asymmetric syntheses of 6-deoxy-6-fluorohexoses [13].

nated dienoate. Methyl sorbate (**7**) underwent AD across the C-4/C-5 alkenyl group exclusively, but the introduction of the fluorine atom at C-6 lowered the selectivity (**10:11**) to 5:1 with AD-mix- α and 4:1 with AD-mix- β .

Nevertheless, de novo stereodivergent approaches are conceptually important and pave the way to wider ranges of more unnatural species. We decided to solve the problem of low regioselectivity from the hexadienoate, and to discover a more stereodivergent repertoire, by attempting to develop asymmetric chemistry based on a smaller butenoate (C_4) building block, **14**.

Results and Discussion

Fluorides of type **14** are uncommon in the literature (Scheme 3); silver mediated fluorination of butenyl bromide **15** is known [14] delivering **16** in moderate yield but via a slow and expensive reaction. Wittig reaction, following in situ reduction of ethyl fluoroacetate (**17**) has been reported [15], while Purrington [16] prepared **19** by direct fluorination of silylketene acetal **18** with elemental fluorine.

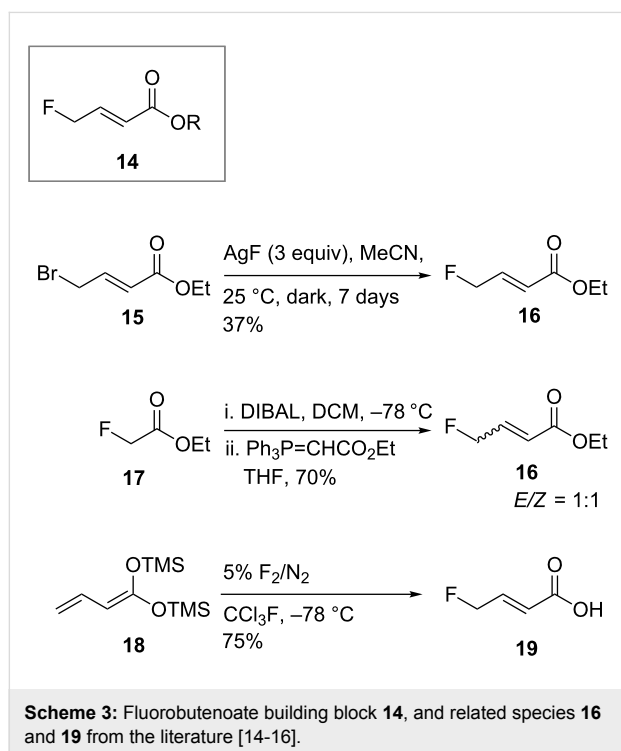

We decided to explore a halogen exchange approach from crotonic acid (**20**) which is commercially available cheaply, and in high diastereoisomeric purity (>98%). Diastereomeric purity is particularly important as the de novo syntheses must deliver the highest enantiomeric purity possible to be competitive with syntheses from enantiomerically pure natural products. *n*-Propyl and isopropyl esters **21** and **22** were prepared (0.5 mol scale) to moderate the volatility of intermediates, while retaining the option of distillation as a method of purification. Bromination was carried out using the method of Lester et al. [17], and while it was effective at small scales, larger scale (>150 mmol) reactions were violently exothermic. A modification of the reaction order reported earlier by Gershon and coworkers solved the problem [18]. Chlorobenzene was effective as the reaction solvent instead of carbon tetrachloride, allowing **23** and **24** to be isolated safely and reproducibly at scale (>300 mmol) in moderate yield (48–53%) after Kugelrohr distillation (Scheme 4).

Fluorination was attempted using a range of conditions. The solvent-free reaction developed within our laboratory using commercial TBAF and KHF_2 was not sufficiently effective for this substrate [13,19]. The yield of the product was moderate (37%), but the purification of the product was extremely difficult due to the complex mixture of products.

Allyl alcohol **27** (Figure 1) and starting material **23** were present and difficult to separate. During the course of this project, TBAF·(*t*-BuOH)₄ was reported to be more effective than other fluoride sources. Kim and co-workers [20] reported that the reagent was obtained as a non-hygroscopic crystalline white solid after refluxing commercial TBAF in a mixture of hexane and *t*-BuOH; importantly, they claimed that it can be considered as a truly anhydrous source of the TBAF reagent. We were completely unable to reproduce the reagent preparation.

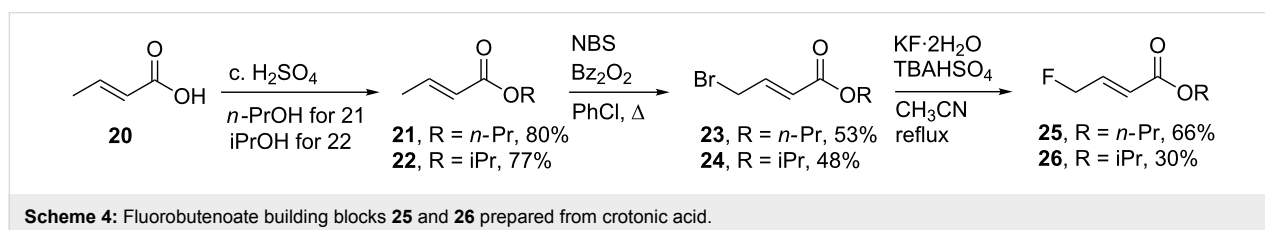
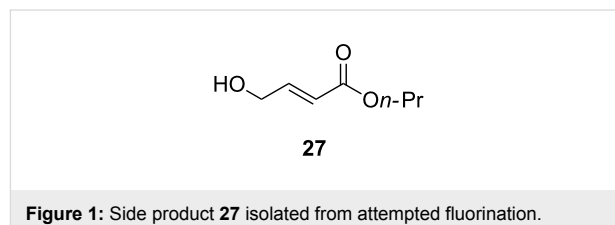

ation reported in the literature; all the materials we were able to make were extremely hygroscopic indeed, and exposure of **23** or **24** to them resulted in complete decomposition to a very complex mixture of products. However, the phase transfer catalysed procedure described by Hou and co-workers [21] which used TBAHSO₄ and KF·2H₂O in refluxing acetonitrile successfully effected the fluorination to allyl fluorides **25** and **26** on both small and large scales (>150 mmol). Rapid Kugelrohr distillation under reduced pressure was attempted initially but the quality of the distilled material was unsatisfactory. Fractional distillation through a Vigreux column at reduced pressure yielded the desired fluorides in an acceptable level of purity (>95% by ¹H NMR) and reproducibly on a large scale (up to ~200 mmol). These outcomes represent significant practical improvements on the published methods of preparation. The subsequent transformations were carried out on the *n*-propyl ester **25** for two reasons; firstly, the material can be made in

much higher yield, and the *n*-propyl ester can be cleaved under milder conditions than the isopropyl ester in **26**.

Although the commercial AD-mixes (0.4 mol % osmium/ 1 mol % ligand) can transform most standard substrates smoothly, osmium tetroxide is an electrophilic reagent [22], and electron deficient olefins, such as unsaturated amides and esters, react relatively slowly [23].

It was thought that the so-called “improved procedure” [24], which uses higher ligand/oxidant loadings (1 mol % osmium/ 5 mol % ligand) might be required to allow the reactions to proceed in acceptable yields and enantioselectivities [25]. Figure 2 shows the panel of ligands used for the asymmetric dihydroxylation transformations. Scheme 5 shows the initial dihydroxylation carried out on **25**, and Table 1 summarises the method development.

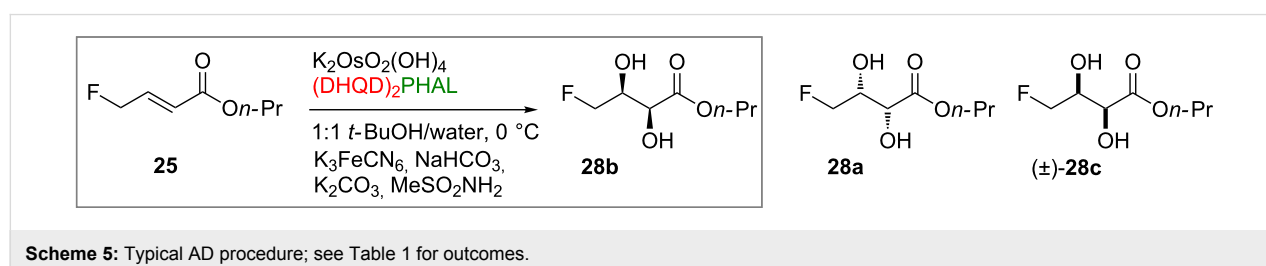
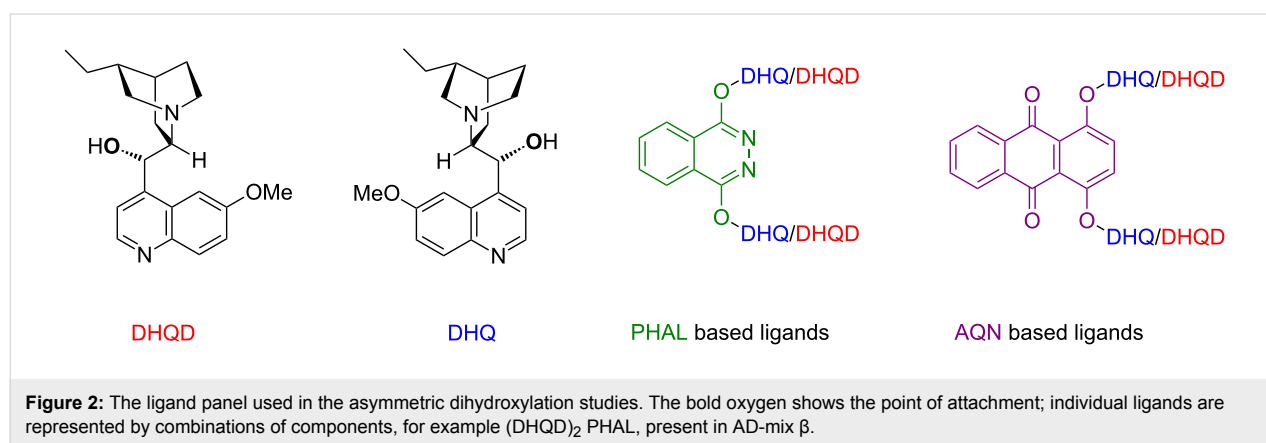

Table 1: Relationship between conditions, ligand and dihydroxylation ee.

Conditions	Ligand type	DHQ/α-	DHQD/β-
Standard			
0.4 mol % osmium, 1 mol % ligand	PHAL	66% ee	72% ee
2 mol % osmium, 2 mol % ligand	PHAL	80% ee	89% ee
Improved			
1 mol % osmium, 5 mol % ligand	PHAL	83% ee	91% ee
1 mol % osmium, 10 mol % ligand	PHAL	82% ee	90% ee
1 mol % osmium, 5 mol % ligand	AQN	95% ee	97% ee

The asymmetric dihydroxylation conditions were subject to some optimization; the osmium and chiral ligand contents were varied in the first instance. While the commercial AD-mixes were used, we also carried out the dihydroxylations with 1 mol % osmium/5 mol % ligand, the so-called “improved procedure”, and with 1 mol % osmium/10 mol % ligand (results summarised in Table 1). Methyl sulfonamide which can accelerate hydrolysis and catalytic turnover was also added to the reaction mixtures [26].

Yields for the dihydroxylation chemistry were variable (44–80%); even though they are diols, these small molecules proved volatile. Reproducible yields (>55%) could be achieved if care was taken with solvent removal.

The “improved conditions” (1 mol % osmium, 5 mol % ligand) were found to give results comparable (within experimental error) to those obtained with the 2 mol % osmium/2 mol % ligand and 1 mol % osmium/10 mol % ligand conditions, suggesting the ee could not be indefinitely improved by increasing the ligand or osmium concentrations. Sharpless has reported that the (DHQ)₂AQN and (DHQD)₂AQN ligands based on the anthraquinone core, (Figure 2), are superior ligands for olefins bearing heteroatoms in the allylic position [27].

An asymmetric dihydroxylation reaction was performed using the improved Sharpless conditions with the newer AQN based ligands, producing excellent ee's for both enantiomers of the diol, 95% for the enantiomer derived from AD-mix α , and 97% for the enantiomer from AD-mix β (Table 1). The corresponding isolated yields under these conditions were 54% and 56% respectively.

The ee's were measured after conversion of the diols to the dibenzoates **29** upon stirring overnight with benzoic anhydride, DMAP and polyvinylpyridine (PVP) at room temperature. The removal of the base by filtration was facile (Scheme 6).

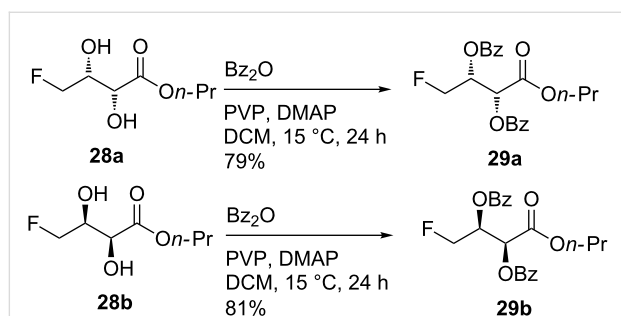

Scheme 6: Conversion of enantiomerically-enriched diols to dibenzoates for HPLC analysis.

Genuine racemate **28c** was synthesised via the Upjohn oxidation (catalytic osmium tetroxide, NMO aqueous *t*-BuOH, 83%) of **25** to avoid ambiguity, and converted to the dibenzoate **29c** (not shown, 80%) as described above.

The dibenzoates were purified by flash chromatography then examined by chiral HPLC (Chiralcel OD, 2% *i*PrOH in hexane). The separation of the enantiomers **29a** and **29b** was excellent, with over 6 minutes separating the stereoisomers in the chromatograms. Due to the robust nature of the dibenzoate chemistry and the excellent chromatograms produced, the derivatisation/chiral HPLC assay was used routinely.

However, direct measurement of the ee's of the fluorinated diols **28a** and **28b** could not be achieved by the HPLC method. The very low absorbance of light at 235 nm resulted in unreliable data; small peak areas were observed for the desired compound with comparatively large peak areas for the background and trace impurities (as judged by ¹H and ¹³C NMR spectra). Attempts to use RI detection in the chiral HPLC were no more successful. A new analytical method was therefore sought which would allow the ee's of the diols to be measured quickly and directly using ¹⁹F{¹H} NMR, avoiding the introduction of additional synthetic steps.

The determination of enantiomeric excesses using NMR is a well-established technique [28]; tactics include in situ derivatisation [29], may rely on very specific functionality [30] or may use expensive and/or structurally complex shift reagents [31]. The necessity of these reagents arises from the need to examine a single peak in a high level of detail despite the often cluttered nature of ¹H (and ¹³C) NMR spectra, especially with large or complex structures. NMR determination of enantiomeric purity using chiral solvents though less well known has been described in the literature [32] and is particularly effective when heteroatomic NMR techniques are used [33]. For example, α -methylbenzylamine was used to resolve the components of the racemate of 2,2,2-trifluoro-1-phenylethanol in the ¹⁹F NMR spectrum ($\Delta\delta_F$ was 0.04 ppm) [34] and in another case, a chiral liquid crystalline medium was used to resolve racemic mixtures of fluoroalkanes very effectively [35]. When solubilised in a chiral environment like diisopropyl L-tartrate (**30**, Figure 3), the formation of diastereoisomeric solvation complexes results in magnetic non-equivalence and hence the appearance of separate signals for the complexes in the NMR experiment.

Recording the ¹⁹F{¹H} NMR spectra will take advantage of the high sensitivity of ¹⁹F NMR detection and optimise *S/N* through the removal of splittings to protons. The NMR experiment was performed by diluting the substrate in an NMR tube with a 1:1 w/w mixture of diisopropyl L-tartrate and CDCl₃. Racemic diol

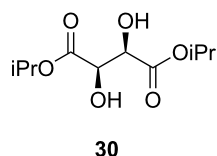

Figure 3: Diisopropyl L-tartrate (**30**) used as a chiral modifier for NMR determination of ee.

28c analysed under these conditions by $^{19}\text{F}\{^1\text{H}\}$ NMR showed almost complete separation of the two enantiomers ($\Delta\delta_{\text{F}} = 0.02$ ppm). However, more complete peak separation was required before reliable integrations could be made (Figure 4).

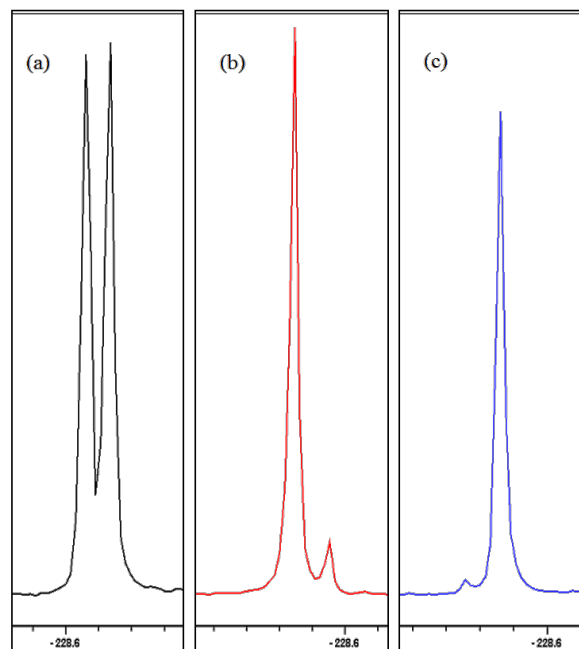

Figure 4: Partial $^{19}\text{F}\{^1\text{H}\}$ NMR spectra (376 MHz, L-(+)-DIPT/ CDCl_3 , 300 K) spectra of (a) racemate **28c**, (b) diol **28b** and (c) **28a** under standard acquisition parameters revealing the partial enantiomer overlap.

Alterations to the NMR acquisition parameters were made in an effort to improve the baseline resolution and separate the peaks fully.

Initial modifications caused a decrease in the quality of the spectra produced, with signal broadening and a reduction in the peak separation observed, caused by sample heating within the probe (decoupling produces heating of the sample) at the longer acquisition times. A set of experimental parameters that would allow a narrowing of the sweep width (SW), but maintain short acquisition (AQ) and relaxation times, and therefore minimise

sample heating was devised; the optimised spectra are shown in Figure 5.

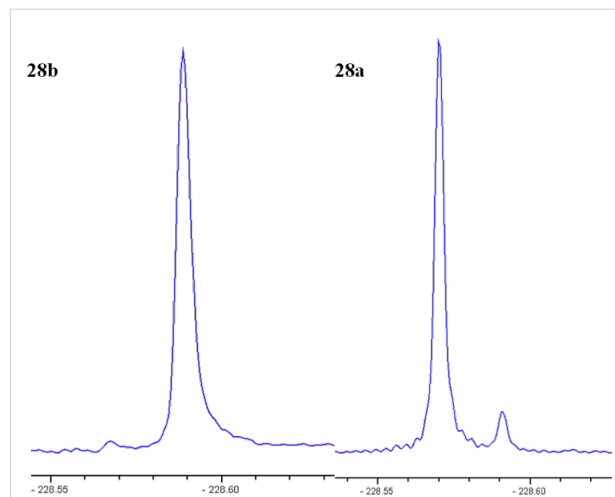

Figure 5: Partial $^{19}\text{F}\{^1\text{H}\}$ NMR (400 MHz, L-(+)-DIPT/ CDCl_3 , 300 K) spectra of **28b** and **28a** using optimised conditions: SW 40; AQ = 0.8; O1P -230; d1 = 5; 32 or 64 scans.

The results obtained from integration of the signals for each enantiomer matched the chiral HPLC analysis of the derivatised dibenzoates closely; for example the ee's for **28b** and **28a**, from the 1 mol % osmium, 5 mol % PHAL conditions, were 82% and 91% by NMR respectively and 83% and 91% by HPLC for the corresponding dibenzoates **29b** and **29a**.

The $^{19}\text{F}\{^1\text{H}\}$ NMR method uses a cheap readily available chiral solvating agent, is rapid (2 minutes per sample) and simple to perform. Although the technique is sacrificial in the sample, the quantities of sample required (<2 mg) are negligible. We make no claims for the generality of the method, but for molecules of this type, it appears highly effective.

To make our route stereodivergent, we sought access to the two *anti* diastereoisomers **35a** and **35b** via cyclic sulfate methodology (Scheme 7) [36,37].

Cyclic sulfate **32b** was prepared via literature procedures [36,37], monitoring the steps closely by $^{19}\text{F}\{^1\text{H}\}$ NMR spectroscopy which distinguishes all the species effectively. In **32b**, C-3 is primed for regioselective nucleophilic attack [38]. Crude cyclic sulfate **32b** was taken up in acetone, treated with solid ammonium benzoate and allowed to stir at room temperature overnight. Nucleophilic ring opening reactions were performed on the crude cyclic sulfate mixtures because avoiding column chromatography at this stage led to a vast improvement in the overall yields. After ring opening, sulfate ester cleavage was achieved by stirring the concentrated residue in acid (20%

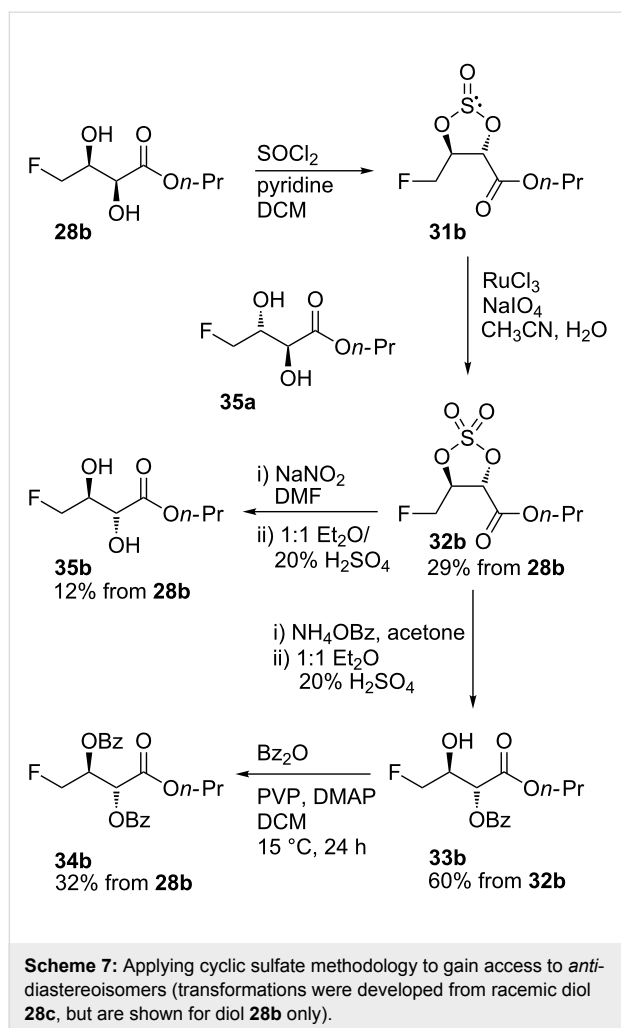

H₂SO₄) and ether, yielding the desired monobenzoate in moderate yield (60%) after purification. The regiochemistry of the ring opening was revealed in the HMBC spectrum of monobenzoate **33b**. The ¹H NMR signal corresponding to the C-2 methine proton couples (³J_{C-H}) to both carbonyl signals in the ¹³C spectrum. This indicates that both carbonyl groups are within 3 bonds of the hydrogen on C-2. However, the signal from the hydrogen on C-3 couples to the carbonyl carbon of the *n*-propyl ester only, confirming the expected regiochemistry for structure **33b**. Dibenzoate **34b** was synthesised (32% overall from **28b**) directly from the crude reaction mixture (Scheme 7) by treatment of the crude monobenzoate **33b** with benzoic anhydride in the presence of DMAP and PVP. The *syn*- and *anti*-dibenzoates have distinct signals in the ¹⁹F NMR spectra (δ_F –230.3 and –231.0 ppm respectively), allowing a very high level of confidence that the ring-opening of the *syn*-cyclic sulfates does not produce *syn*-dibenzoate, and that epimerisation is not competitive with ring-opening. This was further supported by chiral HPLC analyses of the dibenzoates, which also suggests that clean conversion occurs, without epimerisation.

All four dibenzoates had distinct retention times in the chiral HPLC chromatograms.

For the inversion of the diol stereochemistry to be synthetically useful, a less basic synthetic equivalent for hydroxide was required. When Mitsunobu chemistry fails, O'Doherty and co-workers have achieved hydroxy group inversion by triflation and displacement using sodium nitrite [39]. Cyclic sulfate **32b** was exposed to sodium nitrite in DMF; the mixture was heated at reflux until completion of the reaction was confirmed by ¹⁹F NMR. Subsequent acid cleavage of the sulfate ester afforded the desired *anti*-diols in a disappointing yield (12% overall from **28b**) after purification. The low yield was attributed to the small scale of the reaction and difficulty of the work-up caused by the presence of DMF. Unfortunately, attempts to carry out the reaction in acetone led to complete decomposition of the substrate.

A proof-of-concept extension sequence of the C₄ building block was sought. Cyclohexylidene protection was chosen to add bulk and in aspiration to crystalline intermediates (Scheme 8).

After some initial failures, cyclohexylidene **36b** formed effectively in the presence of Lewis acid BF₃·OEt₂ in ethyl acetate [40]. Ester reduction with DIBAL-H afforded alcohol **37b**; delaying purification of the products until after the reduction step increased the overall yield from butenoate **25** to 25% over 3 steps and in excellent diastereoisomeric purity. In contrast, the preparation of **37a** with purifications at each stage delivered **37a** in 3% overall yield. A one-pot oxidation/Wittig procedure was implemented from **37a**; treatment with the Dess–Martin periodinane [41] in the presence of the stabilised ylide afforded a 4:1 *E:Z* mixture of the product alkene **39a** in good (74%) yield. A second purification by column chromatography isolated the *E*-alkene diastereoisomer of **39a** in 37% yield together with a mixed fraction of the *E*- and *Z*-alkenes. The *E*-isomer was identified by the alkene vicinal coupling values in the ¹H NMR spectrum, and *E:Z* ratios were measured by integration of the distinct signals in the ¹⁹F{¹H} NMR spectra. Analysis of the pure *E*-alkene using the chiral ¹⁹F{¹H} NMR method revealed that the ee was unchanged from the diol **28a**, confirming epimerisation was not occurring during the subsequent reactions (aldehyde **38a** was of particular concern).

The synthesis of alkenes **39** is particularly significant, as at this stage the crotonic acid route overlaps with the published syntheses of 6-deoxy-6-fluorohexoses from methyl sorbate [13].

The main benefits of the crotonic acid route are the absence of regioisomers as the double bond is installed after the asymmetric oxidation and the potential to deliver all of the 6-deoxy-

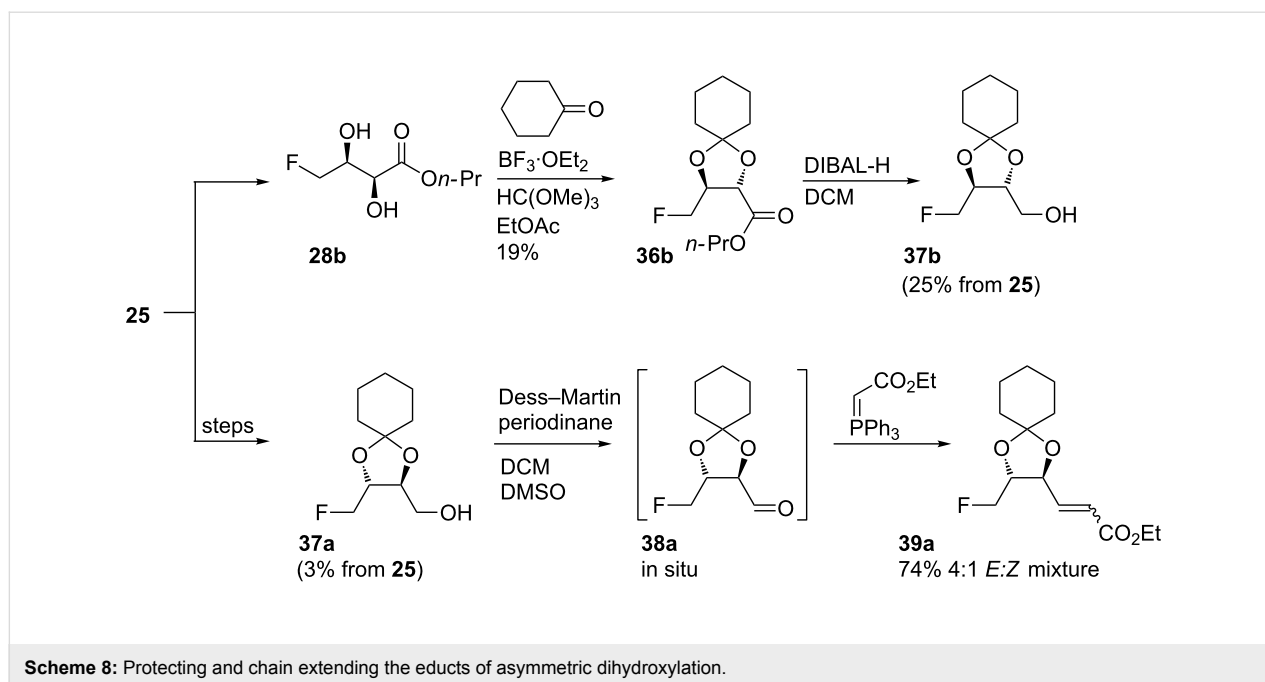

6-fluorohexose isomers, as the cyclic sulfate chemistry can generate the previously inaccessible *anti*-diol relationships, either at C2–C3, C4–C5 or both.

Conclusion

A practical route which affords 4-fluorobut-2*E*-enoates reproducibly and at scale (48–53%, ca. 300 mmol) has been developed, improving significantly on published methods. Catalytic asymmetric dihydroxylation can be carried out in moderate to good yields and in excellent ee using the AQN ligands. Chiral HPLC was used for ee determination of the dibenzoate derivatives, but a chiral $^{19}\text{F}\{^1\text{H}\}$ NMR method was developed to determine the enantiomeric purities of the non-chromophoric *syn*-diol products. Educt elaboration was achieved via cyclic sulfate methodology, leading to the stereocomplementary *anti*-diols, and via acetal protection, ester reduction and one-pot oxidation/Wittig reaction, re-connecting this study to the published route to 6-deoxy-6-fluorohexoses.

Experimental

A full range of experimental procedures and characterisation data is presented in Supporting Information File 1.

Supporting Information

Supporting Information File 1

Experimental procedures and characterization data.

[<http://www.beilstein-journals.org/bjoc/content/supplementary/1860-5397-9-301-S1.pdf>]

Acknowledgements

This work was supported by the University of Leicester (studentship to R.R.), the Engineering and Physical Sciences Research Council (EPSRC, GR/S82053/02, fellowship to G.R., consumable support to R.R., J.A.B.L.), the University of Strathclyde Principal's Fund (fellowship to G.R.) and WestCHEM (studentship to J.A.B.L.). We also thank the EPSRC National Mass Spectrometry Service Centre, University of Wales Swansea for accurate mass spectrometric measurements.

References

- Tsuchiya, T. *Adv. Carbohydr. Chem. Biochem.* **1990**, *48*, 91. doi:10.1016/S0065-2318(08)60032-3
- Hartman, M. C. T.; Jiang, S.; Rush, J. S.; Waechter, C. J.; Coward, J. K. *Biochemistry* **2007**, *46*, 11630. doi:10.1021/bi700863s
- Compain, P.; Martin, O. R. *Curr. Top. Med. Chem.* **2003**, *3*, 541. doi:10.2174/1568026033452474
- Murray, B. W.; Wittmann, V.; Burkart, M. D.; Hung, S.-C.; Wong, C.-H. *Biochemistry* **1997**, *36*, 823. doi:10.1021/bi962284z
- Withers, S. G.; MacLennan, D. J.; Street, I. P. *Carbohydr. Res.* **1986**, *154*, 127. doi:10.1016/S0008-6215(00)90028-4
- Sianidis, G.; Wohler, S.-E.; Pozidis, C.; Karamanou, S.; Luzhetskyy, A.; Vente, A.; Economou, A. *J. Biotechnol.* **2006**, *125*, 425. doi:10.1016/j.jbiotec.2006.03.035
- Burkart, M. D.; Vincent, S. P.; Düffels, A.; Murray, B. W.; Ley, S. V.; Wong, C.-H. *Bioorg. Med. Chem.* **2000**, *8*, 1937. doi:10.1016/S0968-0896(00)00139-5
- Schengrund, C.-L.; Kováč, P. *Carbohydr. Res.* **1999**, *319*, 24. doi:10.1016/S0008-6215(99)00104-4
- Ichikawa, Y.; Lin, Y. C.; Dumas, D. P.; Shen, G. J.; Garcia-Junceda, E.; Williams, M. A.; Bayer, R.; Ketcham, C.; Walker, L. E. *J. Am. Chem. Soc.* **1992**, *114*, 9283. doi:10.1021/ja00050a007

10. Errey, J. C.; Mann, M. C.; Fairhurst, S. A.; Hill, L.; McNeil, M. R.; Naismith, J. H.; Percy, J. M.; Whitfield, C.; Field, R. A. *Org. Biomol. Chem.* **2009**, *7*, 1009–1016. doi:10.1039/b815549f
11. Dax, K. *Sci. Synth.* **2006**, *34*, 71.
12. Nieschalk, J.; O'Hagan, D. *J. Fluorine Chem.* **1998**, *91*, 159. doi:10.1016/S0022-1139(98)00220-6
13. Caravano, A.; Field, R. A.; Percy, J. M.; Rinaudo, G.; Roig, R.; Singh, K. *Org. Biomol. Chem.* **2009**, *7*, 996. doi:10.1039/b815342f
14. Guha, S. K.; Shibayama, A.; Abe, D.; Sakaguchi, M.; Ukaji, Y.; Inomata, K. *Bull. Chem. Soc. Jpn.* **2004**, *77*, 2147. doi:10.1246/bcsj.77.2147
15. Li, Q.; Wang, W.; Berst, K. B.; Claiborne, A.; Hasvold, L.; Raye, K.; Tufano, M.; Nilius, A.; Shen, L. L.; Flamm, R.; Alder, J.; Marsh, K.; Crowell, D.; Chu, D. T. W.; Plattner, J. J. *Bioorg. Med. Chem. Lett.* **1998**, *8*, 1953. doi:10.1016/S0960-894X(98)00355-2
16. Purrington, S. T.; Woodard, D. L.; Cale, N. C. *J. Fluorine Chem.* **1990**, *48*, 345. doi:10.1016/S0022-1139(00)80219-5
17. Durrant, G.; Green, R. H.; Lambeth, P. F.; Lester, M. G.; Taylor, N. R. *J. Chem. Soc., Perkin Trans. 1* **1983**, 2211. doi:10.1039/P19830002211
18. Gershon, H.; Shanks, L.; Gawiak, D. E. *J. Med. Chem.* **1976**, *19*, 1069. doi:10.1021/jm00230a019
19. Percy, J. M.; Roig, R.; Singh, K. *Eur. J. Org. Chem.* **2009**, 1058. doi:10.1002/ejoc.200801130
20. Kim, D. W.; Jeong, H.-J.; Lim, S. T.; Sohn, M.-H. *Angew. Chem., Int. Ed.* **2008**, *47*, 8404. doi:10.1002/anie.200803150
21. Fan, R.-H.; Zhou, Y.-G.; Zhang, W.-X.; Hou, X.-L.; Dai, L.-X. *J. Org. Chem.* **2004**, *69*, 335. doi:10.1021/jo034895k
22. Kolb, H. C.; VanNieuwenhze, M. S.; Sharpless, K. B. *Chem. Rev.* **1994**, *94*, 2483. doi:10.1021/cr00032a009
23. Walsh, P. J.; Sharpless, K. B. *Synlett* **1993**, 605. doi:10.1055/s-1993-22548
24. Blundell, P.; Ganguly, A. K.; Girijavallabhan, V. M. *Synlett* **1994**, 263. doi:10.1055/s-1994-22820
25. Körber, K.; Risch, P.; Brückner, R. *Synlett* **2005**, 2905. doi:10.1055/s-2005-921915
26. Morikawa, K.; Park, J.; Andersson, P. G.; Hashiyama, T.; Sharpless, K. B. *J. Am. Chem. Soc.* **1993**, *115*, 8463. doi:10.1021/ja00071a072
27. Becker, H.; Sharpless, K. B. *Angew. Chem., Int. Ed. Engl.* **1996**, *35*, 448. doi:10.1002/anie.199604481
28. Gupta, A. K.; Kazlauskas, R. J. *Tetrahedron: Asymmetry* **1992**, *3*, 243. doi:10.1016/S0957-4166(00)80201-3
29. Chi, Y.; Peelen, T. J.; Gellman, S. H. *Org. Lett.* **2005**, *7*, 3469. doi:10.1021/ol051174u
30. Bergmann, H.; Grosch, B.; Sitterberg, S.; Bach, T. *J. Org. Chem.* **2004**, *69*, 970. doi:10.1021/jo0354847
31. Enders, D.; Thomas, C. R.; Runsink, J. *Tetrahedron: Asymmetry* **1999**, *10*, 323. doi:10.1016/S0957-4166(99)00003-8
32. Bailey, D. J.; O'Hagan, D.; Tavasli, M. *Tetrahedron: Asymmetry* **1997**, *8*, 149. doi:10.1016/S0957-4166(96)00495-8
33. Parker, D. *Chem. Rev.* **1991**, *91*, 1441. doi:10.1021/cr00007a009
34. Pirkle, W. H. *J. Am. Chem. Soc.* **1966**, *88*, 1837. doi:10.1021/ja00960a060
35. Tavasli, M.; Courtieu, J.; Goss, R. J. M.; Meddour, A.; O'Hagan, D. *Chem. Commun.* **2002**, 844. doi:10.1039/b200992g
36. Gao, Y.; Sharpless, K. B. *J. Am. Chem. Soc.* **1988**, *110*, 7538. doi:10.1021/ja00230a045
37. Xiong, C.; Wang, W.; Hruby, V. J. *J. Org. Chem.* **2002**, *67*, 3514. doi:10.1021/jo011172x
38. Byun, H.-S.; He, L.; Bittman, R. *Tetrahedron* **2000**, *56*, 7051. doi:10.1016/S0040-4020(00)00494-4
39. Guo, H.; O'Doherty, G. A. *J. Org. Chem.* **2008**, *73*, 5211. doi:10.1021/jo800691v
40. Gerard, B.; Sangji, S.; O'Leary, D. J.; Porco, J. A., Jr. *J. Am. Chem. Soc.* **2006**, *128*, 7754. doi:10.1021/ja062621j
41. Jones, G. B.; Wright, J. M.; Rush, T. M.; Plourde, G. W., II; Kelton, T. F.; Mathews, J. E.; Huber, R. S.; Davidson, J. P. *J. Org. Chem.* **1997**, *62*, 9379. doi:10.1021/jo9716035

License and Terms

This is an Open Access article under the terms of the Creative Commons Attribution License (<http://creativecommons.org/licenses/by/2.0>), which permits unrestricted use, distribution, and reproduction in any medium, provided the original work is properly cited.

The license is subject to the *Beilstein Journal of Organic Chemistry* terms and conditions: (<http://www.beilstein-journals.org/bjoc>)

The definitive version of this article is the electronic one which can be found at: [doi:10.3762/bjoc.9.301](http://dx.doi.org/10.3762/bjoc.9.301)

Diastereoselectivity in the Staudinger reaction of pentafluorosulfanylaldimines and ketimines

Alexander Penger, Cortney N. von Hahmann, Alexander S. Filatov
and John T. Welch*

Letter

Open Access

Address:
Department of Chemistry, University at Albany, SUNY, 1400
Washington Ave., Albany, NY 12222, USA

Email:
John T. Welch* - jwelch@albany.edu

* Corresponding author

Keywords:
aldimine; Cornforth transition state; diastereoselectivity; β -lactam;
organo-fluorine; α -pentafluorosulfanyl aldehyde

Beilstein J. Org. Chem. 2013, 9, 2675–2680.
doi:10.3762/bjoc.9.303

Received: 07 August 2013
Accepted: 15 October 2013
Published: 27 November 2013

This article is part of the Thematic Series "Organo-fluorine chemistry III".

Guest Editor: D. O'Hagan

© 2013 Penger et al; licensee Beilstein-Institut.
License and terms: see end of document.

Abstract

β -Lactams were diastereoselectively formed by the reaction of SF₅-containing aldimines, or an SF₅-containing ketimine, with benzyloxyketene in a conrotatory ring closure process. Imine formation and cyclization were possible in spite of the acidification of protons on the carbon bound to SF₅. The reactions of the aldimines demonstrated very good 1,2-*lk* diastereoselectivity, however lack of stereochemical control of the C–N ketimine geometry was reflected in the stereochemistry of the product β -lactam. Cyclization of imines with a stereogenic center bearing SF₅ was reflected in the 1,2-*lk, lk* selectivity of the β -lactam.

Introduction

The pentafluorosulfanyl (SF₅) group is one of the few truly new functional groups to be introduced to synthetic organic chemistry in the last 100 years [1-6]. With pseudooctahedral geometry around sulfur, the SF₅ group is a unique substituent for the medicinal or pharmaceutical chemist. While the electron withdrawing properties of the SF₅ and CF₃ groups are similar [7,8], the electronegativity of the SF₅ group has been suggested to be as high as 3.65 in contrast to 3.36 for CF₃ [9]. The inductive σ_I and σ_R values for SF₅, 0.55 and 0.11 [10], contrast with σ_I and σ_R values for CF₃ of 0.39 and 0.12 [11,12] illustrating the increased inductive effect of the SF₅ group relative to the CF₃

group. This effect can also be seen in the calculated dipole moments of 1,1,1-trifluoroethane and pentafluorosulfanylmethane of 2.589 and 3.556 Debye respectively [7,8]. When these electronic effects are combined with an occupied volume only slightly less than that of a *tert*-butyl group [3,13], the SF₅ group can have unanticipated influences on the structure such as anchoring side chain and neighboring hydroxy group conformations [14,15].

Given the unique potential of the SF₅ group, the rarity of its application in medicinal or agrochemical materials may be

surprising. However, synthesis of aliphatic SF₅-containing building blocks (SF₅-substituted aromatic compounds are more accessible) [1,6], is challenging and often beset by confusing reactivity, largely because of the very properties that make SF₅ an attractive substituent. Studies of aliphatic compounds have lagged as a consequence, a fact that is compounded by the lack of commercially available aliphatic SF₅-containing building blocks. Although the number of known aliphatic pentafluorosulfanylated compounds is constantly increasing [2], this expansion has not generally been accompanied by applications of these materials. Among aliphatic SF₅-substituted compounds α -pentafluorosulfanylated aliphatic carbonyl compounds [16], readily prepared from the corresponding enol acetates or enol ethers, are especially valuable as starting materials [17-22]. In these compounds the profound steric influence of the SF₅ group [14,15] is accompanied by a dramatic increase in the acidity of the adjacent α -proton, a phenomenon underlying the abstraction of protons by methyllithium and a number of different ylides [16]. The reactions of α -pentafluorosulfanyl carbonyl compounds are governed by a combination of the substantial dipole moment and unique steric effects of the octahedral SF₅ group. Aliphatic SF₅-containing derivatives of biologically active compounds are not well-known. One exception is the inclusion of an ω -SF₅-substituted amino acid incorporated at the crucial first and fourth positions of a heptapeptide [23]. When introduced at these positions, the SF₅-substituted amino acid had a strong propensity to direct α -helix formation of even this short heptapeptide presumably by minimization of unfavourable hydrophobic interactions.

Results and Discussion

The use of fluoroalkylimines to form β -lactams has proven especially useful in synthesis [24-26] especially in the Ojima β -lactam synthon method [27-29] used to prepare docetaxel analogs [26]. The general utility of the familiar Staudinger reaction of imines to transform readily accessible aldehydes to β -lactams has been well reviewed [30-33], yet in spite of this familiarity, the mechanism of this process remains a topic of interest [34-36].

Previously, it has been shown that fluorinated imines can undergo a manifold of reactions that are difficult to access with fluorinated aldehydes or ketones [37-40]. While there are many reports of the utility of trifluoroacetaldimines [41-44], there is only a single report of the preparation of *N*-ethyl 3,3,3-trifluoropropanaldimine [45], the trifluoromethyl analog of pentafluorosulfanylacetaldehyde (**1a**). The imine (3,3,3-trifluoropropanaldimine), in combination with the isomeric trifluoropropanamine, was not formed by the condensation of an amine with the aldehyde but rather by addition of an amine to 3,3,3-trifluoropropene. The imine was described as “extremely

unstable” [45] with no selective reactions reported. In light of this precedence the reaction of α -SF₅-substituted aldehydes and ketones with amines was particularly intriguing.

α -SF₅-Substituted aldehydes and ketones

In this work the SF₅-bearing aldehyde **1** was prepared by the addition of SF₅Cl to the enol ether **2** instead of the previously described additions to enol acetates [16] (Scheme 1). In earlier studies, it was found that the yield of SF₅Cl addition to enol acetates was highly dependent upon the purity of the enol acetate substrate, compounds surprisingly difficult to purify. Since vinyl acetate is the only enol acetate readily accessible for this reaction, the commercial availability of high purity propenyl and butenyl ethers **2b** and **2c** rendered these starting materials highly attractive for the formation of SF₅-bearing aldehydes.

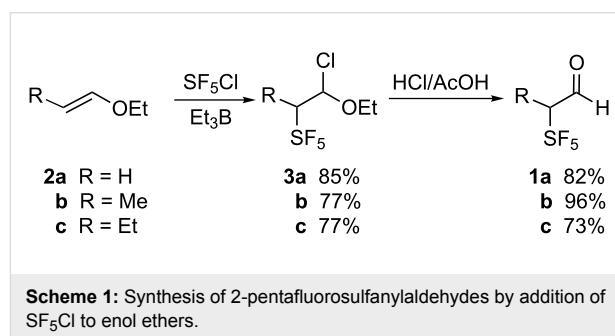

After addition of SF₅Cl to **2**, intermediate **3** was typically formed as a 9:1 mixture of diastereomers. Hydrolysis of **3** was easily followed by ¹⁹F NMR, e.g., the resonance for **3b** appeared approximately 7 ppm upfield from that of the aldehyde **1b**. The *J*_{H,F} coupling constant of 5.0 Hz contrasts with the *J*_{F_{eq},F_{ax}} value of 144 Hz.

The ready availability of the α -pentafluorosulfanyl carbonyl compounds facilitated an effort to dramatically expand the utility of these intriguing materials by synthesis and characterization of the corresponding pentafluorosulfanylated β -lactams.

α -SF₅-Substituted aldimines and ketimines

The aldehydes **1** were readily converted to the corresponding imine **5** in dichloromethane using anhydrous magnesium sulfate as a dehydrating agent (Scheme 2). Other desiccants, especially inherently basic materials, such as potassium carbonate lead to little imine formation. While the crude imine solution likely contained unreacted amine, attempted separation by silica gel chromatography led to extensive decomposition. The product imine consisted of a single stereoisomer as determined by ¹⁹F NMR, tentatively assigned as the *E*-isomer. Similar to the formation of **1**, it was easy to follow formation of the imine by

^{19}F NMR with the resonance attributed to the equatorial fluorines of the imine **5a** (δ 68.8 ppm) appearing upfield of those assigned to the aldehyde **1a** (δ 72.4 ppm). In the case of imines **5b–d**, the solution also contained between 15–20% of the putative enamine **6b–d**, where, for example, the equatorial fluorine resonances of **6b** appeared at δ 65.5 ppm in contrast to those of **5b** that appeared at δ 59.5 ppm. The tendency for the enamine resonances to appear downfield of imine resonances was confirmed by the preparation of the morpholine enamine of **1a** for which the equatorial fluorine resonance is also shifted downfield [46]. As mentioned above, the preparation of *N*-ethyl 3,3,3-trifluoropropanalimine, the Schiff base of 3,3,3-trifluoropropanal, was accompanied by enamine formation, likely as a consequence of the acidity of the proton α to the trifluoromethyl group [45,47]. Not surprisingly, **5** was relatively reactive. After careful filtration of the desiccant, the dichloromethane solution of the imine was used in further reactions without purification or separation of unreacted amine or the enamine side product.

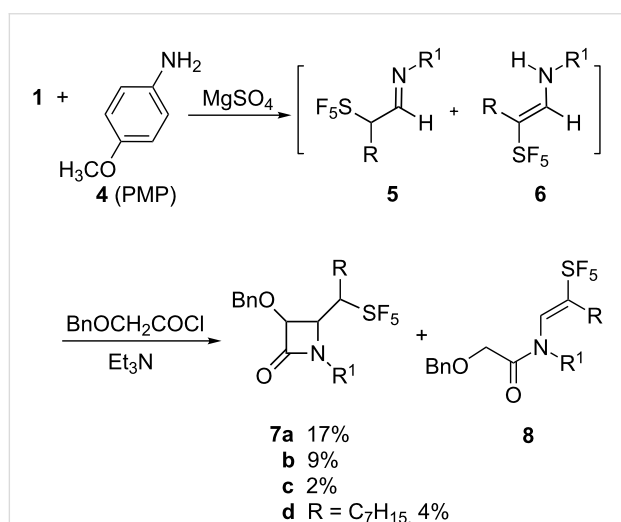

Scheme 2: Reaction of pentafluorosulfanylaldimines with benzyloxyketene.

Ketene imine cycloaddition reactions of α -SF₅-substituted aldimines and ketimines

Dropwise addition of the crude dichloromethane solution of **5** to benzyloxyacetyl chloride and triethylamine in dichloromethane was completed at 0 °C. The solution was then allowed to warm to room temperature with stirring overnight. Not surprisingly, the use of the crude solution of the imine led to the formation of a complex mixture where the desired product β -lactam **7** was a minor constituent. However, the yields of **7** are of product purified by silica gel chromatography and crystallization. The only other fluorinated products observed prior to purification were unreacted imine **5** and the tentatively designated *N*-acyl-

enamine **8**. In the case of **7b–d** the de of the 1,2-*lk* to 1,2-*ul* products was 76%, 84% and 50% respectively. The relative proportion of the product mixture that was comprised of enamine **8b–d** was 10%, 4% and 21% respectively.

In an effort to improve the reaction, the addition of triethylamine to a solution of the acid chloride and imine **5** resulted only in decomposition. Excess amine **4** that was present was acylated by benzyloxyacetyl chloride to form the corresponding amide.

The utility of the ketene–imine cyclization was not limited to aldimines. The addition of SF₅Br to the enol acetate of ethyl pyruvate **9** formed ethyl pentafluorosulfanylpyruvate **11** (Scheme 3). The ketimine **12**, prepared via amine condensation with **11**, was reacted as described for the aldimines **5** to form the desired β -lactam **7e**.

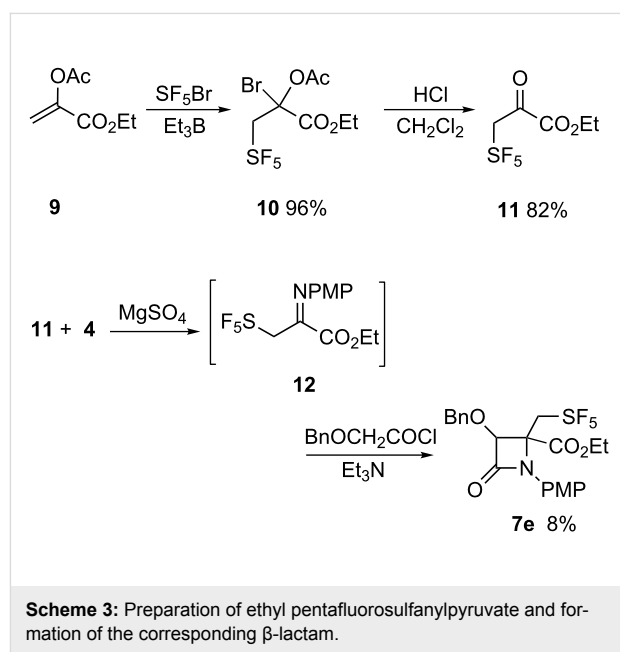

Formation of **7e** was accompanied by significantly greater decomposition of **12** and hence **7e** was formed in lower overall yields. In contrast to the stereoselective formation of **7b–d**, the diastereoselectivity of the Staudinger reactions as determined by ^{19}F NMR was dramatically reduced for **7e** to a de of 14%, a value consistent with the *Z/E* ratio for **12** of 0.7. While the isolated yields of purified **7b–e** are especially modest, the reaction conditions have not been optimized. But the significance of these findings lies not only in the difference in reactivity in comparison with trifluoropropanalimine but also in the relative diastereoselectivity of the ketene–imine cycloaddition reaction in comparison with the other reactions of SF₅-bearing aldehydes [16].

Structural characterization of SF₅-containing β-lactams

Isolated as a single diastereomer, the relative stereochemistry of **7a**, the product of the Staudinger reaction of **5a**, is shown in Figure 1. The *cis* relative stereochemistry of β-lactam is consistent with 1,2-*lk* conrotatory ring closure of the *E*-imine **5a** as would be predicted for a reaction with the Bose–Evans ketene formed from benzyloxyacetyl chloride [30]. The low yield of β-lactam product is better understood when the reactivity of the intermediate pentafluorosulfanylated imine and the subsequently formed iminium ion are considered. The SF₅ group increases the acidity of the α-proton of the imine **5** and of the iminium ion intermediate **B** formed on the initial nucleophilic attack of the imine on the ketene as illustrated in Scheme 4. The ring closure step requires bond formation between the iminium ion carbon and the enolate carbon **B** to be particularly facile for the stereoselectivity of the process to be preserved. The ring closure process must compete successfully with loss of the acidic proton from **B** to form **8** [16]. Another indication of the rapidity of ring closure is the failure to detect the 1,2-*ul* product. The absence of 1,2-*ul* product is consistent with retardation the rate of *E/Z* imine isomerization by the electron withdrawing pentafluorosulfanyl group [35]. In the reaction of **12**, the *E/Z* ratio of the imine was reflected very well in the 1,2-diastereomeric excess of the product β-lactam **7e**.

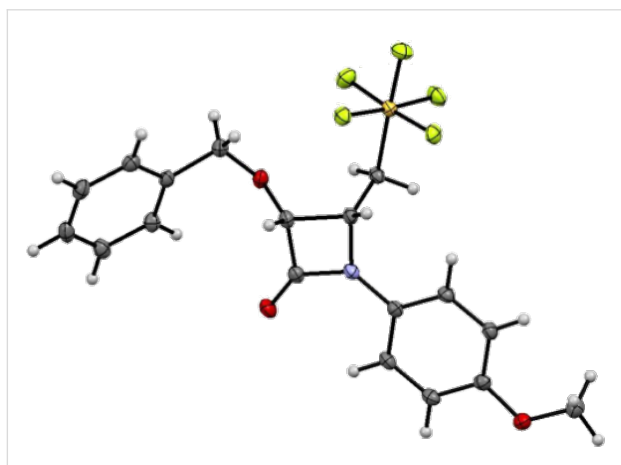
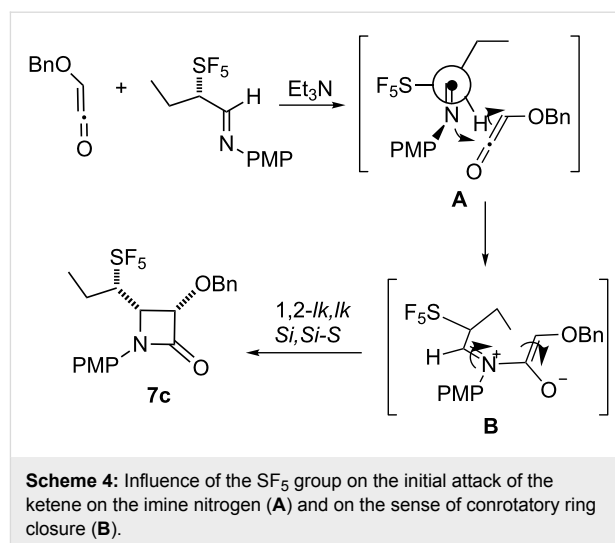

Figure 1: The 1,2-*lk* stereochemistry of **7a** as determined by single crystal X-ray diffraction. Thermal ellipsoids are set at 50% probability.

The ketene–imine condensation of **7c** is influenced by the presence of the pentafluorosulfanyl group at a stereogenic center. The 1,2-*lk, lk* (*Si, Si-S*) (or *Re, Re-R*) stereochemistry of **7c** (Figure 2) suggests the profound dipole associated with the introduction of the SF₅ group may influence the diastereoselectivity of ring closure. The initial approach of the ketene (**A** in Scheme 4) appears to be influenced by avoidance of unfavorable interaction of the ketene with the sterically demanding SF₅



Scheme 4: Influence of the SF₅ group on the initial attack of the ketene on the imine nitrogen (**A**) and on the sense of conrotatory ring closure (**B**).

group. Previously it was found in single crystal X-ray diffraction studies that the pentafluorosulfanyl group [48] is predictably orthogonal to a carbonyl group as shown in **A**. Cornforth control of the ring closure step of the zwitterion (**B** in Scheme 4) where the SF₅ would be antiperiplanar to the iminium ion would lead to the observed diastereoselectivity (Scheme 1). This finding is consistent with dipolar effects being most important in reactions with highly charged transition states such as **B**.

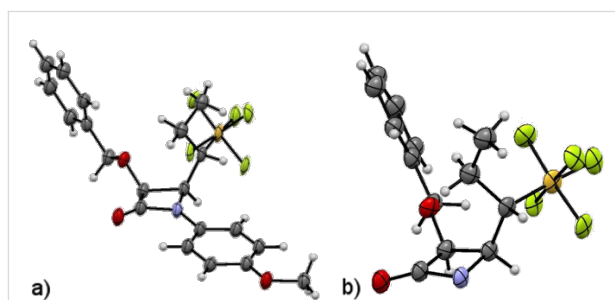

Figure 2: The stereochemistry of **7c**, 1,2-*lk, lk* (*Si, Si-S*), as determined by single crystal X-ray diffraction studies. Thermal ellipsoids are set at 50% probability. (a) Complete structure of **7c**. (b) PMP protecting group hidden for clarity.

In both structures, consistent with the opposing dipole geometry of the Cornforth transition state, the N–C–C–S torsional angles remain near 170° (169° and 167° for **7a** and **7c** respectively).

The 1,2-*lk, ul* ring closure product may be formed in the reaction of **5c** with benzyloxyketene and simply remain undetected, but it is clear that the control of diastereofacial selectivity in the formation of the principal β-lactam is strongly under the control of the SF₅ group.

Conclusion

Low molecular weight pentafluorosulfanylated aldehydes **1** were prepared by addition of SF₅Cl to enol ethers and the subsequent acidic hydrolysis of **3**. Formation of Schiff base **5** is problematic but, in contrast to the reactions of the analogous trifluoromethyl compounds, does successfully proceed. Even with a manifold of possible side reactions, β-lactam formation by the ketene–imine cycloaddition reaction of **5** occurs, albeit in very modest yields. The 1,2-*lk* stereochemistry of the β-lactam **7** was consistent with rapid cyclization and a failure of the imines **5** to isomerize. The presence of a pentafluorosulfanylated stereogenic carbon as in **5c**, apparently also influences the 2,3-*lk* stereochemistry. Optimization of β-lactam synthesis will require a better understanding of the nature of the competing, undesirable reactions and enable utilization of this unique construct in further synthetic transformations. The product β-lactams are a useful entrée to the diastereoselective synthesis of pentafluoro-sulfanyl β-amino acids and suggest a path to the preparation of more extensively functionalized SF₅-containing β-lactams.

Supporting Information

Supporting Information File 1

Detailed experimental procedures and spectroscopic data for **1a–e**, **10**, **5a–d**, **7a–e** and **11**.

[<http://www.beilstein-journals.org/bjoc/content/supplementary/1860-5397-9-303-S1.pdf>]

Supporting Information File 2

X-ray crystallographic data for **7a** and **7c**, CCDC 937908 and 937909.

[<http://www.beilstein-journals.org/bjoc/content/supplementary/1860-5397-9-303-S2.cif>]

Acknowledgements

We thank Dr. Jin-hong Lin for his assistance in preparing **11**. We gratefully acknowledge National Science Foundation (CHE0957544) for financial support of this work.

References

- Welch, J. T. Applications of pentafluorosulfanyl substitution in life sciences research. In *Fluorine in Pharmaceutical and Medicinal Chemistry*; Gouverneur, V.; Müller, K., Eds.; Imperial College Press: London, 2012; pp 175–207.
- Altomonte, S.; Zanda, M. *J. Fluorine Chem.* **2012**, *143*, 57–93. doi:10.1016/j.jfluchem.2012.06.030
- Lentz, D.; Seppelt, K. The –SF₅, –SeF₅, and –TeF₅ groups in organic chemistry. In *Chemistry of Hypervalent Compounds*; Akiba, K.-y., Ed.; Wiley-VCH: New York, 1999; pp 295–323.
- Winter, R. W.; Dodean, R. A.; Gard, G. L. SF₅ synthons: Pathways to organic derivatives of SF₆. In *Fluorine-Containing Synthons*; Soloshonok, V. A., Ed.; American Chemical Society: Washington, D. C., 2005; pp 87–118. doi:10.1021/bk-2005-0911.ch004
- Gard, G. L. *Chim. Oggi* **2009**, *27*, 10–13.
- Kirsch, P. *Modern Fluoroorganic Chemistry. Synthesis, Reactivity and Applications*; Wiley-VCH: Weinheim, Germany, 2004. doi:10.1002/352760393X
- Brant, P.; Berry, A. D.; DeMarco, R. A.; Carter, F. L.; Fox, W. B.; Hashmall, J. A. *J. Electron Spectrosc. Relat. Phenom.* **1981**, *22*, 119–129. doi:10.1016/0368-2048(81)80021-7
- True, J. E.; Thomas, T. D.; Winter, R. W.; Gard, G. L. *Inorg. Chem.* **2003**, *42*, 4437–4441. doi:10.1021/ic0343298
- Sæthre, L. J.; Berrah, N.; Bozek, J. D.; Børve, K. J.; Carroll, T. X.; Kukk, E.; Gard, G. L.; Winter, R.; Thomas, T. D. *J. Am. Chem. Soc.* **2001**, *123*, 10729–10737. doi:10.1021/ja016395j
- Sheppard, W. A. *J. Am. Chem. Soc.* **1962**, *84*, 3072–3076. doi:10.1021/ja00875a007
- Taft, R. W., Jr.; Lewis, I. C. *J. Am. Chem. Soc.* **1959**, *81*, 5343–5352. doi:10.1021/ja01529a025
- Taft, R. W., Jr. *J. Phys. Chem.* **1960**, *64*, 1805–1815. doi:10.1021/j100841a003
- Anthony, M. *Aust. N. Z. J. Med.* **1984**, *14*, 888–895. doi:10.1111/j.1445-5994.1984.tb03802.x
- Savoie, P. R.; Higashiya, S.; Lin, J.-H.; Wagle, D. V.; Welch, J. T. *J. Fluorine Chem.* **2012**, *143*, 281–286. doi:10.1016/j.jfluchem.2012.06.027
- Savoie, P. R.; Welch, J. M.; Higashiya, S.; Welch, J. T. *J. Fluorine Chem.* **2013**, *148*, 1–5. doi:10.1016/j.jfluchem.2013.01.013
- Ngo, S. C.; Lin, J.-H.; Savoie, P. R.; Hines, E. M.; Pugliese, K. M.; Welch, J. T. *Eur. J. Org. Chem.* **2012**, 4902–4905. doi:10.1002/ejoc.201200763
- Winter, R.; Gard, G. L. *J. Fluorine Chem.* **1994**, *66*, 109–116. doi:10.1016/0022-1139(93)03005-7
- Ray, N. H. *J. Chem. Soc.* **1963**, 1440–1441. doi:10.1039/JR9630001440
- Kleemann, G.; Seppelt, K. *Chem. Ber.* **1979**, *112*, 1140–1146. doi:10.1002/cber.19791120409
- Dolbier, W. R., Jr.; Ait-Mohand, S.; Schertz, T. D.; Sergeeva, T. A.; Cradlebaugh, J. A.; Mitani, A.; Gard, G. L.; Winter, R. W.; Thrasher, J. S. *J. Fluorine Chem.* **2006**, *127*, 1302–1310. doi:10.1016/j.jfluchem.2006.05.003
- Coffman, D. D.; Tullock, C. W. Carbonylic compounds containing the SF₅ function. U.S. Patent US3,102,903, Sept 3, 1963.
- Winter, R.; Willett, R. D.; Gard, G. L. *Inorg. Chem.* **1989**, *28*, 2499–2501. doi:10.1021/ic00311a054
- Lim, D. S.; Lin, J.-H.; Welch, J. T. *Eur. J. Org. Chem.* **2012**, 3946–3954. doi:10.1002/ejoc.201200327
- Abouabdellah, A.; Bégué, J.-P.; Bonnet-Delpon, D.; Thanh Nga, T. T. *J. Org. Chem.* **1997**, *62*, 8826–8833. doi:10.1021/jo971381a
- Petrik, V.; Röschenhaler, G.-V.; Cahard, D. *Tetrahedron* **2011**, *67*, 3254–3259. doi:10.1016/j.tet.2011.03.001
- Pepe, A.; Kuznetsova, L.; Sun, L.; Ojima, I. Fluoro-taxoid anticancer agents. In *Fluorine in Medicinal Chemistry and Chemical Biology*; Ojima, I., Ed.; John Wiley & Sons Ltd.: Chichester, 2009; pp 117–139. doi:10.1002/9781444312096.ch5
- Ojima, I. β-Lactam synthon method: enantiomerically pure β-lactams as synthetic intermediates. In *Organic Chemistry of β-lactams*; Georg, G. I., Ed.; VCH: New York, NY, 1993; pp 197–255.

28. Kamath, A.; Ojima, I. *Tetrahedron* **2012**, *68*, 10640–10664. doi:10.1016/j.tet.2012.07.090
29. Ojima, I.; Zuniga, E. S.; Seitz, J. D. *Top. Heterocycl. Chem.* **2013**, *30*, 1–63. doi:10.1007/77081_2012_86
30. Georg, G. I.; Ravikumar, V. T. Stereocontrolled ketene-imine cycloaddition reactions. In *Organic Chemistry of β -lactams*; Georg, G. I., Ed.; VCH: New York, NY, 1993; pp 295–368.
31. Palomo, C.; Aizpurua, J. M.; Ganboa, I.; Oiarbide, M. *Eur. J. Org. Chem.* **1999**, 3223–3235. doi:10.1002/(SICI)1099-0690(199912)1999:12<3223::AID-EJOC3223>3.0.CO;2-1
32. Palomo, C.; Aizpurua, J. M.; Ganboa, I.; Oiarbide, M. *Curr. Med. Chem.* **2004**, *11*, 1837–1872. doi:10.2174/0929867043364900
33. Thompson, S.; Coyne, A. G.; Knipe, P. C.; Smith, M. D. *Chem. Soc. Rev.* **2011**, *40*, 4217–4231. doi:10.1039/c1cs15022g
34. Cossio, F. P.; Arrieta, A.; Sierra, M. A. *Acc. Chem. Res.* **2008**, *41*, 925–936. doi:10.1021/ar800033j
35. Jiao, L.; Liang, Y.; Xu, J. J. *Am. Chem. Soc.* **2006**, *128*, 6060–6069. doi:10.1021/ja056711k
36. Xu, J. *Tetrahedron* **2012**, *68*, 10696–10747. doi:10.1016/j.tet.2012.04.007
37. Fustero, S.; Jiménez, D.; Sanz-Cervera, J. F.; Sánchez-Roselló, M.; Esteban, E.; Simón-Fuentes, A. *Org. Lett.* **2005**, *7*, 3433–3436. doi:10.1021/ol050791f
38. Zanda, M.; Bravo, P.; Volonterio, A. Stereoselective synthesis of β -fluoroalkyl β -amino alcohol units. In *Asymmetric Fluoroorganic Chemistry*; Ramachandran, P. V., Ed.; American Chemical Society: Washington, D.C., 2000; Vol. 746, pp 127–141. doi:10.1021/bk-2000-0746.ch010
39. Welch, J. T.; De Corte, B.; De Kimpe, N. *J. Org. Chem.* **1990**, *55*, 4981–4983. doi:10.1021/jo00304a002
40. Welch, J. T.; Seper, K. W. *J. Org. Chem.* **1988**, *53*, 2991–2999. doi:10.1021/jo00248a017
41. Carroccia, L.; Fioravanti, S.; Pellacani, L.; Tardella, P. A. *Synthesis* **2010**, 4096–4100. doi:10.1055/s-0030-1258280
42. Nie, J.; Guo, H.-C.; Cahard, D.; Ma, J.-A. *Chem. Rev.* **2011**, *111*, 455–529. doi:10.1021/cr100166a
43. Magueur, G.; Legros, J.; Meyer, F.; Ourévitich, M.; Crousse, B.; Bonnet-Delpon, D. *Eur. J. Org. Chem.* **2005**, 1258–1265. doi:10.1002/ejoc.200400719
44. Crousse, B.; Narizuka, S.; Bonnet-Delpon, D.; Bégué, J.-P. *Synlett* **2001**, 679–681. doi:10.1055/s-2001-13364
45. Stepanova, N. P.; Lebedev, V. B.; Orlova, N. A.; Turbanova, E. S.; Petrov, A. A. *Zh. Org. Khim.* **1988**, *24*, 692–699.
46. Welch, J. T.; Penger, A. unpublished results.
47. Yamazaki, T.; Kobayashi, R.; Kitazume, T.; Kubota, T. *J. Org. Chem.* **2006**, *71*, 2499–2502. doi:10.1021/jo052434o
48. Welch, J. T.; Zhong, L.; Filatov, A. S. unpublished results.

License and Terms

This is an Open Access article under the terms of the Creative Commons Attribution License (<http://creativecommons.org/licenses/by/2.0>), which permits unrestricted use, distribution, and reproduction in any medium, provided the original work is properly cited.

The license is subject to the *Beilstein Journal of Organic Chemistry* terms and conditions: (<http://www.beilstein-journals.org/bjoc>)

The definitive version of this article is the electronic one which can be found at: [doi:10.3762/bjoc.9.303](https://doi.org/10.3762/bjoc.9.303)

One-pot cross-enyne metathesis (CEYM)–Diels–Alder reaction of *gem*-difluoropropargylic alkynes

Santos Fustero^{*1,2}, Paula Bello¹, Javier Miró¹, María Sánchez-Roselló^{1,2},
Günter Haufe³ and Carlos del Pozo^{*1}

Full Research Paper

Open Access

Address:

¹Departamento de Química Orgánica, Universidad de Valencia, E-46100 Burjassot, Spain, ²Laboratorio de Moléculas Orgánicas, Centro de Investigación Príncipe Felipe, E-46012 Valencia, Spain and ³Organisch-Chemisches Institut, Westfälische Wilhelms-Universität, Corrensstraße 40, D-48149 Münster, Germany

Email:

Santos Fustero^{*} - santos.fustero@uv.es; Carlos del Pozo^{*} - carlos.pozo@uv.es

^{*} Corresponding author

Keywords:

cross metathesis; Diels–Alder; one-pot reaction; organo-fluorine; propargylic difluorides

Beilstein J. Org. Chem. **2013**, *9*, 2688–2695.

doi:10.3762/bjoc.9.305

Received: 01 September 2013

Accepted: 06 November 2013

Published: 28 November 2013

This article is part of the Thematic Series "Organo-fluorine chemistry III".

Guest Editor: D. O'Hagan

© 2013 Fustero et al; licensee Beilstein-Institut.

License and terms: see end of document.

Abstract

Propargylic difluorides **1** were used as starting substrates in a combination of cross-enyne metathesis and Diels–Alder reactions. Thus, the reaction of **1** with ethylene in the presence of 2nd generation Hoveyda–Grubbs catalyst generates a diene moiety which in situ reacts with a wide variety of dienophiles giving rise to a small family of new fluorinated carbo- and heterocyclic derivatives in moderate to good yields. This is a complementary protocol to the one previously described by our research group, which involved the use of 1,7-octadiene as an internal source of ethylene.

Introduction

In recent years the number of applications of olefin metathesis as a mild and competitive synthetic method for the creation of carbon–carbon bonds has exponentially increased, due to the availability of well-defined catalysts [1-3]. Particularly, enyne metathesis (EYM) is a powerful synthetic tool for generating 1,3-dienes by redistributing unsaturated functionalities between an alkene and an alkyne moiety via vinylalkylidene intermediates [4-6]. This is an atom economical process since it is an addition reaction and non-olefin byproducts are formed.

Furthermore, a sequential use of EYM and Diels–Alder reactions generates highly functionalized carbo- and heterocyclic frameworks [7-11].

The intramolecular version of this process, the ring closing enyne metathesis (RCEYM) reaction, has found wide application, and several examples can be found in the literature [12,13]. However, the intermolecular version, i.e. the cross-enyne metathesis (CEYM) reaction, has been much less

exploited probably due to its inherent problems of selectivity, which results in the formation of a mixture of *E*- and *Z*-isomers [14]. The discovery of the beneficial effect of ethylene has changed this tendency allowing the straightforward preparation of 1,3-dienes [15,16]. Thus, during the ethylene gas promoted CEYM reaction, ethylene does not incorporate into the product but intercepts the secondary metathesis pathways avoiding the formation of secondary products during the process [17,18].

Among organic fluorine compounds, propargylic fluorides constitute a relevant class of fluorinated building blocks. The transformational diversity of the alkynyl group converts them into versatile synthetic intermediates. Additionally, propargylic fluorides are prevalent motifs in life sciences, such as medicinal chemistry or crop protection. In this context, the preparation of monofluorinated propargylic compounds has been the subject of intense research, and efficient methodologies to access these derivatives have been devised [19,20]. However, the analogues bearing the *gem*-difluoro moiety next to unsaturated bonds have not received comparable attention, probably due to the limited availability of the starting materials. In this context, the recent introduction of difluoropropargyl bromide as fluorinated building block gave access to a wide variety of *gem*-difluoro-containing alkyne derivatives [21,22]. Recently, we have employed these fluorinated triple bond scaffolds in several types of cyclization reactions for the preparation of different difluoropropargylamides and ketones, having been subjected to intramolecular hydroaminations [23], cascade RCEYM–Diels–Alder reactions [24], [2 + 2 + 2] cycloadditions and gold-mediated dimerization reactions [25].

Although the CEYM reaction has been found to be very fruitful for the preparation of 1,3-dienes, this protocol has remained almost unexplored for propargyl fluorides [26]. In this context, we have recently established a tandem multicomponent protocol CEYM–Diels–Alder reaction of several difluoropropargylic derivatives [27,28] mediated by 1,7-octadiene as an internal source of ethylene [29]. Following our ongoing interest in the use of these fluorinated building blocks, we decided to evaluate the CEYM reaction of several difluoropropargylamides and ketones in combination with a Diels–Alder reaction under Mori's conditions, in order to compare this protocol with the aforementioned one (Scheme 1).

Results and Discussion

In order to prove the efficiency of ethylene-mediated cross-enyne metathesis on our fluorinated alkynes, substrate **1a** was chosen as a model substrate. As expected, when a toluene solution of alkyne **1a** and 5 mol % of 2nd generation Hoveyda–Grubbs catalyst **I** was heated under ethylene atmosphere (1 atm) for 2 h, the clean formation of diene **2a** was

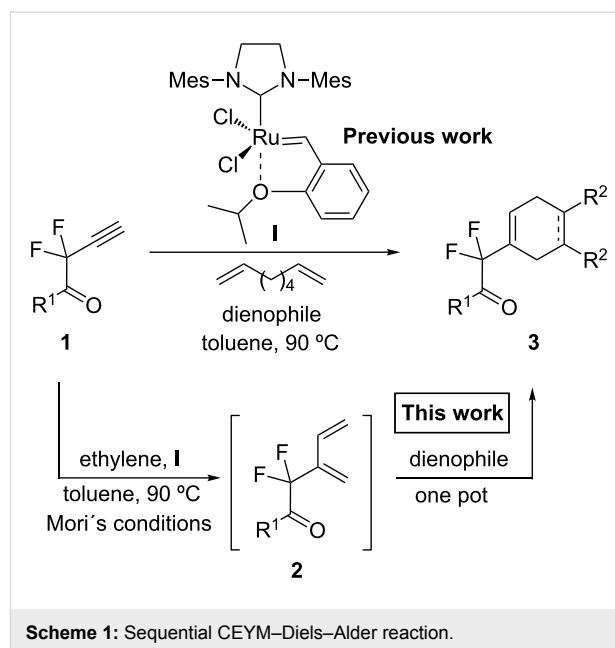

observed. This newly formed diene was isolated in 70% yield and it reacted smoothly with 4-phenyl-3*H*-1,2,4-triazole-3,5(4*H*)-dione as dienophile at room temperature to afford, after chromatographic purification, the corresponding Diels–Alder adduct **3a** in 60% yield (Scheme 2). It was interesting to find that this sequence can be performed as a one-pot procedure. Thus, when the formation of the diene intermediate **2a** was completed (determined by TLC), the dienophile was added to the reaction mixture and was allowed to react for two additional hours. Flash chromatography of the crude product afforded the desired tandem derivative **3a** in 60% overall yield (Scheme 2).

Next, the one-pot protocol was extended to other starting difluoropropargylic alkynes and dienophiles, affording a new family of carbo- and heterocyclic derivatives in moderate to good yields (Table 1).

A wide variety of nucleophiles is compatible with the one-pot protocol (Table 1, method A, entries 1–6). Ethyl fumarate gave the desired product **3b** in 55% yield (Table 1, method A, entry 2). It is interesting to point out that diethyl acetylenedicarboxylate (DEAD) afforded adduct **3c** in 51% yield, and no aromatization was observed during the process (Table 1, method A, entry 3). When maleic anhydride was used as dienophile, the corresponding diacid **3f**, arising from the anhydride ring opening under the reaction conditions, was observed as the major product (Table 1, method A, entries 6 and 9). With chiral starting material **1b**, in all cases a 1:1 mixture of diastereoisomers was obtained which could not be separated. This indicates that the chiral information is not close enough to the reacting

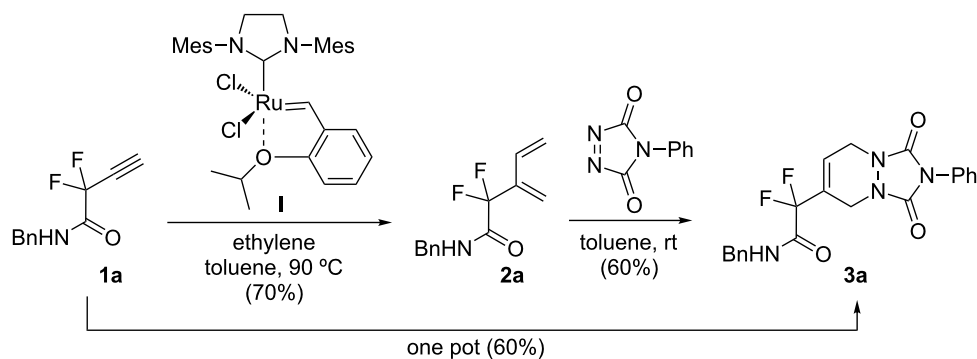

Scheme 2: One-pot CM-Diels-Alder reaction with fluorinated alkyne **1a**.

Table 1: Preparation of compounds **3** by one-pot CEYM-Diels-Alder reaction of substrates **1** (method A).

entry	1	R ¹	dienophile	product	% yield method A ^a (time, h)	% yield method B ^b (time, h)
1	1a	Bn-NH			60 (2 h) ^c	–
2	1a	Bn-NH			55 (8 h)	70 (20 h)
3	1a	Bn-NH			51 (6 h)	55 (6 h)
4	1a	Bn-NH			50 (4 h)	63 (24 h)

Table 1: Preparation of compounds **3** by one-pot CEYM–Diels–Alder reaction of substrates **1** (method A). (continued)

5	1a	Bn–NH			47 (24 h)	50 (24 h)
6	1a	Bn–NH			85 (120 h) ^c	–
7	1b	(<i>R</i>)-Ph(Me)–CHNH		 + 	87 (4 h) ^d	73 (24 h) ^d
8	1b	(<i>R</i>)-Ph(Me)–CHNH		 + 	74 (2 h) ^d	70 (10 h) ^d
9	1b	(<i>R</i>)-Ph(Me)–CHNH		 + 	74 (20 h) ^{c,d}	–

Table 1: Preparation of compounds **3** by one-pot CEYM–Diels–Alder reaction of substrates **1** (method A). (continued)

10	1b	(<i>R</i>)-Ph(Me)–CHNH			63 (10 h)	60 (24 h)
11	1c	PropylNH			40 (5 h)	–
12	1d	Ph			48 (4 h)	55 (15 h)
13	1d	Ph			28 (8 h)	–
14	1d	Ph			58 (12 h)	70 (17 h)
15	1e	Cy			54 (12 h)	–

^aMethod A: One-pot protocol with Mori's conditions. The formation of the corresponding diene **2** with ethylene was complete after 2 h at 90 °C for all substrates. ^bMethod B: Tandem multicomponent protocol mediated by 1,7-octadiene [29]. ^cWhen maleic anhydride or 4-phenyl-3*H*-1,2,4-triazole-3,5(4*H*)-dione were used as dienophiles, the Diels–Alder reaction was performed at rt. With maleic anhydride final products were isolated as the corresponding diacid derivatives. ^dIn all cases, adducts were obtained as an inseparable 1:1 mixture of diastereoisomers.

centre (Table 1, method A, entries 7–10). Finally, fluorinated ketones could also be used as substrates for the sequential process (Table 1, method A, entries 12–15) and again with alkynes as dienophiles, no aromatization of the final products was detected (Table 1, method A, entry 12).

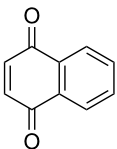
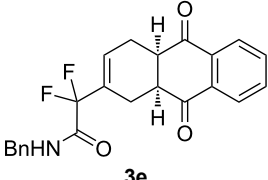
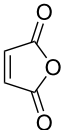
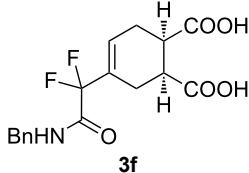
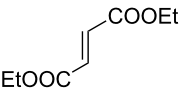
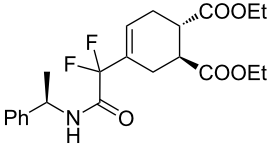
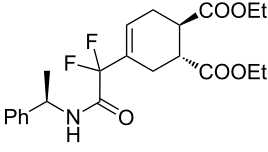
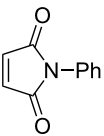
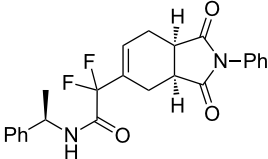
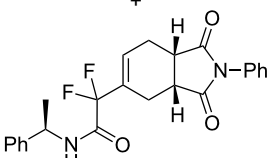
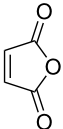
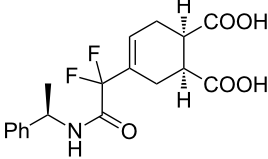
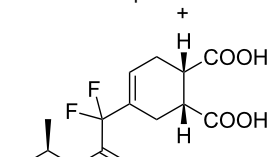
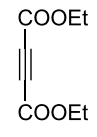
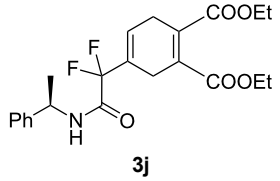
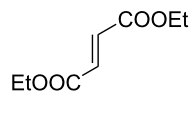
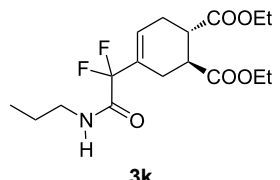
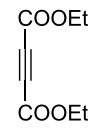
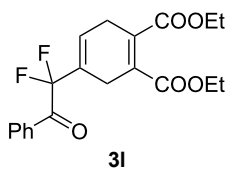
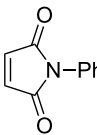
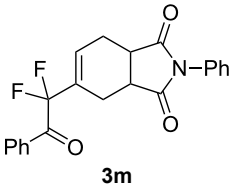
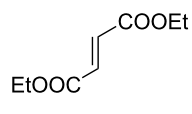
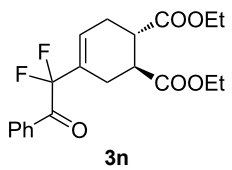
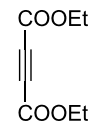
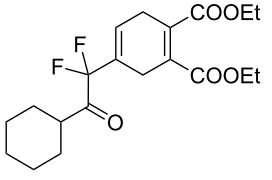
The yields that appear in Table 1 in the last column (method B) represent the reaction performed under the tandem-multicomponent conditions mediated by 1,7-octadiene (Scheme 1). In general, yields are comparable using either methodology, indicating that they are applicable for the synthesis of new carbo-

and heterocyclic derivatives bearing a *gem*-difluoro moiety in an efficient manner. However, at this point it is important to mention that when the 1,7-octadiene protocol was applied using maleic anhydride or 4-phenyl-3*H*-1,2,4-triazole-3,5(4*H*)-dione as dienophiles (Table 1, method B, entries 1, 6 and 9), a complex mixture was obtained. This is probably due to the fact that under those thermal conditions, it is not possible to use these types of dienophiles since they decompose while being heated. The sequential generation of the dienic intermediate **2** and the Diels–Alder reaction allow performing the second step at rt, avoiding these problems. Thus, although a tandem-multicompo-

nent protocol is more desirable, the use of the one-pot protocol expand the utility and scope of this methodology, since milder conditions can be employed in the cyclization step.

Conclusion

In conclusion, a tandem one-pot enyne-cross metathesis-Diels–Alder reaction of difluoropropargylic alkynes with a variety of dienophiles has been described. The process took place in moderate to good yields, giving rise to a new family of fluorinated carbo- and heterocyclic derivatives in a very simple manner. In comparison with the tandem multicomponent protocol, the one-pot sequence is a complementary methodology, since although comparable yields of the final adducts can be obtained, this methodology is compatible with a greater variety of dienophiles.

Experimental

General experimental methods. Reactions were carried out under argon atmosphere unless otherwise indicated. The solvents were purified prior to use: THF, diethyl ether and toluene were distilled from sodium/benzophenone; dichloromethane and acetonitrile were distilled from calcium hydride. The reactions were monitored with the aid of thin-layer chromatography (TLC) on 0.25 mm precoated silica gel plates. Visualization was carried out with UV light and aqueous ceric ammonium molybdate solution or potassium permanganate stain. Flash column chromatography was performed with the indicated solvents on silica gel 60 (particle size 0.040–0.063 mm). ^1H and ^{13}C NMR spectra were recorded on 300 or 400 MHz spectrometers. Chemical shifts are given in ppm (δ), with reference to the residual proton resonances of the solvents. Coupling constants (J) are given in Hertz (Hz). The letters m, s, d, t, and q stand for multiplet, singlet, doublet, triplet and quartet, respectively. The letters br indicate that the signal is broad. Starting fluorinated amides **1** [23–25] and compounds **3b,c,e,g,h,j,l,n** [29] were previously described.

General procedure for the one-pot process. Ethylene was bubbled through a solution of catalyst **I** (5 mol %) in dry toluene (2.4 mL) for 3 minutes at room temperature in a sealed tube. Substrate **1** (0.12–0.25 mmol) was added next and it was heated at 90 °C for 2 hours. Once the intermediate diene was formed (by TLC), it was cooled to room temperature and the corresponding dienophile was added. The reaction mixture was stirred at temperatures and times given in Table 1. Finally, after removal of solvents, the reaction mixture was purified by flash chromatography in hexanes/ethyl acetate (3:1).

***N*-Benzyl-2,2-difluoro-3-methylenepent-4-enamide (2a).** Following the procedure described above and before adding the dienophile, the crude mixture was subjected to flash chromatog-

raphy affording 41 mg of **2a** (70% yield) as a yellow oil starting from 52 mg of **1a**. ^1H NMR (CDCl_3 , 300 MHz) δ 4.52 (d, $J = 5.8$ Hz, 2H), 5.25 (d, $J = 11.3$ Hz, 1H), 5.52 (d, $J = 17.9$ Hz, 1H), 5.64 (d, $J = 15.9$ Hz, 2H), 6.32 (dd, $J_1 = 11.3$ Hz, $J_2 = 17.7$ Hz, 1H), 6.65 (br s, 1H), 7.26–7.39 (m, 5H); ^{13}C NMR (CDCl_3 , 300 MHz) δ 43.61, 114.40 (t, $^1J_{\text{CF}} = 253.2$ Hz), 118.17, 119.33 (t, $^3J_{\text{CF}} = 8.6$ Hz), 127.81, 127.93, 128.84, 131.02 (t, $^3J_{\text{CF}} = 2.3$ Hz), 136.75, 138.82 (t, $^2J_{\text{CF}} = 22.3$ Hz), 163.23 (t, $^2J_{\text{CF}} = 29.9$ Hz); ^{19}F NMR (CDCl_3 , 282 MHz) δ –105.57 (s, 2F); HRMS: $[\text{M} + 1]^+$ calcd for $\text{C}_{13}\text{H}_{14}\text{F}_2\text{NO}$, 238.1038; found, 238.1042.

***N*-Benzyl-2-(1,3-dioxo-2-phenyl-2,3,5,8-tetrahydro-1*H*-[1,2,4]triazolo[1,2*a*]pyridazin-6-yl)-2,2-difluoroacetamide (3a).** Following the general procedure described above, 61 mg of **3a** (60% yield) were obtained as a white solid starting from 52 mg of **1a**. mp = 148–150 °C; ^1H NMR (CDCl_3 , 300 MHz) δ 4.26–4.29 (m, 2H), 4.34 (s, 2H), 4.5 (d, $J = 5.7$ Hz, 2H), 6.46 (m, 1H), 6.86 (br s, 1H), 7.16–7.53 (m, 10H); ^{13}C NMR (CDCl_3 , 300 MHz) δ 41.8 (t, $^3J_{\text{CF}} = 4$ Hz), 43.1, 43.8, 113.3 (t, $^1J_{\text{CF}} = 253.8$ Hz), 123.7 (t, $^3J_{\text{CF}} = 8.7$ Hz), 125.4, 126.8 (t, $^2J_{\text{CF}} = 25.2$ Hz), 127.9, 128.2, 128.4, 129.0, 129.2, 130.8, 136.3, 152.3, 152.4, 162.2 (t, $^2J_{\text{CF}} = 29.9$ Hz); ^{19}F NMR (CDCl_3 , 282 MHz) δ –106.9 (s, 2F); HRMS: $[\text{M}]^+$ calcd for $\text{C}_{21}\text{H}_{18}\text{F}_2\text{N}_4\text{O}_3$, 412.1347; found, 412.1344.

Diethyl 4-(2-(benzylamino)-1,1-difluoro-2-oxoethyl)cyclohex-4-ene-1,2-dicarboxylate (3b). Following the general procedure described above, 30 mg (55% yield) of **3b** were obtained as a white solid starting from 26 mg of **1a**.

Diethyl 4-(2-(benzylamino)-1,1-difluoro-2-oxoethyl)cyclohexa-1,4-diene-1,2-dicarboxylate (3c). Following the general procedure described above, 52 mg (51% yield) of **3c** were obtained as a dark brown oil starting from 52 mg of **1a**.

***N*-Benzyl-2-(1,3-dioxo-2-phenyl-2,3,3a,4,7,7a-hexahydro-1*H*-isoindol-5-yl)-2,2-difluoroacetamide (3d).** Following the general procedure described above, 25 mg of **3d** (50% yield) were obtained as a dark brown oil starting from 26 mg of **1a**. ^1H NMR (CDCl_3 , 300 MHz) δ 2.32–2.47 (m, 2H), 2.82–2.93 (m, 2H), 3.27–3.38 (m, 2H), 4.46 (d, $J = 5.7$ Hz, 2H), 6.49–6.55 (m, 1H), 6.68 (br s, 1H), 7.27–7.47 (m, 10H); ^{13}C NMR (CDCl_3 , 300 MHz) δ 22.8, 23.9, 38.7, 39.1, 43.7, 114.2 (t, $^1J_{\text{CF}} = 251.0$ Hz), 126.5, 127.9, 128.0, 128.7, 128.9, 129.1, 129.9 (t, $^3J_{\text{CF}} = 8.9$ Hz), 131.8, 131.9 (t, $^2J_{\text{CF}} = 24.4$ Hz), 136.6, 162.8 (t, $^2J_{\text{CF}} = 30.1$ Hz), 177.7, 178.1; ^{19}F NMR (CDCl_3 , 282 MHz) δ –106.5 (d, $J_{\text{FF}} = 258.1$ Hz, 1F), –108.7 (d, $J_{\text{FF}} = 258.4$ Hz, 1F); HRMS: $[\text{M}]^+$ calcd for $\text{C}_{23}\text{H}_{20}\text{F}_2\text{N}_2\text{O}_3$, 410.1442; found, 410.1445.

***N*-Benzyl-2-(9,10-dioxo-1,4,4a,9,9a,10-hexahydroanthracen-2-yl)-2,2-difluoroacetamide (3e).** Following the general proce-

dure described above, 24 mg of **3e** (47% yield) were obtained as a dark brown oil starting from 26 mg of **1a**.

4-[2-(Benzylamino)-1,1-difluoro-2-oxoethyl]cyclohex-4-ene-1,2-dicarboxylic acid (3f). Following the general procedure described above, 71 mg of **3f** (85% yield) were obtained as a dark brown oil starting from 52 mg of **1a**. ^1H NMR (CDCl_3 , 300 MHz) δ 2.46–2.52 (m, 2H), 2.68–2.75 (m, 2H), 3.07 (m, 1H), 3.17 (m, 1H), 4.47 (d, $J = 5.7$ Hz, 2H), 6.21 (s, 1H), 6.80–6.84 (m, $J = 5.4$ Hz, 1H), 7.25–7.37 (m, 5H), 7.77 (br s, 2H); ^{13}C NMR (CDCl_3 , 300 MHz) δ 23.1, 25.0, 38.5, 38.9, 43.6, 114.8 (t, $^1J_{\text{CF}} = 251.1$ Hz), 127.8, 127.9, 128.8, 136.6, 163.6 (t, $^2J_{\text{CF}} = 30.6$ Hz), 178.3, 178.5; ^{19}F NMR (CDCl_3 , 282 MHz) δ -117.0 (d, $J_{\text{FF}} = 258.9$ Hz, 1F), -118.0 (d, $J_{\text{FF}} = 258.7$ Hz, 1F); HRMS: $[\text{M} + \text{Na}]^+$ calcd for $\text{C}_{17}\text{H}_{17}\text{F}_2\text{NO}_5$, 376.0972; found, 376.0969.

Diethyl 4-(1,1-difluoro-2-oxo-2-[(R)-1-phenylethylamino]ethyl)cyclohex-4-ene-1,2-dicarboxylate (3g + 3g'). Following the general procedure described above, 41 mg (87% yield) of an inseparable mixture of **3g** and **3g'** were obtained as a dark brown oil starting from 25 mg of **1b**.

2-(1,3-Dioxo-2-phenyl-2,3,3a,4,7,7a-hexahydro-1H-isoindol-5-yl)-2,2-difluoro-N-[(R)-1-phenylethyl]acetamide (3h + 3h'). Following the general procedure described above, 34 mg (74% yield) of an inseparable mixture of **3h** and **3h'** were obtained as a dark brown solid starting from 25 mg of **1b**.

4-[1,1-difluoro-2-oxo-2-((R)-1-phenylethylamino)ethyl]cyclohexa-4-ene-1,2-dicarboxylate (3i + 3i'). Following the general procedure described above, 24.3 mg of an inseparable mixture of **3i** and **3i'** were obtained as a dark brown oil starting from 25 mg of **1b**. ^1H NMR (CDCl_3 , 300 MHz) δ 1.53 (dd, $J = 6.9$ Hz, $J = 4.8$ Hz, 3H), 2.46–2.51 (m, 2H), 2.67–2.74 (m, 2H), 3.02–3.07 (m, 1H), 3.15–3.17 (m, 1H), 5.08–5.17 (m, 1H), 6.17 (d, $J = 13.5$ Hz, 1H), 6.63–6.68 (br m, 1H), 7.28–7.38 (m, 5H); ^{13}C NMR (CDCl_3 , 300 MHz) δ 21.2, 23.4, 25.2, 49.2, 114.7 (t, $^1J_{\text{CF}} = 255.0$ Hz), 126.1, 127.7, 128.7, 141.7, 162.5 (t, $^2J_{\text{CF}} = 30.7$ Hz), 177.6, 177.9; ^{19}F NMR (CDCl_3 , 282 MHz) δ -106.6 (d, $J_{\text{FF}} = 258.9$ Hz, 1F), -106.8 (d, $J_{\text{FF}} = 256.4$ Hz, 1F), -107.8 (d, $J_{\text{FF}} = 255.6$ Hz, 1F), -107.9 (d, $J_{\text{FF}} = 257.5$ Hz, 1F); HRMS: $[\text{M} + \text{Na}]^+$ calcd for $\text{C}_{18}\text{H}_{19}\text{F}_2\text{NO}_5$, 390.1129; found, 390.1133.

(R)-Diethyl 4-[1,1-difluoro-2-oxo-2-(1-phenylethylamino)ethyl]cyclohexa-1,4-diene-1,2-dicarboxylate (3j). Following the general procedure described above, 59.5 mg (63% yield) of **3j** were obtained as a dark brown oil starting from 50 mg of **1b** [29].

Diethyl 4-[1,1-difluoro-2-oxo-2-(propylamino)ethyl]cyclohex-4-ene-1,2-dicarboxylate (3k). Following the general procedure described above, 27 mg of **3k** (40% yield) were obtained as a dark brown oil starting from 30 mg of **1c**. ^1H NMR (CDCl_3 , 300 MHz) δ 0.93 (t, $J = 7.5$ Hz, 3H), 1.23 (t, $J = 6.9$ Hz, 3H), 1.24 (t, $J = 7.2$ Hz, 3H), 1.57 (m, 2H), 2.22–2.37 (m, 2H), 2.50–2.62 (m, 2H), 2.86 (m, 2H), 3.27 (q, $J = 6.0$ Hz, 2H), 4.13 (q, $J = 6.9$ Hz, 4H), 6.18–6.20 (br m, 1H); ^{13}C NMR (300 MHz) δ 11.2, 14.0, 22.4, 25.0 (t, $^4J_{\text{CF}} = 2.3$ Hz), 27.3, 40.4, 40.6, 41.2, 60.8, 60.9, 114.7 (t, $^1J_{\text{CF}} = 250.9$ Hz), 127.6 (t, $^3J_{\text{CF}} = 8.6$ Hz), 129.0 (t, $^2J_{\text{CF}} = 24.1$ Hz), 163.2 (t, $^2J_{\text{CF}} = 30.2$ Hz), 173.7, 173.9; ^{19}F NMR (CDCl_3 , 282 MHz) δ -106.8 (d, $J_{\text{FF}} = 257.8$ Hz, 1F), -107.9 (d, $J_{\text{FF}} = 258.4$ Hz, 1F); HRMS: $[\text{M} + 1]^+$ calcd for $\text{C}_{17}\text{H}_{26}\text{F}_2\text{NO}_5$, 362.1774; found, 362.1779.

Diethyl 4-(1,1-difluoro-2-oxo-2-phenylethyl)cyclohexa-1,4-diene-1,2-dicarboxylate (3l). Following the general procedures described above, 20 mg (48% yield) of **3l** were obtained as a dark brown oil starting from 20 mg of **1d**.

5-(1,1-Difluoro-2-oxo-2-phenylethyl)-2-phenyl-3a,4,7,7a-tetrahydro-1H-isoindole-1,3(2H)-dione (3m). Following the general procedure described above, 15 mg of **3m** (28% yield) were obtained as a dark brown oil starting from 25 mg of **1d**. ^1H NMR (CDCl_3 , 300 MHz) δ 2.26–2.41 (m, 2H), 2.73–2.84 (m, 2H), 3.18–3.30 (m, 2H), 6.33–6.38 (m, 1H), 7.09–7.14 (m, 3H), 7.23–7.35 (m, 5H), 7.47–7.52 (m, 1H), 7.91–7.94 (m, 2H); ^{13}C NMR (CDCl_3 , 300 MHz) δ 23.2 (t, $^3J_{\text{CF}} = 2.6$ Hz), 23.8, 38.8, 39.0, 116.2 (t, $^1J_{\text{CF}} = 253.0$ Hz), 126.4, 128.6, 128.7, 129.1, 129.7 (t, $^3J_{\text{CF}} = 8.9$ Hz), 130.2 (t, $^4J_{\text{CF}} = 3.0$ Hz), 131.8, 133.2 (t, $^2J_{\text{CF}} = 23.9$ Hz), 134.4, 177.7, 178.2, 188.3 (t, $^2J_{\text{CF}} = 32.1$ Hz); ^{19}F NMR (CDCl_3 , 282 MHz) δ -112.367 (d, $J_{\text{FF}} = 284.6$ Hz, 1F), -111.2 (d, $J_{\text{FF}} = 284.4$ Hz, 1F); HRMS: $[\text{M} + 1]^+$ calcd for $\text{C}_{22}\text{H}_{18}\text{F}_2\text{NO}_3$, 382.1255; found, 382.1258.

Diethyl 4-[1,1-difluoro-2-oxo-2-(phenylamino)ethyl]cyclohex-4-ene-1,2-dicarboxylate (3n). Following the general procedure described above, 24.5 mg (58% yield) of **3n** were obtained as a yellow oil starting from 20 mg of **1d**.

Diethyl 4-(2-cyclohexyl-1,1-difluoro-2-oxoethyl)cyclohexa-1,4-diene-1,2-dicarboxylate (3o). Following the general procedure described above, 28 mg of **3o** (54% yield) were obtained as a dark oil starting from 25 mg of **1e**. ^1H NMR (CDCl_3 , 300 MHz) δ 1.11–1.41 (m, 5H), 1.63–1.84 (m, 5H), 2.30–2.46 (m, 5H), 2.71–2.92 (m, 3H), 3.26–3.36 (m, 2H), 6.37–6.41 (m, 1H), 7.25–7.29 (m, 2H), 7.35–7.49 (m, 3H); ^{13}C NMR (300 MHz) δ 30.0 (t, $^4J_{\text{CF}} = 2.7$ Hz), 23.8, 25.3, 25.4, 28.3, 38.7, 45.1, 115.1 (t, $^1J_{\text{CF}} = 253.7$ Hz), 126.4, 128.6, 129.1, 129.5 (t, $^3J_{\text{CF}} = 9.1$ Hz), 132.2 (t, $^2J_{\text{CF}} = 24.2$ Hz), 177.7, 178.2, 202.7 (t, $^2J_{\text{CF}} = 31.7$ Hz); ^{19}F NMR (CDCl_3 , 282 MHz) δ -109.9 (d, $J_{\text{FF}} =$

276.7 Hz, 1F), -106.0 (d, $J_{\text{FF}} = 276.7$ Hz, 1F); HRMS: $[\text{M}]^+$ calcd for $\text{C}_{22}\text{H}_{23}\text{F}_2\text{NO}_3$, 387.1646; found, 387.1656.

Acknowledgements

We would like to thank MICINN (CTQ2010-19774) of Spain and Generalitat Valenciana (PROMETEO/2010/061) for their financial support. P.B. and J.M. express their thanks to the University of Valencia for a predoctoral fellowship.

References

- Vougioukalakis, G. C.; Grubbs, R. H. *Chem. Rev.* **2010**, *110*, 1746. doi:10.1021/cr9002424
- Lozano-Vila, A. M.; Monsaert, S.; Bajek, A.; Verpoort, F. *Chem. Rev.* **2010**, *110*, 4865. doi:10.1021/cr900346r
- Samojłowicz, C.; Bieniek, M.; Grela, K. *Chem. Rev.* **2009**, *109*, 3708. doi:10.1021/cr800524f
- Spandl, R. J.; Rudyk, H.; Spring, D. R. *Chem. Commun.* **2008**, 3001. doi:10.1039/b807278g
- Diver, S. T.; Giessert, A. J. *Chem. Rev.* **2004**, *104*, 1317. doi:10.1021/cr020009e
- Poulsen, C. S.; Madsen, R. *Synthesis* **2003**, 1. doi:10.1055/s-2003-36243
- Li, J.; Lee, D. *Eur. J. Org. Chem.* **2011**, 4269. doi:10.1002/ejoc.201100438
- O'Leary-Steele, C.; Pedersen, P. J.; James, T.; Lanyon-Hogg, T.; Leach, S.; Hayes, J.; Nelson, A. *Chem.–Eur. J.* **2010**, *16*, 9563. doi:10.1002/chem.201000707
- Subrahmanyam, A. V.; Palanichamy, K.; Kaliappan, K. P. *Chem.–Eur. J.* **2010**, *16*, 8545. doi:10.1002/chem.201000482
- Kotha, S.; Meshram, M.; Tiwari, A. *Chem. Soc. Rev.* **2009**, *38*, 2065. doi:10.1039/b810094m
- Rosillo, M.; Domínguez, G.; Casarubios, L.; Amador, U.; Pérez-Castells, J. *J. Org. Chem.* **2004**, *69*, 2084. doi:10.1021/jo0356311
- Villar, H.; Frings, M.; Bolm, C. *Chem. Soc. Rev.* **2007**, *36*, 55. doi:10.1039/b508899m
- Maifeld, S. V.; Lee, D. *Chem.–Eur. J.* **2005**, *11*, 6118. doi:10.1002/chem.200500407
- Stragies, R.; Schuster, M.; Blechert, S. *Angew. Chem., Int. Ed. Engl.* **1997**, *36*, 2518. doi:10.1002/anie.199725181
The first example of CEYM was reported in early 1997.
- Kinoshita, A.; Sakakibara, N.; Mori, M. *J. Am. Chem. Soc.* **1997**, *119*, 12388. doi:10.1021/ja973134u
- Kinoshita, A.; Sakakibara, N.; Mori, M. *Tetrahedron* **1999**, *55*, 8155. doi:10.1016/S0040-4020(99)00297-5
- Grotevendt, A. G. D.; Lummiss, J. A. M.; Mastronardi, M. L.; Fogg, D. E. *J. Am. Chem. Soc.* **2011**, *133*, 15918. doi:10.1021/ja207388v
- Lloyd-Jones, G. C.; Margue, R. G.; de Vries, J. G. *Angew. Chem., Int. Ed.* **2005**, *44*, 7442. doi:10.1002/anie.200502243
- Pacheco, M. C.; Purser, S.; Gouverneur, V. *Chem. Rev.* **2008**, *108*, 1943. doi:10.1021/cr068410e
- Prakesch, M.; Grée, D.; Grée, R. *Acc. Chem. Res.* **2002**, *35*, 175. doi:10.1021/ar010055i
- Xu, B.; Mae, M.; Hong, J. A.; Li, Y.; Hammond, G. B. *Synthesis* **2006**, 803. doi:10.1055/s-2006-926334
- Hammond, G. B. *J. Fluorine Chem.* **2006**, *127*, 476. doi:10.1016/j.jfluchem.2005.12.024
- Fustero, S.; Fernández, B.; Bello, P.; del Pozo, C.; Arimitsu, S.; Hammond, G. B. *Org. Lett.* **2007**, *9*, 4251. doi:10.1021/ol701811z
- Arimitsu, S.; Fernández, B.; del Pozo, C.; Fustero, S.; Hammond, G. B. *J. Org. Chem.* **2008**, *73*, 2656. doi:10.1021/jo7025965
- Fustero, S.; Bello, P.; Fernández, B.; del Pozo, C.; Hammond, G. B. *J. Org. Chem.* **2009**, *74*, 7690. doi:10.1021/jo9013436
- Pujari, S. A.; Kaliappan, K. P.; Valleix, A.; Grée, D.; Grée, R. *Synlett* **2008**, 2503. doi:10.1055/s-2008-1078179
As far as we know, only one example of CEYM involving fluorinated alkynes have been reported.
- Qing, F.-L.; Zheng, F. *Synlett* **2011**, 1052. doi:10.1055/s-0030-1259947
See for a recent review that highlights the importance of gem-difluoro moiety-containing derivatives.
- Fustero, S.; Aceña, J.-F.; Aceña, J. L.; Sánchez-Roselló, M. *Synlett* **2009**, 525. doi:10.1055/s-0028-1087806
- Fustero, S.; Bello, P.; Miró, J.; Simón, A.; del Pozo, C. *Chem.–Eur. J.* **2012**, *18*, 10991. doi:10.1002/chem.201200835

License and Terms

This is an Open Access article under the terms of the Creative Commons Attribution License (<http://creativecommons.org/licenses/by/2.0>), which permits unrestricted use, distribution, and reproduction in any medium, provided the original work is properly cited.

The license is subject to the *Beilstein Journal of Organic Chemistry* terms and conditions: (<http://www.beilstein-journals.org/bjoc>)

The definitive version of this article is the electronic one which can be found at: [doi:10.3762/bjoc.9.305](https://doi.org/10.3762/bjoc.9.305)

Stereoselectively fluorinated *N*-heterocycles: a brief survey

Xiang-Guo Hu and Luke Hunter*

Review

Open Access

Address:
School of Chemistry, The University of New South Wales, Sydney
NSW 2052, Australia

Email:
Luke Hunter* - l.hunter@unsw.edu.au

* Corresponding author

Keywords:
conformation; fluorine; *N*-heterocycles; iminosugars; medicinal
chemistry; organo-fluorine

Beilstein J. Org. Chem. **2013**, *9*, 2696–2708.
doi:10.3762/bjoc.9.306

Received: 16 September 2013
Accepted: 04 November 2013
Published: 29 November 2013

This article is part of the Thematic Series "Organo-fluorine chemistry III".

Guest Editor: D. O'Hagan

© 2013 Hu and Hunter; licensee Beilstein-Institut.
License and terms: see end of document.

Abstract

The stereoselective incorporation of fluorine atoms into *N*-heterocycles can lead to dramatic changes in the molecules' physical and chemical properties. These changes can be rationally exploited for the benefit of diverse fields such as medicinal chemistry and organocatalysis. This brief review will examine some of the effects that fluorine substitution can have in *N*-heterocycles, including changes to the molecules' stability, their conformational behaviour, their hydrogen bonding ability, and their basicity. Finally, some methods for the synthesis of stereoselectively fluorinated *N*-heterocycles will also be reviewed.

Review

1. Introduction

A cursory inspection of the medicinal chemistry literature will reveal two obvious themes in the structures of current drug candidates: the ubiquity of nitrogen heterocycles, and the popularity of organofluorine moieties. Therefore, it seems natural that a combination of these two features will offer rich possibilities in the future of drug development. To date, the introduction of fluorine into medicinal entities [1,2] has mostly taken the form of aryl fluorination [3,4] or trifluoromethylation [5,6], and fascinating developments in synthetic methodology of this type are continuing to occur [7-9]. However, with the advent of stereoselective fluorination methods [10,11] it seems clear that the subset of stereoselectively fluorinated *N*-heterocycles [12]

offers particularly rich possibilities. We therefore felt that it would be worthwhile to examine in a brief review some of the unique features of this emerging class of molecules.

We have not attempted to cover this topic comprehensively; rather, in the following pages we aim to provide selected examples of the ways that fluorine can influence *N*-heterocycles' stability and their conformational behaviour; we will see that fluorine can be used as a tool to probe the importance of hydrogen bonding in bioactive molecules; and we will observe how fluorine can affect the basicity of *N*-heterocycles. Finally, we will survey some of the various ways in which stereoselec-

tively fluorinated *N*-heterocycles can be synthesised. Throughout, it will become clear that medicinal chemistry is not the only field that stands to benefit from a deeper understanding of these fascinating molecules: for example, attractive prospects are also clear in the field of organocatalysis [13].

2. Fluorination can influence *N*-heterocycles' stability and reactivity

If a highly-polarised C–F bond is incorporated into a nitrogen heterocycle, it can be expected to have a dramatic influence on the molecules' physical and chemical properties [14]. The influence that fluorine can have on chemical reactivity is illustrated by considering the smallest *N*-heterocycles, the aziridines. Aziridines (**1**, Figure 1) are generally very stable, in marked contrast with their oxygenated counterparts, the epoxides. However, if one or two fluorine atoms are attached to the aziridine backbone, the resulting molecule is much more susceptible to hydrolysis. De Kimpe and co-workers have investigated the reactivity of mono- and difluoroaziridines **2** and **3** (Figure 1) [15,16]. As well as the enhanced reactivity that **2** and **3** both show towards nucleophilic ring opening, there is an additional subtlety regarding the regioselectivity. While ab initio calculations predict that both **2** and **3** should favour nucleophilic ring opening at C3 [17], preliminary experiments showed that the mono- and difluorinated aziridines actually behave differently in the presence of nucleophiles, with monofluorinated aziridines **2** experiencing C2 attack and the difluorinated counterparts **3** favouring C3 attack.

Fluorination has also been shown to influence reactivity in four-membered *N*-heterocycles (Scheme 1). Kanerva and co-workers

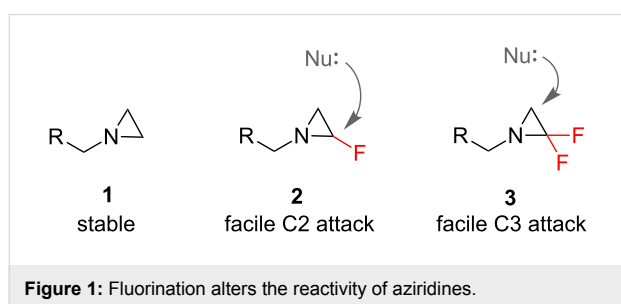

[18] investigated a series of β -lactam derivatives (**4a–c**) in a lipase-catalysed methanolysis process. While the non-fluorinated derivative **4a** was found to be unreactive under the reaction conditions specified, successive introduction of one or two fluorine atoms (**4b** and **4c**) led to a marked increase in reactivity. The enantioselectivity of this approach is also worthy of note, and will be discussed further in a later section of this review.

Now that our survey of *N*-heterocycles has reached ring sizes of four atoms or larger, another important consideration emerges: fluorine can affect the molecules' conformational behaviour [19]. To illustrate this point a series of examples are presented below, drawing from heterocycles with ring sizes of up to eight atoms.

3. Fluorination can influence the conformations of *N*-heterocycles

3.1 Four-membered rings

O'Hagan and co-workers observed an interesting conformational effect in a computational study of fluorinated azetidine derivatives (Figure 2) [20]. The neutral molecule **6** was calculated to prefer a ring pucker which placed the fluorine atom far away from the neutral nitrogen atom (N–C–C–F dihedral angle = 137.2°). However, the story changed markedly with the charged derivative **7**: in this case, the ring pucker inverted and the fluorine atom more closely approached the charged nitrogen atom (N⁺–C–C–F dihedral angle = 100.0°). This contrast was explained by invoking a favourable interaction between the C–F

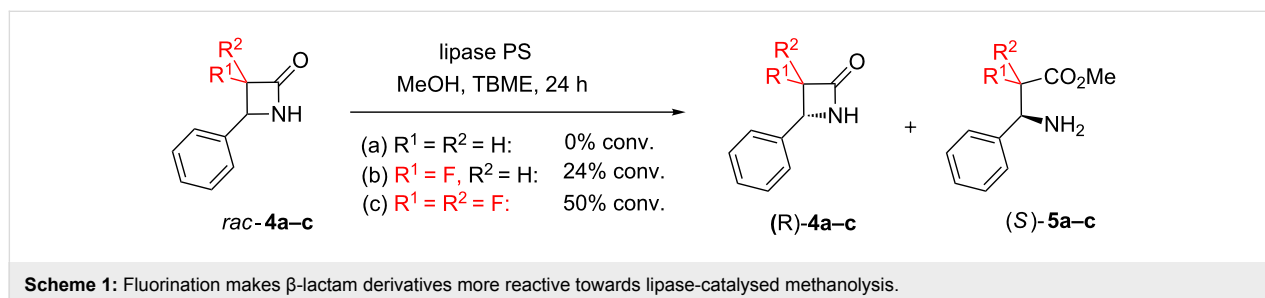
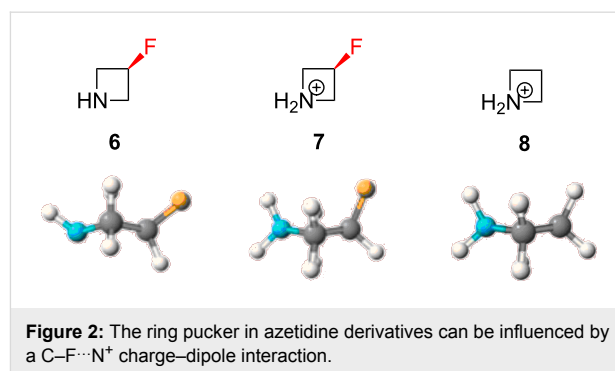

dipole and the charged N^+ atom, and the magnitude of this charge–dipole effect is revealed by comparison with the non-fluorinated control molecule **8** in which the ring pucker is less pronounced ($N-C-C-H$ dihedral angle = 102.3°). It transpires that this $C-F\cdots N^+$ interaction is a general effect which has also been observed in larger N -heterocycles, as discussed below.

3.2 Five-membered rings

The $C-F\cdots N^+$ interaction can have a more dramatic impact on the conformations of pyrrolidines, since they are inherently more flexible than azetidines [21]. For example, O'Hagan and co-workers investigated the pyrrolidine-containing molecules **9** and **10** (Figure 3) as ligands of G-quadruplex DNA [22]. The non-fluorinated ligand **9** had some conformational disorder because the pyrrolidine rings were able to interconvert between *exo* and *endo* puckers. In contrast, the pyrrolidine rings of fluorinated ligand **10** were more rigid, with the fluorine atoms preferring to occupy an axial position consistent with a favourable $C-F\cdots N^+$ interaction (worth approximately 5.0 kcal/mol). This led to a number of changes to the DNA binding mode of **10**, including a rotation of the entire pyrrolidine ring by 180° relative to that of **9**, and several different H-bonding contacts with the DNA as a result.

In contrast with the strong charge–dipole effect evident in pyrrolidine **10** (Figure 3), another more subtle interaction is observed in neutral fluorinated pyrrolidines. For example, Raines and co-workers found that (4*R*)-fluoroproline **12** adopts

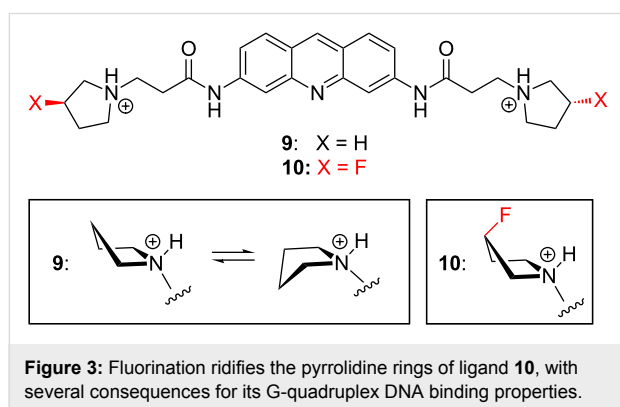

a $C\gamma$ -*exo* ring pucker (Figure 4), in contrast with natural proline **11** which has a more flexible pyrrolidine ring [23]. The increased rigidity of **12** was explained by a stabilising hyperconjugation phenomenon (Figure 4), in which an appropriately-aligned σ_{CH} orbital is able to donate electron density into the vacant σ^*_{CF} antibonding orbital. This stabilising interaction is only possible if the $C-F$ and $C-N$ bonds are aligned *gauche* to one another, and is analogous to the well-known fluorine *gauche* effect [24]. The importance of the rigid $C\gamma$ -*exo* ring pucker of **12** was demonstrated in spectacular fashion: Raines and co-workers showed that the thermal stability of collagen was increased when **12** was incorporated in place of collagen's naturally-present (4*R*)-hydroxyproline residues [25].

This hyperconjugation effect has also been exploited in the context of organocatalysis. Fluorination of proline itself, as well as related N -heterocycles, has been shown to increase enantioselectivity in certain organocatalytic processes [13]. For example, Alexakis and co-workers found that the non-fluorinated catalyst **13** (Scheme 2) catalysed an alkylation reaction (**15**→**17**) with only moderate enantioselectivity [26]. This was ascribed to the flexibility of the pyrrolidine moiety in the enamine intermediate **16**. In contrast, the fluorinated catalyst **14** has a relatively strong (1.5 kcal/mol) preference for an *endo* pucker, stabilised by hyperconjugation, and this increased rigidity was credited with a dramatic improvement in the enantioselectivity.

3.3 Six-membered rings

The conformational analysis of six-membered rings is a cornerstone in physical chemistry. Substituted saturated six-membered compounds usually adopt a chair conformation with substituents preferring the equatorial positions. However, in 1993 Lankin and Snyder [27] observed that fluoropiperidine **18** preferentially adopted a conformation in which the fluorine substituent resides in the axial position (Figure 5). This study was then extended to include piperidines **19** and **20**, and in each case the axial conformers are preferred by a substantial ~ 5.0 kcal/mol over the equatorial conformers (not shown) [28,29]. This pioneering work constituted the original discovery of the $C-F\cdots N^+$ interaction which has already been discussed

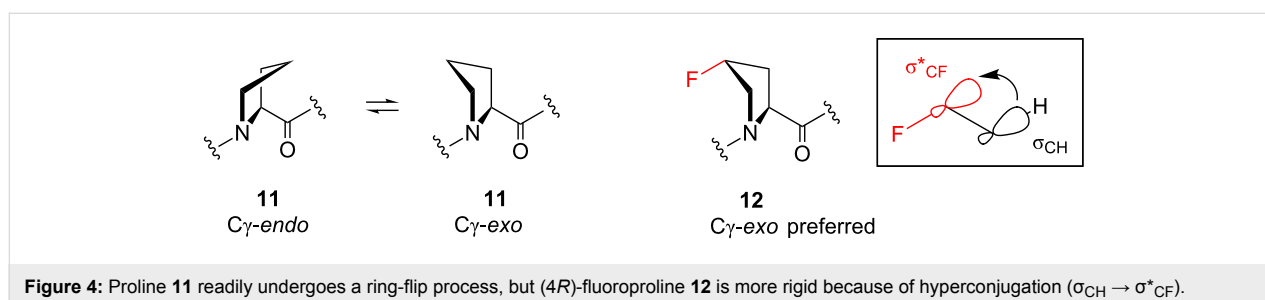

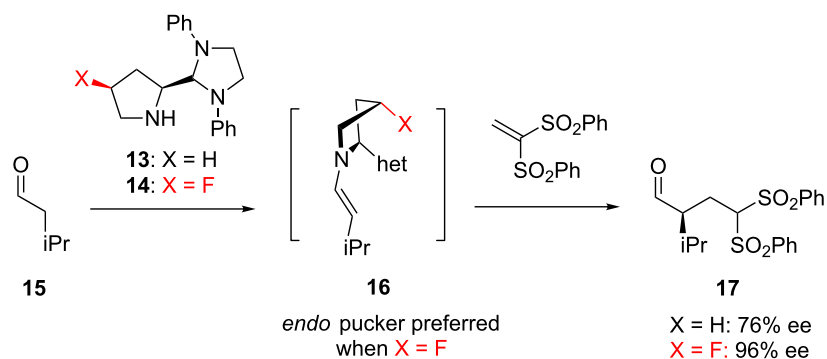

Scheme 2: Hyperconjugation rigidifies the ring pucker of a fluorinated organocatalyst **14**, leading to higher enantioselectivity.

above in the context of azetidines and pyrrolidines. Interestingly, Lankin and Snyder were also able to rule out hydrogen bonding as the source of the axial preference, since the *N,N*-dimethyl analogue **20** exhibited a similar effect.

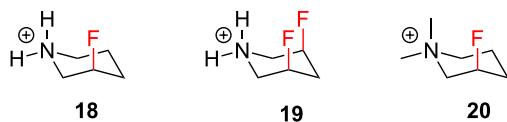

Figure 5: Fluorinated piperidines prefer the axial conformation, due to stabilising C–F \cdots N⁺ interactions.

3.4 Seven-membered rings

Seven-membered rings exhibit much more complex conformational behaviour than six-membered rings. Hence, it is perhaps unsurprising that a twenty year gap separated the pioneering work of Lankin and Snyder (Figure 5) from the first analysis of fluorinated seven-membered *N*-heterocycles. Liu and co-workers [30] have recently explored the conformational behaviour of the substituted azepanes **21–23** (Figure 6), and observed that the rigidifying power of a fluorine substituent is strongly dependent on the other groups present. The non-fluorinated azepane **21** was found to exhibit extensive conformational disorder, and this was attributed to competing preferences for the OBn/N₃ substituents to adopt pseudoequatorial positions and for the azide group to align *gauche* to the ring nitrogen. The situation was not greatly changed upon introduction of a (6*S*)-fluorine atom (compound **22**): in this case, no single conformation of **22** was able to satisfy a C–F \cdots N⁺ *gauche* alignment as well as the two conformational preferences described for **21**. In contrast however, introduction of a (6*R*)-fluorine atom (compound **23**) greatly rigidified the ring system, to the extent that a single conformer of **23** dominated in solution. This work highlights the subtleties that can arise when fluorine atoms are incorporated into highly flexible molecules with pre-existing substituents.

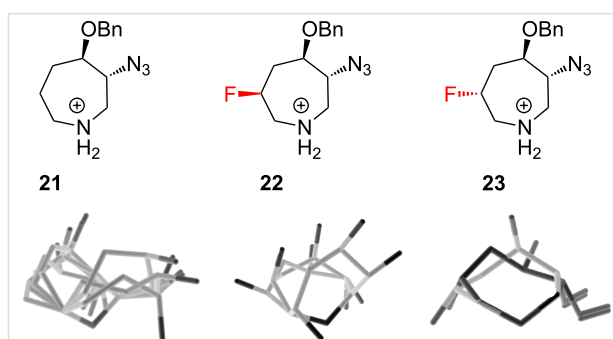

Figure 6: Fluorination can rigidify a substituted azepane, but only if it acts in synergy with the other substituents: azepanes **21** and **22** are disordered, while azepane **23** has one dominant geometry in solution.

3.5 Eight-membered rings

The eight-membered ring is the largest stereoselectively fluorinated *N*-heterocycle that has been investigated to date [20]. O'Hagan and co-workers investigated the structure **24** (Figure 7), and calculated that the axial conformation of **24** should be strongly preferred over the equatorial conformation (9.2 kcal/mol) because of two stabilising C–F \cdots N⁺ interactions. An X-ray structure of **24** was also obtained (Figure 7), and it revealed a geometry consistent with the calculated minimum-energy structure, with no evidence of disorder.

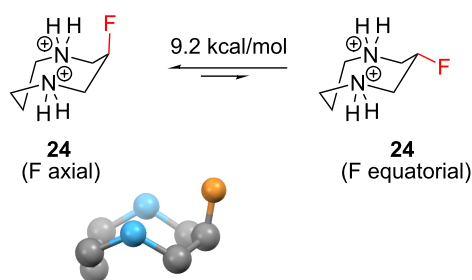

Figure 7: The eight-membered *N*-heterocycle **24** prefers an axial orientation of the fluorine substituent, giving two C–F \cdots N⁺ interactions.

So far in this review, we have primarily been considering fluorine as a replacement for hydrogen in *N*-heterocycles. However a new vista opens up if we consider fluorine as a replacement for the hydroxy group in bioactive molecules.

4. Fluorine can serve as a tool to probe the importance of hydrogen bonding

The replacement of a hydroxy group in a bioactive molecule with a fluorine atom can cause the loss of hydrogen bond donor ability, which may have profound effects on the ligand–receptor interaction. The study of fluorinated iminosugars serves as a good platform to discuss this issue.

Naturally occurring iminosugars, also referred as polyhydroxylated alkaloids or azasugars, are sugar mimics in which a nitrogen atom replaces the ring oxygen of the corresponding monosaccharide (Figure 8) [31–36]. Iminosugars can competitively bind to glycosidase enzymes because of their structural resemblance to the terminal sugar moiety of natural substrates, or to the activated intermediate of hydrolysis (i.e. the oxocarbenium ion). As a consequence, iminosugars show great promise for the treatment of a variety of diseases including diabetes,

viral infection, bacterial infection, and lysosomal storage disorders [37].

Fluorinated analogues of several of these privileged structures have been prepared, in order to probe the importance of hydrogen bonding in these systems [38–43]. For example, 1-deoxynojirimycin (**28**) is the C1-deoxy product of nojirimycin, the first iminosugar isolated from Nature. Iminosugar **28** is a potent inhibitor of yeast α -glycosidase (Figure 9), and the fluorinated analogues **32–34** suggest that the C2 and C4 hydroxy groups of **28** act as H-bond donors when binding to the enzyme, while the C6 hydroxy of **28** does not [44,45].

Miglitol (**30**, Figure 10) is an orally-available drug used for the treatment of type II diabetes. It was first marketed by Merck in 1996. The biological activity of the fluorinated analogues **35–37** (Figure 10) suggest that the C6 hydroxy group of **30** acts as a hydrogen bond donor in its binding to yeast α -glycosidase, while the C2' and C2 hydroxy groups of **30** do not [46,47]. The fluorinated analogue **37** is particularly worthy of note, since this compound is five times more potent than the existing drug **30**, and exhibits no toxicity in human cells.

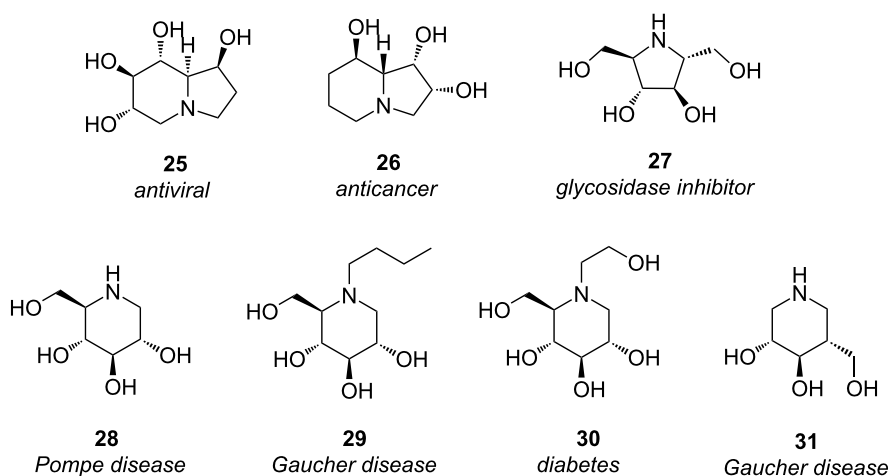

Figure 8: Some iminosugars are “privileged structures” that serve as valuable drug leads.

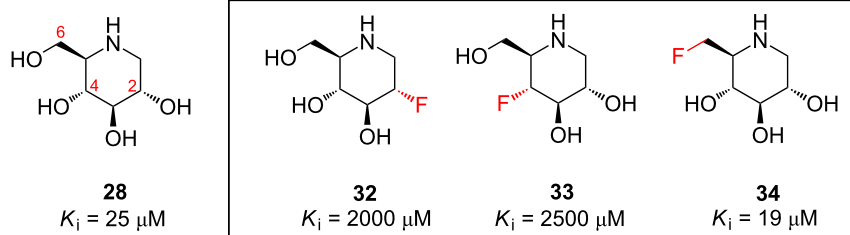

Figure 9: Fluorinated iminosugar analogues **32–34** illuminate the binding interactions of the α -glycosidase inhibitor **28**.

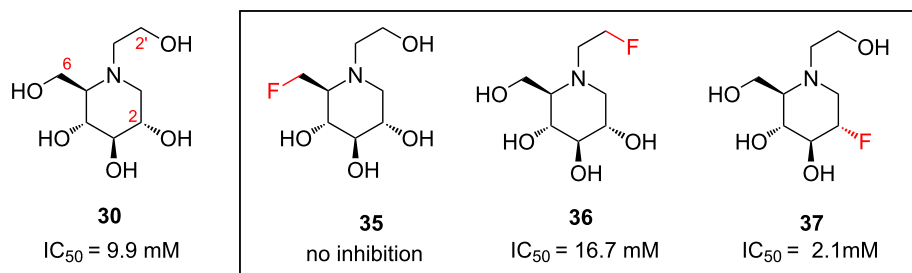

Figure 10: Fluorinated miglitol analogues, and their inhibitory activity towards yeast α -glucosidase.

However, a word of warning: in the fluorinated iminosugar examples discussed above (Figure 9 and Figure 10) the inhibition data must be interpreted with some caution, because another effect could be in operation. As well as changing the molecules' hydrogen bonding properties, fluorination can also affect the basicity of the amine group. This latter effect can be rationally exploited, for example to improve the bioavailability of a drug molecule; this concept is explored in the next section.

5. Fluorination alters the basicity of *N*-heterocycles

The 3-piperidinylindole derivative **38** (Table 1) binds to the human 5-HT_{2A} serotonin receptor, and was identified as a promising antipsychotic drug lead [48]. However, the bioavailability of **38** was poor, and this was attributed to the basicity of the secondary amine group which made the molecule positively charged at physiological pH and hence unable to traverse biological membranes. This problem was overcome by introducing a fluorine atom onto the piperidine ring (**39**): the basicity of the secondary amine was thereby reduced by nearly two orders of magnitude, and this led to a marked improvement in bioavailability. Incidentally, it is also worthy of note that the bioavailability (and 5-HT_{2A} binding affinity) could be further improved by the introduction of a second fluorine atom, this

time onto the indole moiety (**40**); this further improvement in bioavailability was attributed to blockage of the metabolic degradation of **38** and **39** which commenced with hydroxylation of the indole moiety.

In the next example, we return to the world of iminosugars. Isofagomine (**31**, Figure 11) is an inhibitor of the β -glucosidase from sweet almond, and it is thought to exert its inhibitory activity by mimicking the oxocarbenium intermediate of glycoside cleavage [49]. Several analogues of **31** have been investigated (**41–44**, Figure 11) [50–52], and on first inspection it is difficult to rationalise the observed trends in biological activity. One possible explanation for the dramatically improved activity of e.g. **43** over **42** is to invoke the “polar hydrophobic” nature of the fluorine substituent [53,54]. But another important factor is the basicity of the amine group [55]. To best mimic the oxocarbenium ion, the iminosugars **31** and **41–44** (Figure 11) must bear a positive charge, and since the pK_{aH} values vary considerably amongst the different derivatives, it follows that each derivative has a different “optimal” pH for maximal inhibitory potency. This explains why the K_i values in Figure 11 do not seem to follow a clear trend: the quoted K_i values were all measured at the same pH, whereas it would be more revealing to consider the K_i of each molecule at its “optimal” pH. This is

Table 1: Fluorination improves the bioavailability of 3-piperidinylindole derivatives **38–40** by reducing the basicity of the secondary amine.

	38	39	40
pK_{aH}	10.4	8.5	~8.5 ^a
5-HT _{2A} affinity	0.99 nM	0.43 nM	0.06 nM
Bioavailability	“Poor”	18%	80%

^aNot measured, but assumed to be similar to **39**.

a very interesting situation, because it opens up the possibility of developing drugs that are selective for particular pH environments.

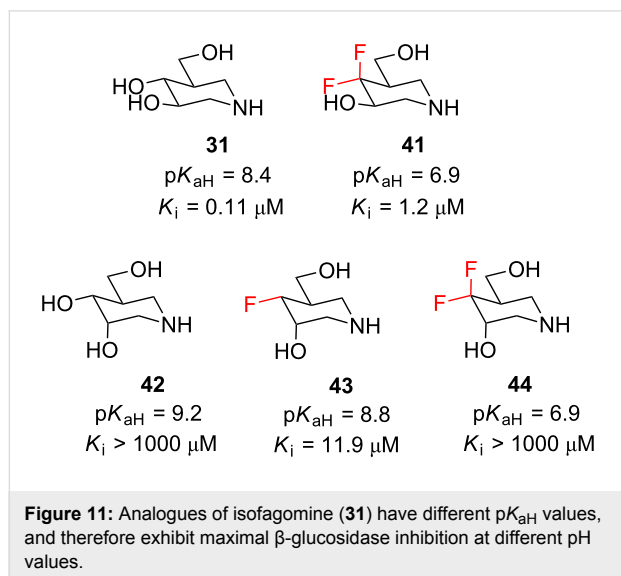

We have now seen that fluorination can affect *N*-heterocycles' stability, their conformational behaviour, their hydrogen bonding ability, and their basicity. It is hopefully clear to the reader that these effects have already led to several benefits in fields such as medicinal chemistry and organocatalysis. If these concepts are to be continued to be exploited in the future, then robust methods must be available for the synthesis of new fluorinated *N*-heterocycles. Hence, in the final section of this review we will examine some of the stereoselective synthetic methods that have been developed in recent years.

6. There are many ways to synthesise stereoselectively fluorinated *N*-heterocycles

6.1 Deoxyfluorination

Because of the ease of synthesis of enantiomerically pure alcohols, and the ever-increasing availability of deoxyfluorination reagents [10], the deoxyfluorination of *N*-protected alcohols is the most obvious strategy for synthesising fluorinated *N*-hetero-

cycles (Scheme 3). Deoxyfluorination methods have already been extensively reviewed [8], and of course they are not limited in scope to *N*-heterocyclic systems, so we will not attempt to comprehensively cover this topic here. Instead, we will focus on two recent developments in deoxyfluorination methods that are particularly relevant to *N*-heterocyclic targets.

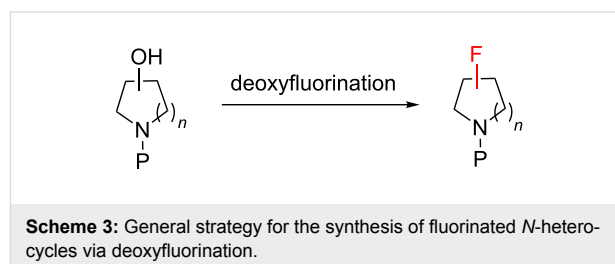

Late stage deoxyfluorination is an attractive method for synthesising multifunctional fluorinated *N*-heterocycles, but mild and selective reagents are required if this is to be successfully achieved. One such reagent, PhenoFluor (**45**, Figure 12), was originally developed by Ritter and co-workers for the direct fluorination of phenols [56]. Recent work showed that **45** can also be used to effect late-stage fluorination of hydroxy groups within complex molecular architectures. For example, **45** can react selectively with primary and allylic alcohols in the presence of secondary and tertiary alcohols, and the reaction will also tolerate the presence of carbonyl groups [57]. Some *N*-heterocyclic targets that have been synthesised in one step using **45** as the deoxyfluorination reagent are highlighted in Figure 12.

A unique complication sometimes arises when deoxyfluorination is attempted in *N*-heterocyclic systems: side reactions can occur, brought about by neighbouring group participation (Scheme 4) [58]. Such processes can lead to rearrangement, and this outcome has been rationally exploited to synthesise fluorinated five- [59], six- [60] and seven-membered [61] *N*-heterocycles that may have been otherwise difficult to access (e.g. **48**→**49**, Scheme 4). Alternatively, neighbouring group participation sometimes results in an unexpected pattern of substitu-

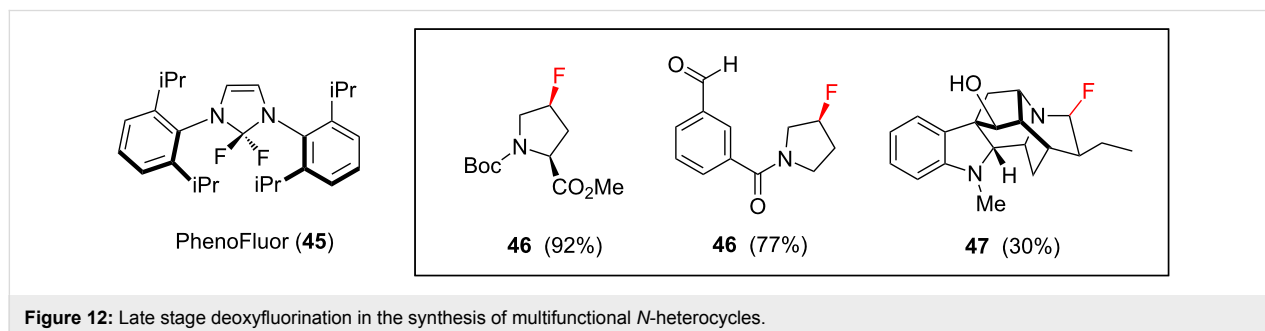

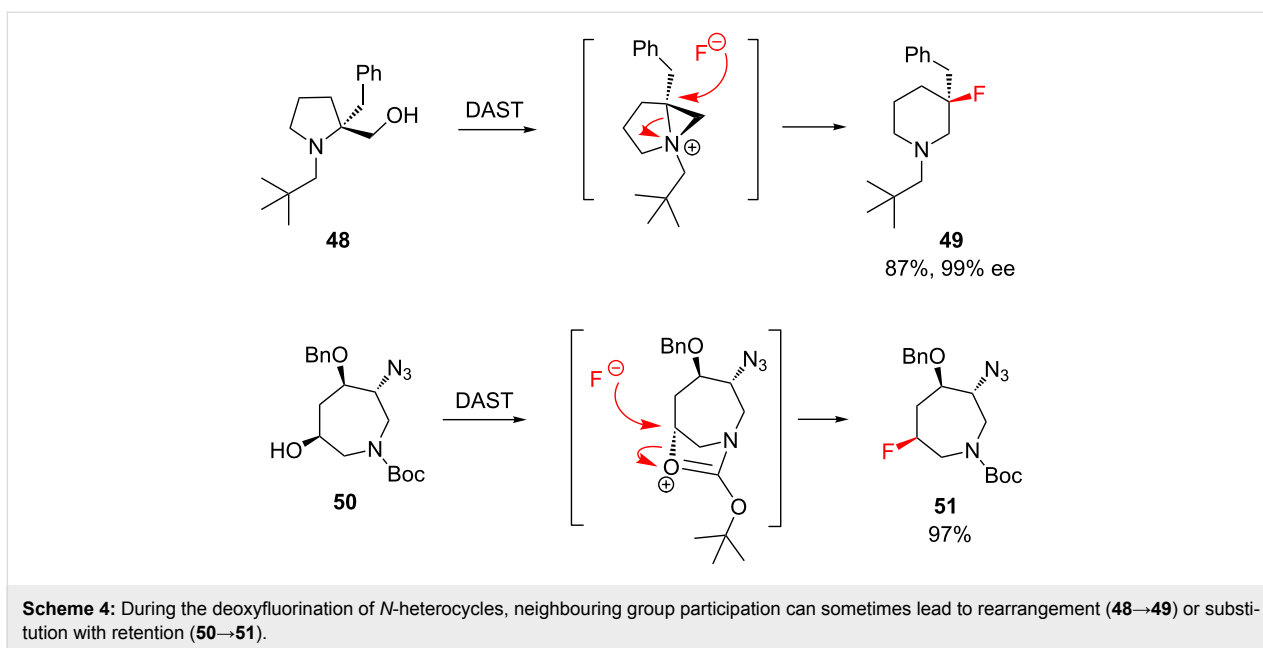

tion with retention (e.g. **50**→**51**, Scheme 4); in the latter example, note that the ring nitrogen does not directly engage in the anchimeric process [62].

6.2 The fluorinated building block approach

An alternative to the strategy of deoxyfluorination (section 6.1) is to synthesise fluorinated *N*-heterocycles starting from fluorine-containing organic building blocks. Such an approach benefits from the wide variety, and frequently the low cost, of today's commercially available organofluorine molecules [63,64].

For example, the fluorinated aziridines **2** and **3** presented earlier (Figure 1) were synthesised through a building block approach. De Kimpe and co-workers [15,16] developed a strategy to synthesise such targets via cyclization of β -fluoro- β -chloroamines (**54**, Scheme 5), which in turn are derived from the readily-available fluoroacetate derivatives **52**.

Percy and co-workers' synthesis of a difluorinated analogue of calystegine B (**63**, Scheme 6) is a more elaborate example of the strategy of using a readily available fluorinated starting material for the synthesis of a complex target [65]. Percy's approach commenced with protected trifluoroethanol **55** (Scheme 6), and the multistep route to **63** featured a [2,3]-Wittig rearrangement, a diastereoselective epoxidation, and a microwave assisted transannular epoxide opening reaction. It is also noteworthy that the starting material **55** contains an extraneous fluorine atom which is deleted during the synthetic sequence; this approach takes advantage of the often low cost and ready availability of perfluorinated building blocks.

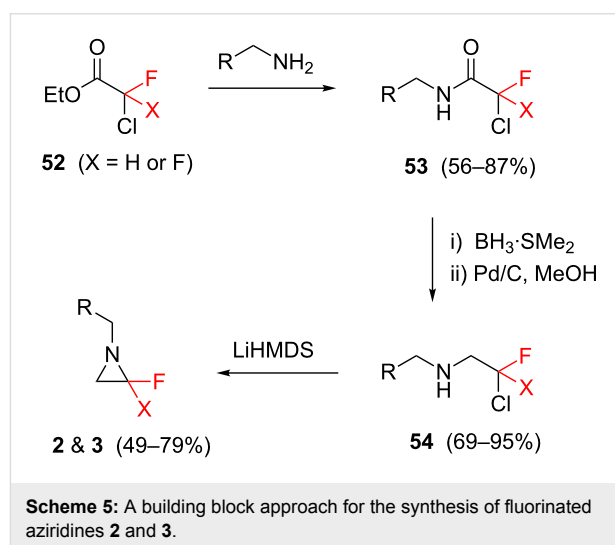

It should be noted, however, that access to enantiopure targets is not straightforward via the building block approach. Such targets may be better obtained through diastereoselective or enantioselective fluorination methods, and examples of these types of approaches are examined in the following sections.

6.3 Diastereoselective fluorocyclisation

The use of fluorocyclisation processes for the production of heterocycles and carbocycles has attracted considerable attention in recent years. Such processes have the advantage of forming multiple bonds in one pot [66]. Electrophilic fluorocyclisation involving the intrinsic nucleophilicity of nitrogen can be a powerful tool to synthesise stereoselectively fluorinated *N*-heterocycles. This concept was exemplified by Shibata

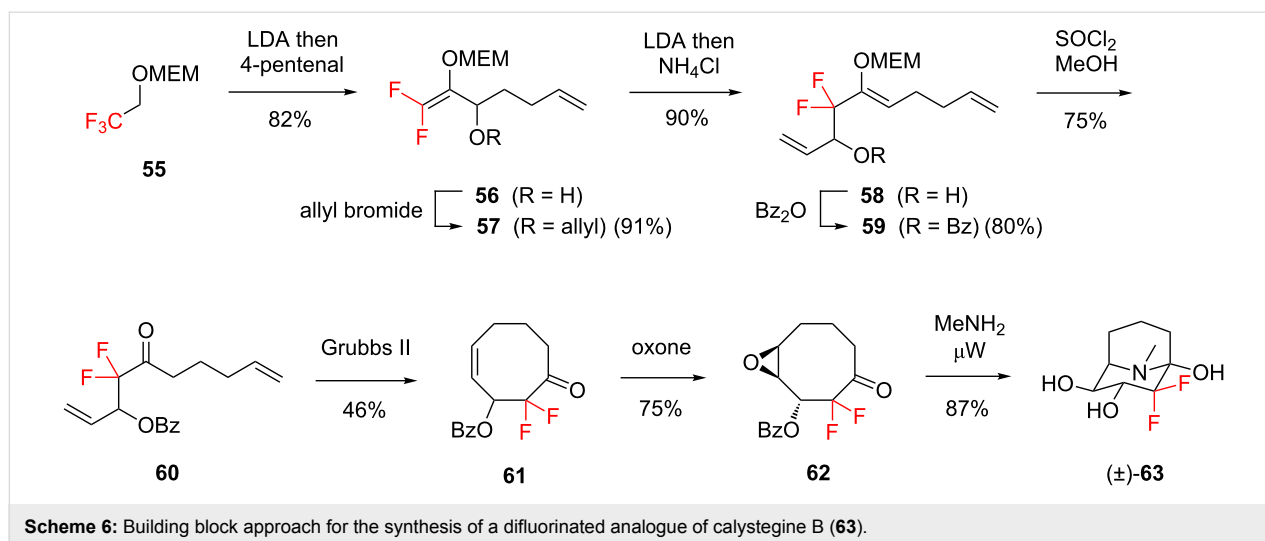

and co-workers [67], who in 2001 reported an elegant and efficient method for synthesising fluorinated analogues of the natural product brevianamide E [68] (**65**, Scheme 7). This synthesis was remarkable for its rapid generation of molecular complexity, which is a defining feature of the fluorocyclisation approach. Even more spectacular was the extension of this methodology to create analogues of the natural product gypsetin [69,70] (**68**) via a double fluorocyclisation sequence (Scheme 7). The one drawback of this approach was its disappointing lack of diastereoselectivity, which presumably arose

because nonselective fluoroquaternisation of the indole moiety preceded the cyclisation event.

6.4 Enantioselective fluorocyclisation

The lack of diastereoselectivity seen in Scheme 7 is attributable to the fluorination event preceding the cyclisation event, and this is a significant issue which inhibits the further development of diastereoselective processes. However, this issue does not preclude the development of enantioselective variants, provided the initial fluorination event can be controlled [11].

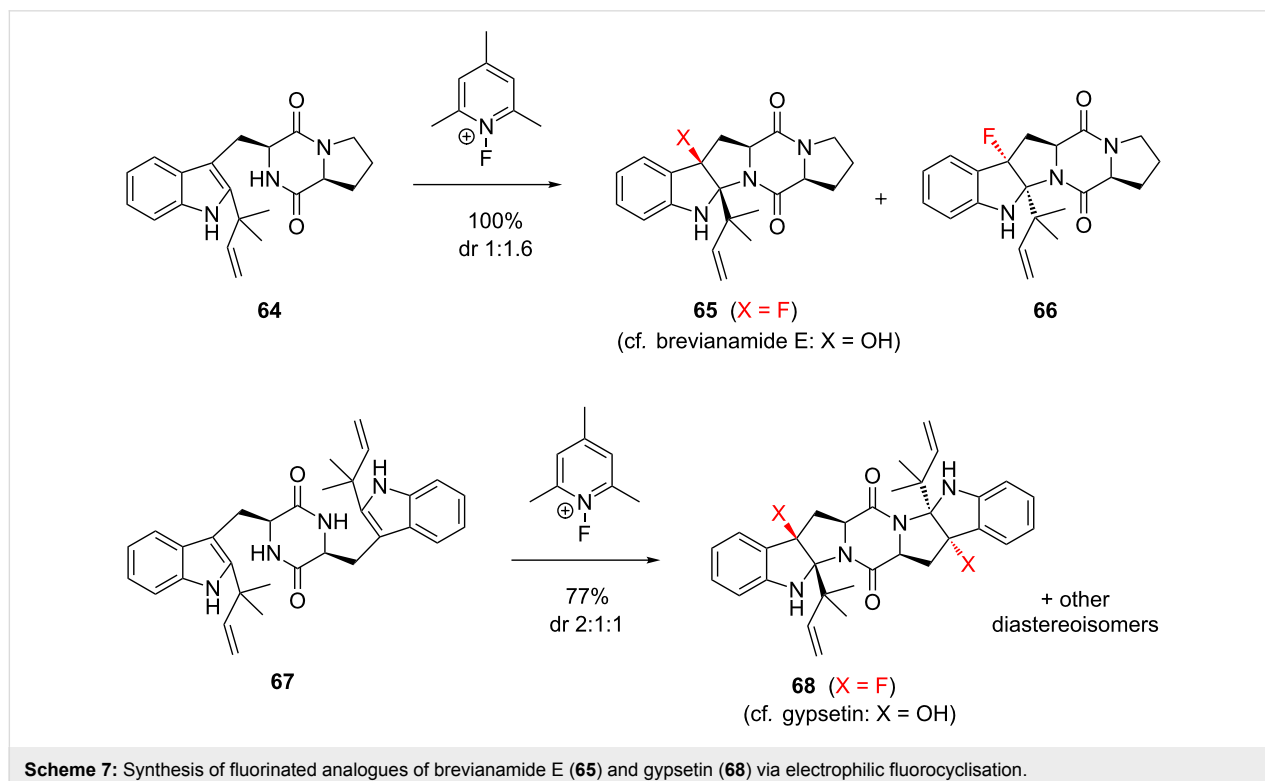

Gouverneur and co-workers recently reported the first enantioselective electrophilic fluorocyclisation (Scheme 8) [71]. Their substrates (e.g. **69**) were indole derivatives bearing a pendant nitrogen nucleophile, and the source of chirality was a substoichiometric quantity of the cinchona alkaloid derivative (DHQ)₂PHAL (**70**). This method was shown to work very well with several different pendant nucleophiles, but the *N*-acetamido nucleophile was found to be optimal, giving the corresponding product **71** in an impressive 92% ee. Elucidating the mechanism of chiral induction in this type of process is not straightforward, but preliminary experiments showed that associative complexation between the substrate **69** and the alkaloid catalyst **70** may account for the observed enantioselectivity.

6.5 Radical reactions

Examples of direct fluorination of C–H bonds with fluorine-containing radicals are rare in the literature, especially if stereoselective versions of such reactions are sought. However, this transformation can be a very effective and concise method for synthesising fluorinated *N*-heterocycles. For example, *L*-*cis*-3-fluoroazetidine-2-carboxylic acid (**73**) was synthesised in one step from the corresponding amino acid **72** by photofluorination with fluoroxytrifluoromethane as the source of the fluorine radical, in 53% yield [72] (Scheme 9).

Radical reactions can also be used to generate *gem*-difluorinated *N*-heterocycles. For example, Hu and Li [73] employed the versatile reagent **74** (Scheme 10) in their synthesis of the chiral 3,3-difluoropyrrolidine derivative **78**. Reagent **74** can act as either a CF₂ anion equivalent or a CF₂ radical equivalent (Scheme 10, inset), and in Hu's synthesis this reagent fulfils both functions at different stages: thus, the target **78** is achieved

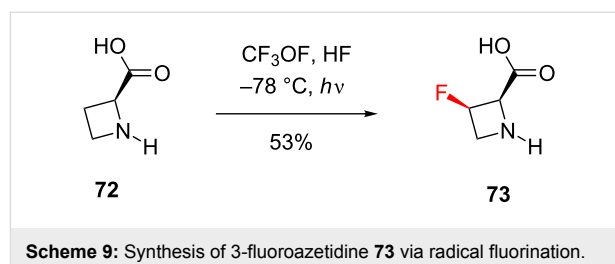

from *N*-(*tert*-butylsulfinyl)imine **75** through a nucleophilic addition/radical cyclisation sequence. The selectivity during the radical cyclisation (**77**→**78**) can be explained by the Beckwith–Houk transition-state model [74,75]. The 3,3-difluoropyrrolidine moiety (e.g. **78**) is found in a variety of enzyme inhibitors such as thrombin inhibitors and cathepsin inhibitors, and so this synthetic methodology (Scheme 10) is likely to have valuable future applications in medicinal chemistry.

6.6 Chemoenzymatic synthesis

Enzyme catalysis was presented earlier (Scheme 1) as a strategy for synthesising fluorinated β-lactams (**4**) [18]. At that time, we were interested in the effect that the fluorine substituents had on the reactivity of the β-lactam derivatives. However this work now merits further attention, because it also illustrates a strategy for achieving stereoselectivity in C–F bond formation. The racemic β-lactam **4b** was synthesised as a single diastereoisomer from the Schiff base **79** (Scheme 11), by a Reformatsky addition followed by spontaneous cyclisation; removal of the amine protecting group under oxidative conditions then furnished *rac*-**4b**, the substrate for enzymatic resolution. Using an immobilized lipase enzyme as the catalyst (and under slightly different conditions from those described in Scheme 1),

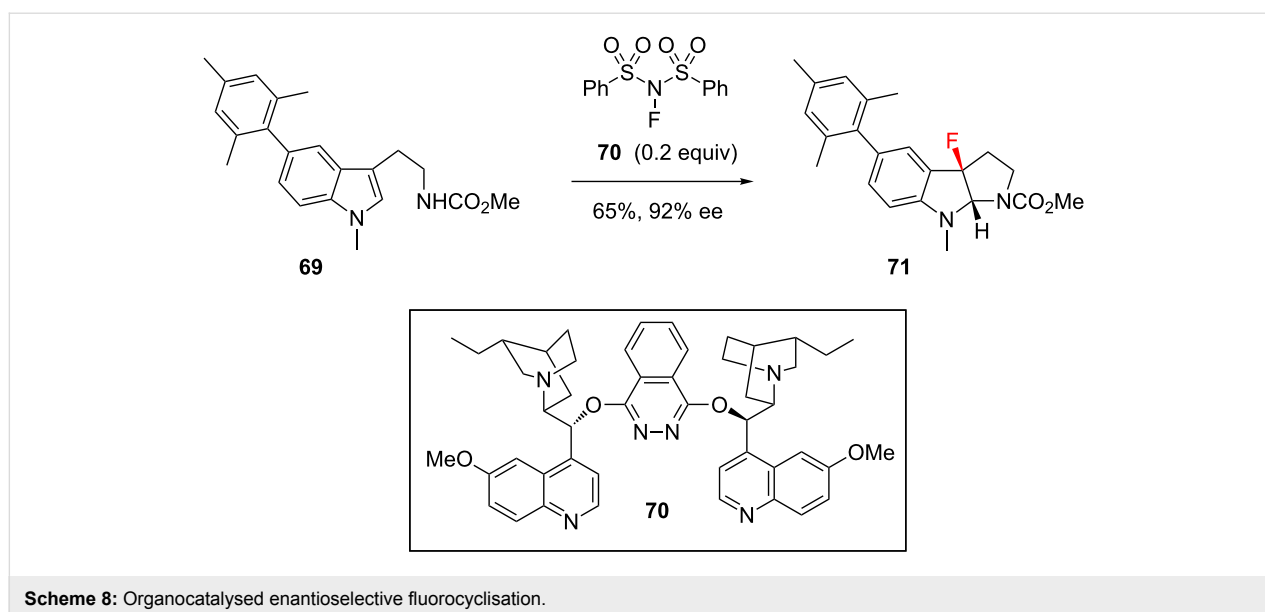

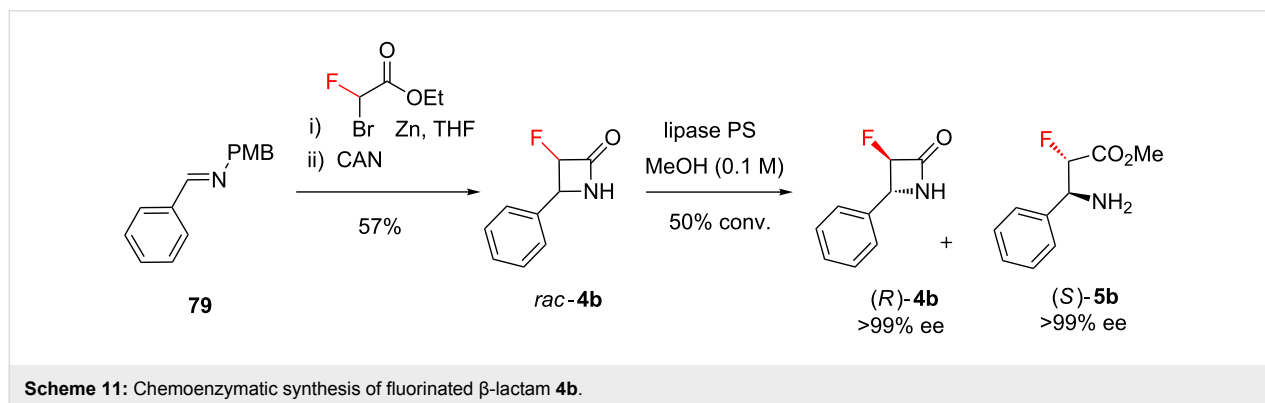
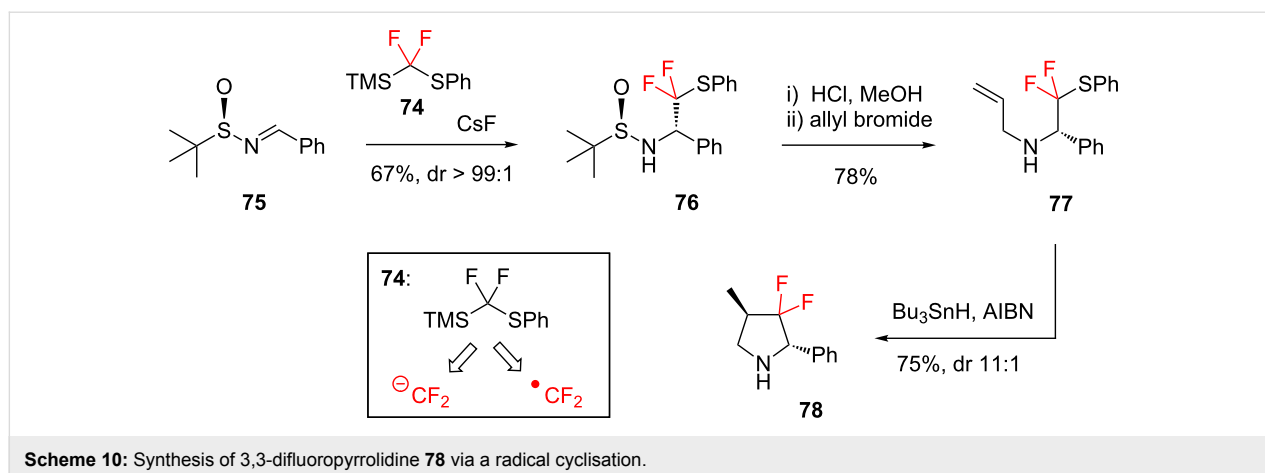

one enantiomer of the racemic β -lactam **4b** was completely transformed into the ester **5b**, while the other enantiomer of β -lactam **4b** remained intact. The net result was that a fluorinated stereocentre was rapidly constructed, with defined absolute configuration, within a nitrogen heterocycle.

Conclusion

When the concept of selective fluorination is applied in the context of *N*-heterocycles, the resulting molecules have a variety of unique properties. In this brief review, we have examined some of these features, including the effects on stability, conformation, hydrogen bonding ability and basicity, and we have also surveyed some of the synthetic methods that are currently available for the production of such molecules. Throughout, we have seen that the unique properties of stereoselectively fluorinated *N*-heterocycles have led to a variety of valuable applications of these molecules, particularly in the field of medicinal chemistry.

What does the future hold? It is interesting to note that the molecules described in this review all comprise ring sizes of three to eight atoms; in contrast, macrocyclic structures have been little explored to date. It will be fascinating to learn

whether similar effects operate in much larger ring sizes, for example in fluorinated analogues of cyclic peptides [76–78]. More generally however, it seems safe to predict that the unique properties of stereoselectively fluorinated *N*-heterocycles will ensure that their importance and utility continue to grow in the future.

Acknowledgement

We thank the Australian Research Council (DE120101653) for supporting XGH's position.

References

- Ismail, F. M. D. *J. Fluorine Chem.* **2002**, *118*, 27–33. doi:10.1016/S0022-1139(02)00201-4
- O'Hagan, D. *J. Fluorine Chem.* **2010**, *131*, 1071–1081. doi:10.1016/j.jfluchem.2010.03.003
- Grushin, V. V. *Acc. Chem. Res.* **2010**, *43*, 160–171. doi:10.1021/ar9001763
- Furuya, T.; Kamlet, A. S.; Ritter, T. *Nature* **2011**, *473*, 470–477. doi:10.1038/nature10108
- Shimizu, M.; Hiyama, T. *Angew. Chem., Int. Ed.* **2004**, *44*, 214–231. doi:10.1002/anie.200460441
- Tomashenko, O. A.; Grushin, V. V. *Chem. Rev.* **2011**, *111*, 4475–4521. doi:10.1021/cr1004293

7. Fujiwara, Y.; Dixon, J. A.; O'Hara, F.; Daa Funder, E.; Dixon, D. D.; Rodriguez, R. A.; Baxter, R. D.; Herlé, B.; Sach, N.; Collins, M. R.; Ishihara, Y.; Baran, P. S. *Nature* **2012**, *492*, 95–99. doi:10.1038/nature11680
8. Liang, T.; Neumann, C. N.; Ritter, T. *Angew. Chem., Int. Ed.* **2013**, *52*, 8214–8264. doi:10.1002/anie.201206566
9. Sandford, G. *Top. Heterocycl. Chem.* **2012**, *27*, 1–32. doi:10.1007/7081_2011_63
10. Al-Maharik, N.; O'Hagan, D. *Aldrichimica Acta* **2011**, *44*, 65–75.
11. Ma, J.-A.; Cahard, D. *Chem. Rev.* **2004**, *104*, 6119–6146. doi:10.1021/cr030143e
12. Petrov, C. A., Ed. *Fluorinated Heterocyclic Compounds: Synthesis, Chemistry and Applications*; John Wiley & Sons: Hoboken, NJ, USA, 2009.
13. Zimmer, L. E.; Sparr, C.; Gilmour, R. *Angew. Chem., Int. Ed.* **2011**, *50*, 11860–11871. doi:10.1002/anie.201102027
14. O'Hagan, D. *Chem. Soc. Rev.* **2008**, *37*, 308–319. doi:10.1039/b711844a
15. van Hende, E.; Verniest, G.; Surmont, R.; De Kimpe, N. *Org. Lett.* **2007**, *9*, 2935–2937. doi:10.1021/ol071127x
16. Verniest, G.; Colpaert, F.; Van Hende, E.; De Kimpe, N. *J. Org. Chem.* **2007**, *72*, 8569–8572. doi:10.1021/jo071253e
17. Banks, H. D. *J. Org. Chem.* **2006**, *71*, 8089–8097. doi:10.1021/jo061255j
18. Li, X.-G.; Lähtie, M.; Päiviö, M.; Kanerva, L. T. *Tetrahedron: Asymmetry* **2007**, *18*, 1567–1573. doi:10.1016/j.tetasy.2007.06.033
19. Hunter, L. *Beilstein J. Org. Chem.* **2010**, *6*, No. 38. doi:10.3762/bjoc.6.38
20. Gooseman, N. E. J.; O'Hagan, D.; Slawin, A. M. Z.; Teale, A. M.; Tozer, D. J.; Young, R. J. *Chem. Commun.* **2006**, 3190–3192. doi:10.1039/b606334a
21. Gerig, J. T.; McLeod, R. S. *J. Am. Chem. Soc.* **1973**, *95*, 5725–5729. doi:10.1021/ja00798a046
22. Campbell, N. H.; Smith, D. L.; Reszka, A. P.; Neidle, S.; O'Hagan, D. *Org. Biomol. Chem.* **2011**, *9*, 1328–1331. doi:10.1039/c0ob00886a
23. Holmgren, S. K.; Bretscher, L. E.; Taylor, K. M.; Raines, R. T. *Chem. Biol.* **1999**, *6*, 63–70. doi:10.1016/S1074-5521(99)80003-9
24. Kirsch, P. *Modern Fluoroorganic Chemistry: Synthesis, Reactivity, Applications*; Wiley-VCH: Weinheim, Germany, 2004. doi:10.1002/352760393X
25. Holmgren, S. K.; Taylor, K. M.; Bretscher, L. E.; Raines, R. T. *Nature* **1998**, *392*, 666–667. doi:10.1038/33573
26. Quintard, A.; Langlois, J.-B.; Emery, D.; Mareda, J.; Guénée, L.; Alexakis, A. *Chem.–Eur. J.* **2011**, *17*, 13433–13437. doi:10.1002/chem.201102757
27. Lankin, D. C.; Chandrakumar, N. S.; Rao, S. N.; Spangler, D. P.; Snyder, J. P. *J. Am. Chem. Soc.* **1993**, *115*, 3356–3357. doi:10.1021/ja00061a055
28. Snyder, J. P.; Chandrakumar, N. S.; Sato, H.; Lankin, D. C. *J. Am. Chem. Soc.* **2000**, *122*, 544–545. doi:10.1021/ja9934504
29. Sum, A. M.; Lankin, D. C.; Hardcastle, K.; Snyder, J. P. *Chem.–Eur. J.* **2005**, *11*, 1579–1591. doi:10.1002/chem.200400835
30. Patel, A. R.; Ball, G.; Hunter, L.; Liu, F. *Org. Biomol. Chem.* **2013**, *11*, 3781–3785. doi:10.1039/c3ob40391b
31. Compain, P.; Martin, O. R., Eds. *Iminosugars: From Synthesis to Therapeutic Applications*; Wiley-VCH: Chichester, UK, 2007.
32. Stütz, A. E., Ed. *Iminosugars as Glycosidase Inhibitors: Nojirimycin and Beyond*; Wiley-VCH: Weinheim, Germany, 1999.
33. Asano, N.; Nash, R. J.; Molyneux, R. J.; Fleet, G. W. J. *Tetrahedron: Asymmetry* **2000**, *11*, 1645–1680. doi:10.1016/S0957-4166(00)00113-0
34. Watson, A. A.; Fleet, G. W. J.; Asano, N.; Molyneux, R. J.; Nash, R. J. *Phytochemistry* **2001**, *56*, 265–295. doi:10.1016/S0031-9422(00)00451-9
35. Lillelund, V. H.; Jensen, H. H.; Liang, X.; Bols, M. *Chem. Rev.* **2002**, *102*, 515–554. doi:10.1021/cr000433k
36. Whalen, L. J.; Wong, C.-H. *Aldrichimica Acta* **2006**, *39*, 63–71.
37. Nash, R. J.; Kato, A.; Yu, C.-Y.; Fleet, G. W. J. *Future Med. Chem.* **2011**, *3*, 1513–1521. doi:10.4155/fmc.11.117
38. Thaharn, W.; Bootwicha, T.; Soorukram, D.; Kuhakarn, C.; Prabpai, S.; Kongsaree, P.; Tuchinda, P.; Reutrakul, V.; Pohmakotr, M. *J. Org. Chem.* **2012**, *77*, 8465–8479. doi:10.1021/jo301327s
39. Reymond, J.-L.; Pinkerton, A. A.; Vogel, P. *J. Org. Chem.* **1991**, *56*, 2128–2135. doi:10.1021/jo00006a031
40. Fumeaux, R. H.; Mason, J. M.; Tyler, P. C. *Tetrahedron Lett.* **1994**, *35*, 3143–3146. doi:10.1016/S0040-4039(00)76852-3
41. Fumeaux, R. H.; Gainsford, G. J.; Mason, J. M.; Tyler, P. C. *Tetrahedron* **1994**, *50*, 2131–2160. doi:10.1016/S0040-4020(01)85075-4
42. Fumeaux, R. H.; Gainsford, G. J.; Mason, J. M.; Tyler, P. C.; Hartley, O.; Winchester, B. G. *Tetrahedron* **1995**, *51*, 12611–12630. doi:10.1016/0040-4020(95)00803-G
43. Li, Y.-X.; Huang, M.-H.; Yamashita, Y.; Kato, A.; Jia, Y.-M.; Wang, W.-B.; Fleet, G. W. J.; Nash, R. J.; Yu, C.-Y. *Org. Biomol. Chem.* **2011**, *9*, 3405–3414. doi:10.1039/c0ob01063d
44. Kajimoto, T.; Liu, K. K. C.; Derson, R. L.; Zhong, Z. Y.; Ichikawa, Y.; Porco, J. A.; Wong, C. H. *J. Am. Chem. Soc.* **1991**, *113*, 6187–6196. doi:10.1021/ja00016a039
45. Anderson, S. M.; Ebner, M.; Ekhardt, C. W.; Gradnig, G.; Legler, G.; Lundt, I.; Stütz, A. E.; Withers, S. G.; Wrodnigg, T. *Carbohydr. Res.* **1997**, *301*, 155–166. doi:10.1016/S0008-6215(97)00099-2
46. Prell, E.; Csuk, R. *Bioorg. Med. Chem. Lett.* **2009**, *19*, 5673–5674. doi:10.1016/j.bmcl.2009.08.012
47. Prell, E.; Korb, C.; Kluge, R.; Ströhl, D.; Csuk, R. *Arch. Pharm.* **2010**, *343*, 583–589. doi:10.1002/ardp.200900256
48. Rowley, M.; Hallett, D. J.; Goodacre, S.; Moyes, C.; Crawforth, J.; Sparey, T. J.; Patel, S.; Marwood, R.; Patel, S.; Thomas, S.; Hitzel, L.; O'Connor, D.; Szeto, N.; Castro, J. L.; Hutson, P. H.; Macleod, A. M. *J. Med. Chem.* **2001**, *44*, 1603–1614. doi:10.1021/jm0004998
49. Jespersen, T. M.; Dong, W.; Sierks, M. R.; Skrydstrup, T.; Lundt, I.; Bols, M. *Angew. Chem., Int. Ed. Engl.* **1994**, *33*, 1778–1779. doi:10.1002/anie.199417781
50. Li, R.-J.; Bols, M.; Rousseau, C.; Zhang, X.-G.; Wang, R.-W.; Qing, F.-L. *Tetrahedron* **2009**, *65*, 3717–3727. doi:10.1016/j.tet.2009.02.079
51. Yang, Y.; Zheng, F.; Bols, M.; Marinescu, L. G.; Qing, F.-L. *J. Fluorine Chem.* **2011**, 838–845. doi:10.1016/j.jfluchem.2011.05.031
52. López, O.; Qing, F.-L.; Pedersen, C. M.; Bols, M. *Bioorg. Med. Chem.* **2013**, *21*, 4755–4761. doi:10.1016/j.bmc.2013.03.003
53. Biffinger, J. C.; Kim, H. W.; DiMagno, S. G. *ChemBioChem* **2004**, *5*, 622–627. doi:10.1002/cbic.200300910
54. Ioannou, A.; Cini, E.; Timofte, R. S.; Flitsch, S. L.; Turner, N. J.; Linclau, B. *Chem. Commun.* **2011**, *47*, 11228–11230. doi:10.1039/c1cc13956h
55. Jensen, H. H.; Lyngbye, L.; Jensen, A.; Bols, M. *Chem.–Eur. J.* **2002**, *8*, 1218–1226. doi:10.1002/1521-3765(20020301)8:5<1218::AID-CHEM1218>3.0.CO;2-X

56. Tang, P.; Wang, W.; Ritter, T. *J. Am. Chem. Soc.* **2011**, *133*, 11482–11484. doi:10.1021/ja2048072
57. Sladojevich, F.; Arlow, S. I.; Tang, P.; Ritter, T. *J. Am. Chem. Soc.* **2013**, *135*, 2470–2473. doi:10.1021/ja3125405
58. Ferret, H.; Déchamps, I.; Gomez Pardo, D.; Van Hijfte, L.; Cossy, J. *ARKIVOC* **2010**, No. 8, 126–159. doi:10.3998/ark.5550190.0011.812
59. Drouillat, B.; Couty, F.; David, O.; Evano, G.; Marrot, J. *Synlett* **2008**, 1345–1348. doi:10.1055/s-2008-1072770
60. Déchamps, I.; Gomez Pardo, D.; Cossy, J. *Synlett* **2007**, 263–267. doi:10.1055/s-2007-967989
61. Déchamps, I.; Gomez Pardo, D.; Cossy, J. *Eur. J. Org. Chem.* **2007**, 4224–4234. doi:10.1002/ejoc.200700237
62. Patel, A. R.; Liu, F. *Tetrahedron* **2012**, *69*, 744–752. doi:10.1016/j.tet.2012.10.078
63. Zhu, S. Z.; Wang, Y. L.; Peng, W. M. *Curr. Org. Chem.* **2002**, *6*, 1057–1096. doi:10.2174/1385272023373635
64. Percy, J. M. Building Block Approaches to Aliphatic Organofluorine Compounds. In *Organofluorine Chemistry: Techniques and Synthons*; Chambers, R. D., Ed.; Springer-Verlag: Berlin, Germany, 1997; pp 131–195.
65. Kyne, S. H.; Miles, J. A. L.; Percy, J. M.; Singh, K. *J. Org. Chem.* **2012**, *77*, 991–998. doi:10.1021/jo2022845
66. Wilkinson, S. C.; Salmon, R.; Gouverneur, V. *Future Med. Chem.* **2009**, *1*, 847–863. doi:10.4155/fmc.09.47
67. Shibata, N.; Tarui, T.; Doi, Y.; Kirk, K. L. *Angew. Chem., Int. Ed.* **2001**, *40*, 4461–4463. doi:10.1002/1521-3773(20011203)40:23<4461::AID-ANIE4461>3.0.CO;2-E
68. Birch, A. J.; Wright, J. J. *J. Chem. Soc. D* **1969**, 644b–645. doi:10.1039/C2969000644B
69. Shinohara, C.; Hasumi, K.; Takei, Y.; Endo, A. *J. Antibiot.* **1994**, *47*, 163–167. doi:10.7164/antibiotics.47.163
70. Nuber, B.; Hansske, F.; Shinohara, C.; Miura, S.; Hasumi, K.; Endo, A. *J. Antibiot.* **1994**, *47*, 168–172. doi:10.7164/antibiotics.47.168
71. Lozano, O.; Blessley, G.; del Campo, T. M.; Thompson, A. L.; Giuffredi, G. T.; Bettati, M.; Walker, M.; Borman, R.; Gouverneur, V. *Angew. Chem., Int. Ed.* **2011**, *50*, 8105–8109. doi:10.1002/anie.201103151
72. Kollonitsch, J.; Barash, L.; Doldouras, G. A. *J. Am. Chem. Soc.* **1970**, *92*, 7494–7495. doi:10.1021/ja00728a056
73. Li, Y.; Hu, J. *Angew. Chem., Int. Ed.* **2007**, *46*, 2489–2492. doi:10.1002/anie.200604783
74. Beckwith, A. L. J. *Tetrahedron* **1981**, *37*, 3073–3100. doi:10.1016/S0040-4020(01)98839-8
75. Spellmeyer, D. C.; Houk, K. N. *J. Org. Chem.* **1987**, *52*, 959–974. doi:10.1021/jo00382a001
76. Hunter, L.; Chung, J. H. *J. Org. Chem.* **2011**, *76*, 5502–5505. doi:10.1021/jo200813a
77. Hunter, L.; Jolliffe, K. A. J.; Jordan, M. J. T.; Jensen, P.; Macquart, R. B. *Chem.–Eur. J.* **2011**, *17*, 2340–2343. doi:10.1002/chem.201003320
78. Hunter, L. *Chim. Oggi* **2012**, *30* (3), 20–22.

License and Terms

This is an Open Access article under the terms of the Creative Commons Attribution License (<http://creativecommons.org/licenses/by/2.0>), which permits unrestricted use, distribution, and reproduction in any medium, provided the original work is properly cited.

The license is subject to the *Beilstein Journal of Organic Chemistry* terms and conditions: (<http://www.beilstein-journals.org/bjoc>)

The definitive version of this article is the electronic one which can be found at: [doi:10.3762/bjoc.9.306](https://doi.org/10.3762/bjoc.9.306)

Flow microreactor synthesis in organo-fluorine chemistry

Hideki Amii^{*1}, Aiichiro Nagaki² and Jun-ichi Yoshida^{*2}

Review

Open Access

Address:

¹Division of Molecular Science, Graduate School of Science and Technology, Gunma University, Tenjin-cho, Kiryu, Gunma 376-8515, Japan and ²Department of Synthetic and Biological Chemistry, Graduate School of Engineering, Kyoto University, Nishikyo-ku, Kyoto 615-8510, Japan

Email:

Hideki Amii^{*} - amii@gunma-u.ac.jp; Jun-ichi Yoshida^{*} - yoshida@sbchem.kyoto-u.ac.jp

^{*} Corresponding author

Keywords:

defluorination; fluorine; fluorination; flow microreactor; organo-fluorine; perfluoroalkylation

Beilstein J. Org. Chem. **2013**, *9*, 2793–2802.

doi:10.3762/bjoc.9.314

Received: 11 September 2013

Accepted: 05 November 2013

Published: 05 December 2013

This article is part of the Thematic Series "Organo-fluorine chemistry III".

Guest Editor: D. O'Hagan

© 2013 Amii et al; licensee Beilstein-Institut.

License and terms: see end of document.

Abstract

Organo-fluorine compounds are the substances of considerable interest in various industrial fields due to their unique physical and chemical properties. Despite increased demand in wide fields of science, synthesis of fluoro-organic compounds is still often faced with problems such as the difficulties in handling of fluorinating reagents and in controlling of chemical reactions. Recently, flow microreactor synthesis has emerged as a new methodology for producing chemical substances with high efficiency. This review outlines the successful examples of synthesis and reactions of fluorine-containing molecules by the use of flow microreactor systems to overcome long-standing problems in fluorine chemistry.

Review

Fluorine is a key element in the development of materials and biologically active agents. The introduction of fluorine atoms into organic molecules often exerts influences upon physical, chemical, and biological properties [1-8]. Although the fluorine atom is larger than the hydrogen atom, the replacement of hydrogen by fluorine leads to the smallest steric perturbation available to us. In pharmaceuticals, fluorine is often introduced to increase lipophilicity, bioavailability, and metabolic stability; these unique properties are otherwise difficult to obtain. At

present, nearly 15% of medicines and 20% of agrochemicals on the market contain fluorine atoms [6,9,10].

Despite increased demands in wide fields of science, synthesis of fluoro-organic compounds is still often faced with problems such as the difficulty in handling of fluorinating reagents and in controlling of chemical reactions. Furthermore, low stability of fluorine-containing intermediates and low selectivity (chemo-, regio-, and/or stereo-) of the reactions have disturbed the

progress of synthesis of fluorochemicals. New methodologies that can cure the weak points in synthesizing fluoro-organic compounds would open up a new perspective for fluorine chemistry.

Meanwhile, flow microreactor synthesis, the use of microfluidic devices, has emerged as a new method for producing chemical substances with high efficiency [11-13]. Now, the introduction of continuous-flow synthesis technique to laboratory synthesis represents a highly useful and increasingly popular method in organic chemistry [14-17]. Flow microreactor systems serve as an effective method for precise control of chemical reactions. Not only operational safety, but also extremely fast mixing, efficient heat transfer, and precise residence time control by virtue of the characteristic features of microstructures are responsible for their effectiveness. In particular, brilliant works of the generation and reactions of reactive intermediates that cannot be done in batch reactors have been developed by means of ‘space integration methodology’, where a sequence of reactions is conducted in one flow by adding the reagents at different places in continuous-flow synthesis [18-25].

This review deals with the successful examples on synthesis and reactions of fluorine-containing molecules by the use of flow microreactor systems. Useful applications using flow microreactor technology to overcome long-standing problems in synthetic organofluorine chemistry are showcased.

Reactions using hazardous fluorinating reagents

Direct fluorination employing elemental fluorine (F_2) is one of the most straightforward methods to make fluorine-containing molecules with high atom economy. However, handling F_2 needs special care and there are a lot of practical difficulties associated with direct fluorination. Elemental fluorine is a poisonous pale yellow gas at room temperature (bp $-188\text{ }^\circ\text{C}$). Reactions of organic substances with elemental fluorine are typically strongly exothermic and extremely fast, frequently explosive. So it is difficult to control direct fluorination reactions with F_2 gas in conventional batch reactors. In 1999, the pioneering work using flow microreactor technology for direct fluorination was reported by Chambers and Spink (Scheme 1) [26]. Utilizing the flow microreactor system, selective fluorination reactions were accomplished. For instance, fluorination of β -dicarbonyl compounds proceeds with high efficiency, whereas the use of conventional macrobatch systems suffered from low conversion [27,28]. Since then, direct fluorination processes using flow microreactor systems have been studied extensively [29-36]. The reactions of arenes with F_2 gas cause not only substitution (aromatic fluorination) but also side reac-

tions such as fluorine-addition, polymerization and so on due to the high reactivity of F_2 gas [37-40]. Direct fluorination of aromatics in microreactor system took place cleanly [36].

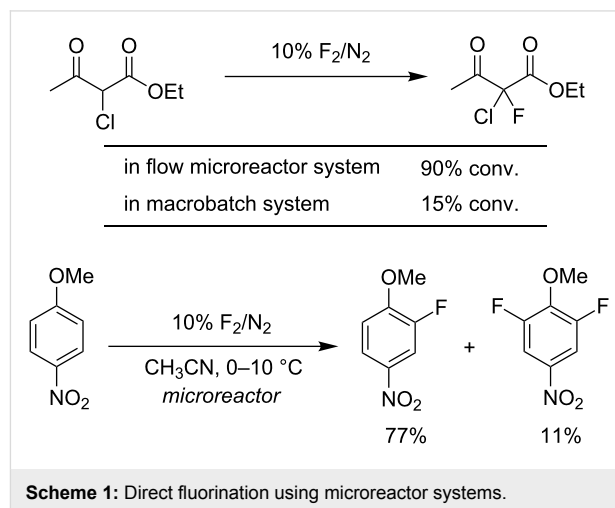

As another splendid example for safe handling of hazardous fluorinating reagents, the flow microreactor synthesis using diethylaminosulfur trifluoride (Et_2NSF_3 , abbreviated as DAST) was demonstrated. DAST is a commercially available liquid reagent that is utilized for the conversion of alcohols and carbonyl compounds into the corresponding fluoro derivatives. In spite of the effectiveness and convenience for nucleophilic fluorination, DAST is volatile and quite moisture sensitive, and readily undergoes disproportionation to SF_4 and explosive $(Et_2N)_2SF_2$ when heating at over $90\text{ }^\circ\text{C}$ [41-43]. Therefore, special care is required in handling a large quantity of DAST concerning the danger of the explosion under heating conditions. To solve these technical issues, the use of DAST in a continuous-flow reactor employing inert plastic flow tubes provided flexibility, scale-up production, and improved safety of operation. Using flow chemistry, the conversion of alcohols to fluorides was achieved by Seeberger and Ley, independently (Scheme 2) [44-47]. Usually, *gem*-difluorination of ketones by DAST is known to be less efficient because it needs heating and/or long reaction time to complete the fluorination [48,49]. Nevertheless by the use of a flow microreactor device, isatin underwent *gem*-difluorination to give the corresponding difluoride in 73% yield (residence time in the reactor: within 1 h).

Reactions that can be well-controlled and accelerated using flow microreactor systems

The success of continuous flow chemistry in organic synthesis has enlarged rapidly last decade. There have been numerous examples using flow microreactors with improvement of chemical conversions and selectivities compared to conventional batch equipments. There are several beneficial effects using of

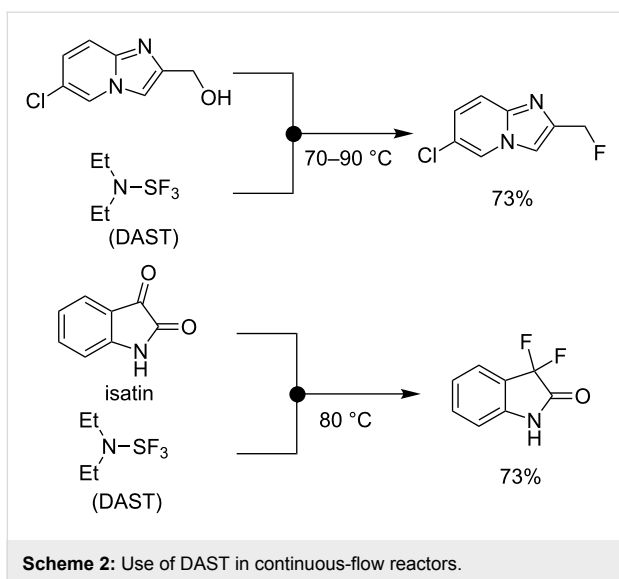

flow microreactor systems; for instance, extremely fast mixing ability attributed to shortened diffusion path length, and highly efficient heat transfer ability based on large surface-area-to-

volume ratio. In some cases, product selectively can be enhanced dramatically by the use of continuous flow microreactor devices. Daikin Industries, Ltd. developed the flow microreactor synthesis of fluorinated epoxides. In the first step (radical addition of perfluoroalkyl iodides to unsaturated alcohols), there is a problem concerning the violent exothermic reaction induced by decomposition of AIBN [50]. Furthermore, in the second step (intramolecular nucleophilic substitution of β -iodoalcohols to afford epoxides), efficient mixing technique is required for biphasic aqueous–organic systems. To resolve all the troublesome issues, flow microreactor provided improved reaction control over traditional batch reactors; high-yield synthesis of fluorinated epoxides was achieved (Scheme 3).

Kitazume et al. demonstrated the benefit of flow microreactors for a highly stereoselective synthesis of difluoromethylated alkenes [51]. They succeeded in perfect control of rapid base-catalyzed isomerization to give (*E*)-ethyl 3-difluoromethylpropenates (Scheme 4). Due to the benefit of temperature control in flow microreactor, further isomerization affording **B** was restricted.

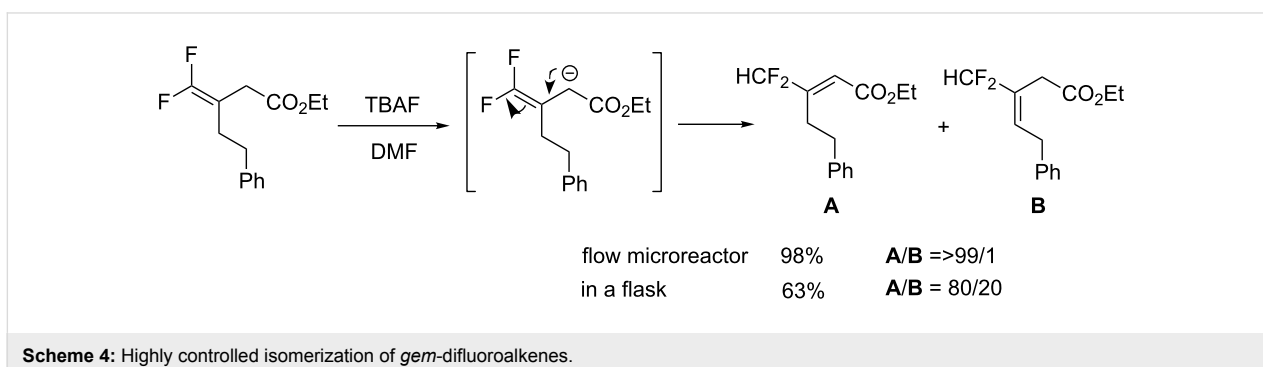
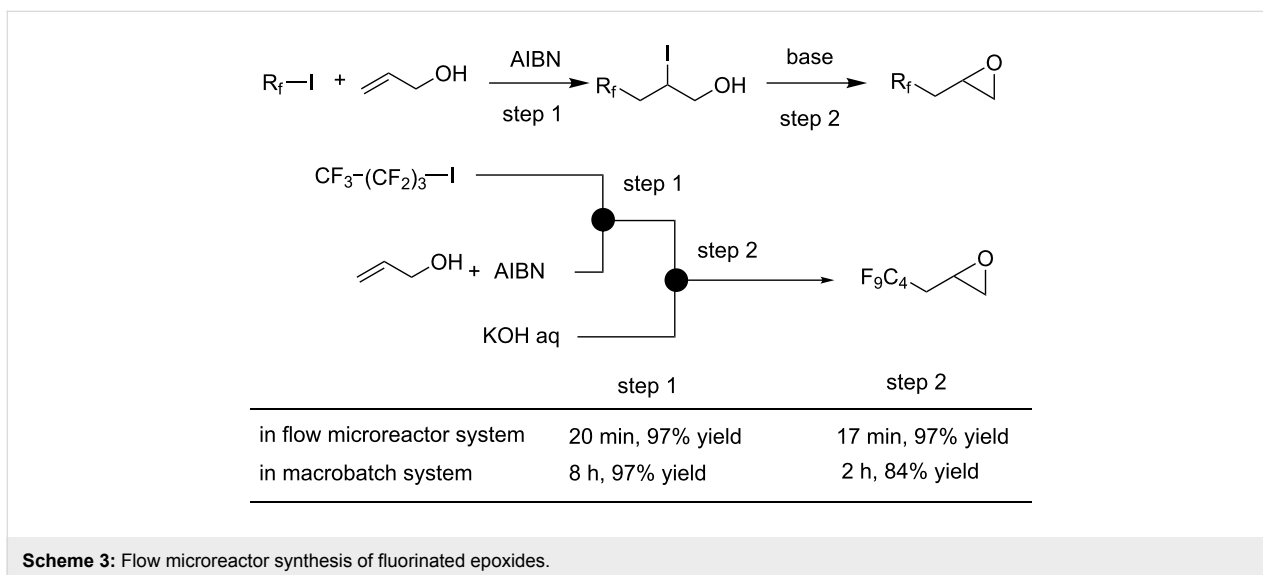

The Pd-catalyzed fluorination of aryl triflates with fluoride was developed by Buchwald and co-workers in 2009 [52]. Both electron-rich and -poor aryl triflates underwent Pd-catalyzed aromatic fluorination. As a fluoride source, they used CsF, which is an expensive reagent. They found that the use of a large excesses of CsF shortened reaction times for catalytic aromatic fluorination. Furthermore, efficient mixing becomes difficult when dealing with large quantities of insoluble CsF. They invented a packed-bed flow reactor, which allowed for easy handling of large quantities of insoluble CsF with efficient mixing (Scheme 5) [53].

As an alternative method for aromatic fluorination, Yoshida and Nagaki reported the reactions of aryllithiums with electrophilic fluorinating agents such as NFSI and *N*-fluorosultam (Scheme 6) [54]. The present flow microreactor method showed a high level of functional group compatibility; a wide repertoire of aryl fluorides possessing electron-withdrawing, electron-

donating, and sterically hindered functional groups were obtained in good yields. This is an important feature of 'late-stage fluorination methodology' for efficient drug screening.

[¹⁸F] is a fluorine radioisotope which acts as an important source of positrons. In the medical imaging modality, [¹⁸F]FDG is radiopharmaceutically used for positron emission tomography (PET). However, due to the short radioactivity elimination half-life of [¹⁸F] (*t*_{1/2} = 110 min), protocols for rapid and selective synthesis of [¹⁸F]-labeled compounds have been required. In addition, on-site and on-demand chemical production of PET agents with automation and ease of in-line purification is suitable for hospital use. To date, continuous flow microreactor technology has shown potential for synthesis of [¹⁸F]-radiolabeled molecular imaging probes such as [¹⁸F]FDG, [¹⁸F]fallypride, [¹⁸F]annexin, and so on, which were made by nucleophilic substitution reactions using [¹⁸F]-fluoride ion (Scheme 7) [55-67].

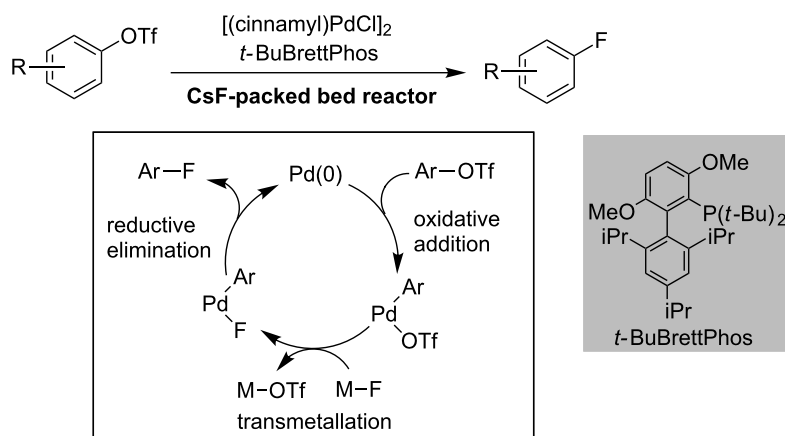

Scheme 5: Flow system for catalytic aromatic fluorination.

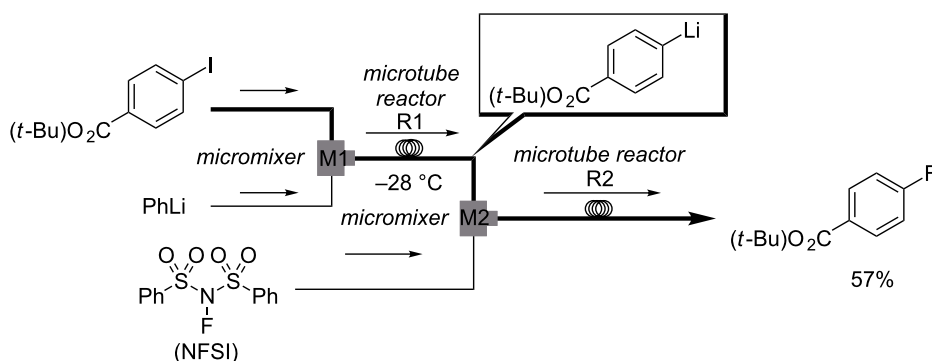

Scheme 6: Continuous-flow reactor for electrophilic aromatic fluorination.

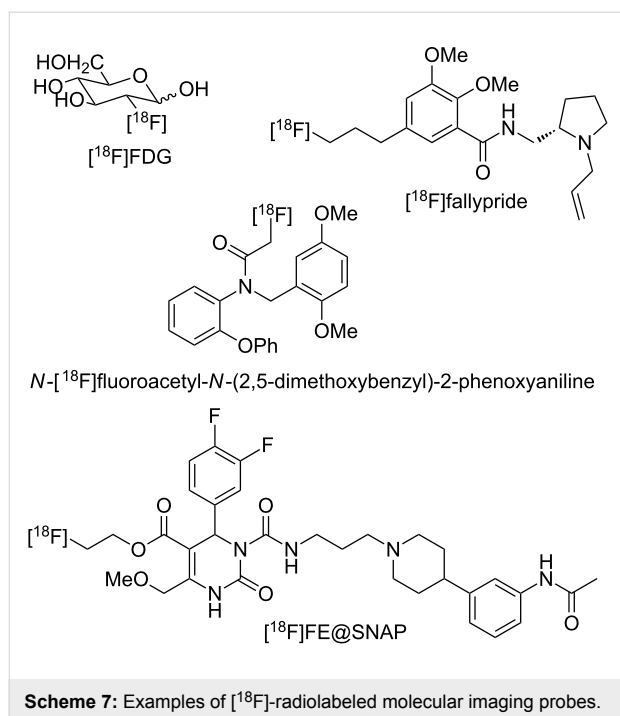

For not only fluorination/fluoroalkylation, but also for defluorination, flow microreactor synthesis is quite effective. Defluorination involving a nucleophilic addition–elimination mechanism is a fundamental reaction in organic synthesis. Acid fluo-

rides are known to be more stable to hydrolysis than acid chlorides under acidic or neutral conditions; on the other hand, they react with nucleophiles vigorously under basic conditions. Amino acid fluorides serve as one of the most efficient reagents for peptide bond formation. Seeberger and co-workers demonstrated the use of a silicon-based microreactor for the effective synthesis of peptides (Scheme 8) [68]. The condensation reaction completed in only 3 min at 90 °C to afford the dipeptide in high yield. Under the conditions at higher temperatures and/or leaving in prolonged contact with the reagents, decreasing the chemical yield of the desired dipeptide and increasing the amount of the tripeptide were observed. Using a flow microreactor system, precise residence-time control avoided the formation of undesired tripeptide byproduct.

Nucleophilic aromatic substitution ($\text{S}_{\text{N}}\text{Ar}$) chemistry contributes to creating useful materials. In 2005, Comer and Organ reported $\text{S}_{\text{N}}\text{Ar}$ reactions of 2-fluoronitrobenzene using a flow microreactor system with microwave irradiation (Scheme 9) [69]. Toward making compound-libraries, Schwalbe explored a flow microreactor system for sequential transformation towards fluoroquinolone antibiotics such as ciprofloxacin via both inter- and intramolecular $\text{S}_{\text{N}}\text{Ar}$ reactions (Scheme 10) [70]. Starting from the acylation reaction of (*N*-dimethylamino)acrylate with 2,4,5-trifluorobenzoic acid chloride, followed by two kinds of library diversification involving 1)

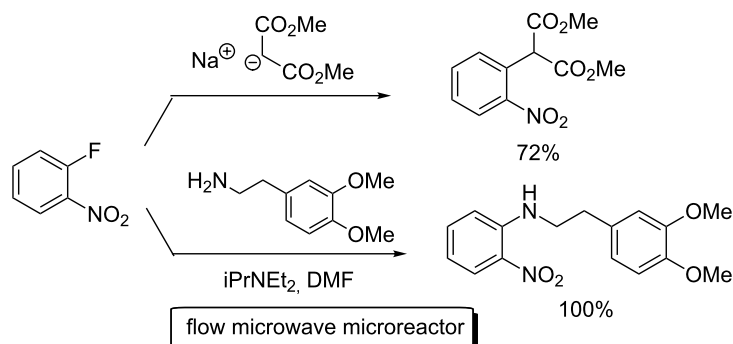
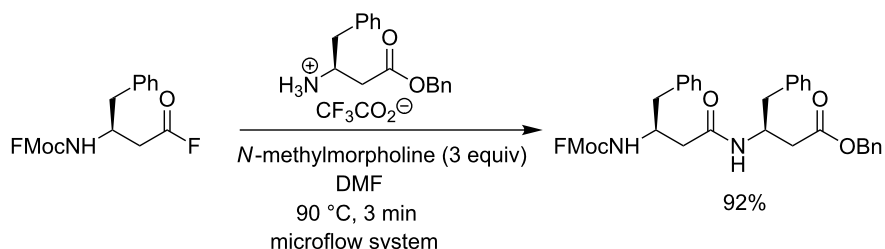

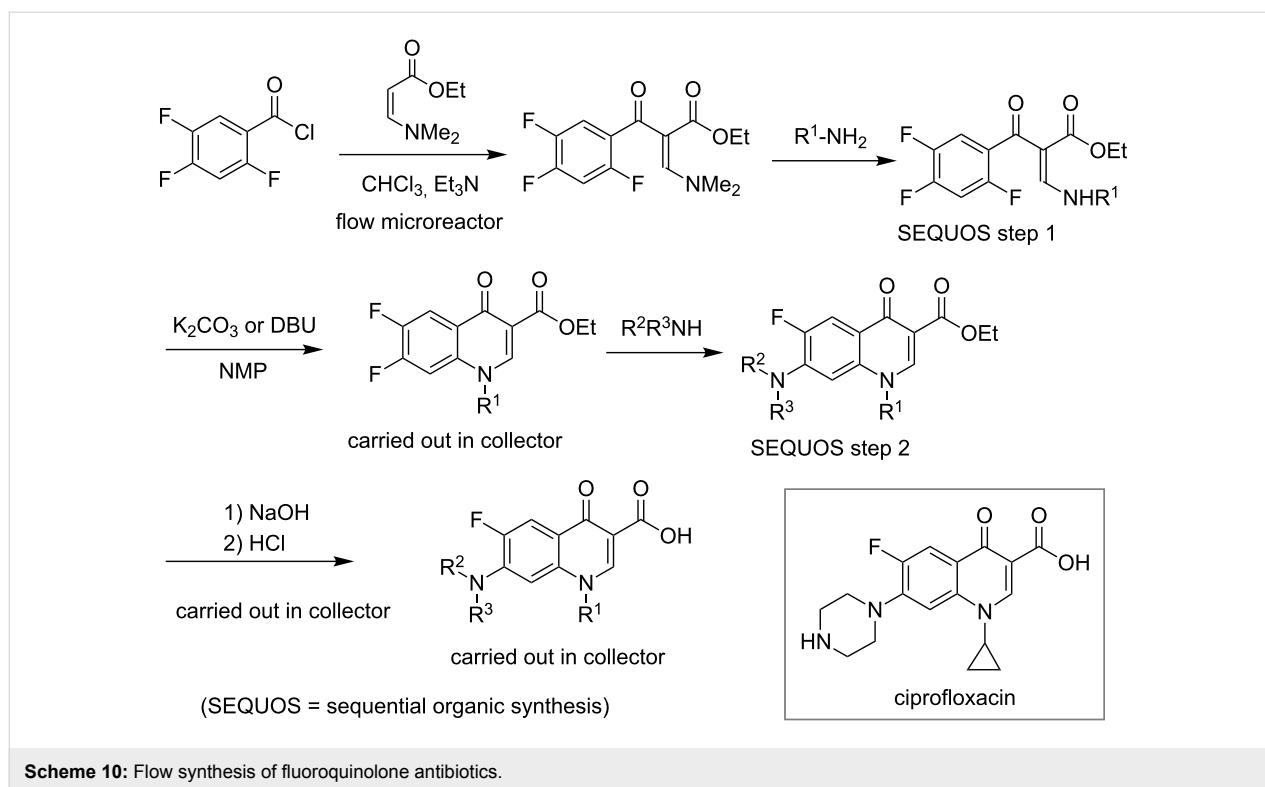

Michael addition of a set of primary amines and the subsequent nucleophilic ring closure to give the difluoroquinolone system, 2) intermolecular nucleophilic aromatic substitution with various amines and hydrolysis of ester moieties to afford a number of ciprofloxacin analogues in good overall yields with high purity.

Reactions in which a reactive intermediate easily decomposes in batch reactors

As aforementioned, the benefits of flow microreactor synthesis are 1) accurate control of reaction time, temperature, and pressure, 2) efficient mixing, 3) improved product selectivity (yield and purity), 4) rapid removal of heat of reaction for increased process safety, 5) ease of scale-up from lab to plant scale, and so on.

The reaction times are governed by the residence times (concerning path lengths and flow rates) inside flow microre-

actor which allow the generation and reactions of reactive intermediates before decomposition. By virtue of these characteristic features, the residence time control in flow microreactors makes the generation of highly reactive species possible, including their reactions on a preparative scale within a second or less.

Pentafluorophenylmagnesium bromide (PFPMgBr) is industrially produced by means of the halogen–metal exchange reaction of ethylmagnesium bromide and bromopentafluorobenzene [71]. However, this process is a highly exothermic reaction, and therefore, the use of a slow addition technique is required to avoid rapid increase in temperature. The flow reactor systems with micromixer and microheat exchangers show efficacy of forming PFPMgBr (Scheme 11) [72]. In the well-controlled formation of PFPMgBr and the subsequent protonation, continuous running of the pilot plant-scale flow microreactor gave pentafluorobenzene (PFB) in 92% yield (14.7 kg).

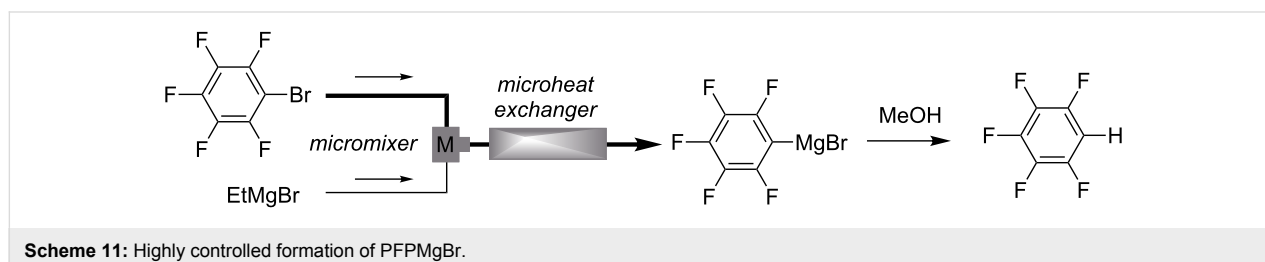

Molecular switches based on photochromic diarylethenes are one of the most promising electronic materials [73]. In particular, a number of 1,2-bis(heteroaryl)-substituted perfluorocyclopentenes have been synthesized for use as photosensitive components of photochromic recording media for optical memory. For the synthesis of 1,2-diarylperfluorocyclopentenes, octafluorocyclopentene undergoes very quick reaction with nucleophiles because of the extremely high electrophilicity of the double bond [74]. The nucleophilic substitutions take place in a stepwise manner via an addition–elimination pathway. However, it is difficult to synthesize unsymmetrical diarylethenes with conventional macro batch systems because of contamination of the symmetrical diarylethenes (two identical nucleophiles are incorporated at the same time). Integrated flow microreactor synthesis of photochromic diarylethenes was found to be effective; the generation of heteroaryllithiums and the subsequent nucleophilic addition/elimination with octafluorocyclopentene were successfully achieved (Scheme 12) [75]. As a significant progress, the selective synthesis of unsymmetrical diarylethenes was accomplished by stepwise introduction of different heteroaryl nucleophiles into octafluorocyclopentene with highly controlled manner [76].

The installation of perfluoroalkyl moieties into organic molecules can substantially changes the electronic properties of the parent organic compounds, and improves lipophilicity leading to enhanced solubility in fatty tissue and more efficient transport in the body. Nucleophilic introduction of perfluoroalkyl (R_F) groups are one of the most effective and general methods for the synthesis of perfluoroalkylated compounds [77]. Perfluoroalkyllithiums, which are usually prepared by halogen–lithium exchange reactions of perfluoroalkyl halides with alkyllithiums are useful for nucleophilic perfluoroalkylation [78], however they readily undergo β -elimination to form

perfluoroalkenes [79]. Flow microreactor systems were proved to be effective for generation and reactions of R_FLi avoiding the β -elimination [80]. In the case of benzaldehyde as an electrophile, the reactions could be conducted at 0 °C, although much lower temperatures such as -78 °C are required to avoid the decomposition of perfluoroalkyllithium intermediates in batch processes (Scheme 13). However, the use of highly reactive electrophiles such as trimethylsilyl triflate and chlorotributylstannane gave rise to very low yields of the desired products, because the reactions of $MeLi$ with such electrophiles are faster than those with perfluoroalkyl halides. In such cases, the generation of R_FLi and the reactions with electrophiles should be separated to give the desired R_FSiMe_3 and R_FSnBu_3 in high yields. To solve the issue, the use of the integrated flow microreactor system was effective; well-controlled generation of highly reactive R_FLi intermediates in the absence of active electrophiles and transfer of R_FLi into the next step were accomplished by taking short residence times in the reactors before they decomposed (Scheme 14).

Conclusion

The illustrious achievements have been made in developing organic reactions by the use of flow microreactor devices. Fluorinated organic compounds have been gaining a significant importance in wide field of science and technology, and there have been the associated growing need for new and more efficient synthetic methods. As highlighted here, each of these elegant flow microreactor syntheses surely supplies the innovative methods for the synthesis of organo-fluorine compounds. For the future, continuous flow microreactor chemistry will make a breakthrough in developing new chemical production with highly efficiency and unexploited fluorinated intermediates by the ingenious strategy, and will afford fluorine-containing useful materials.

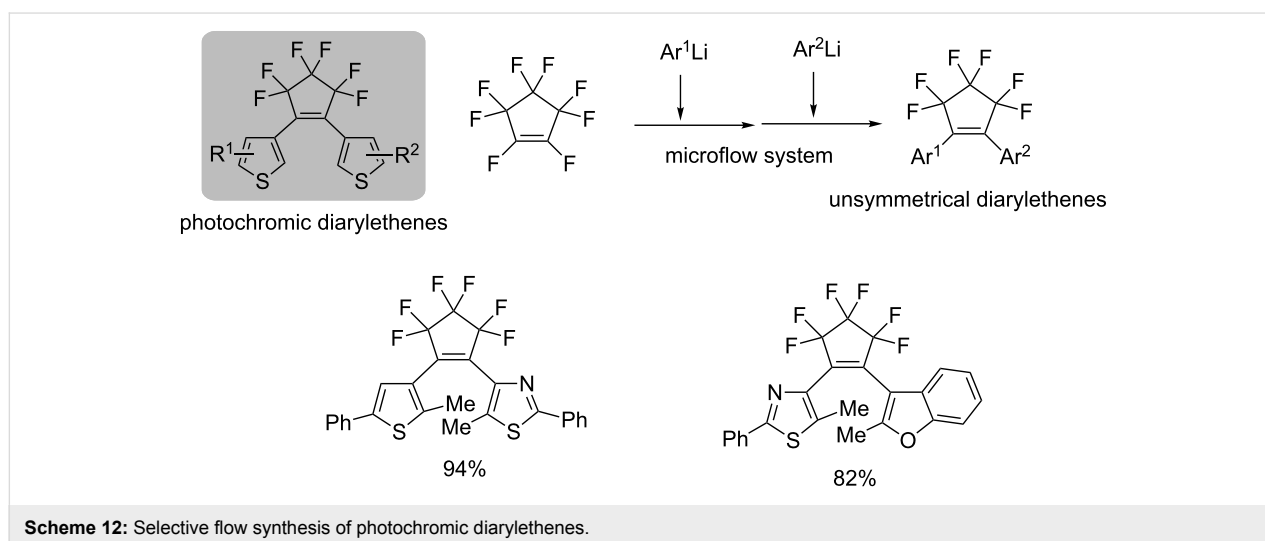

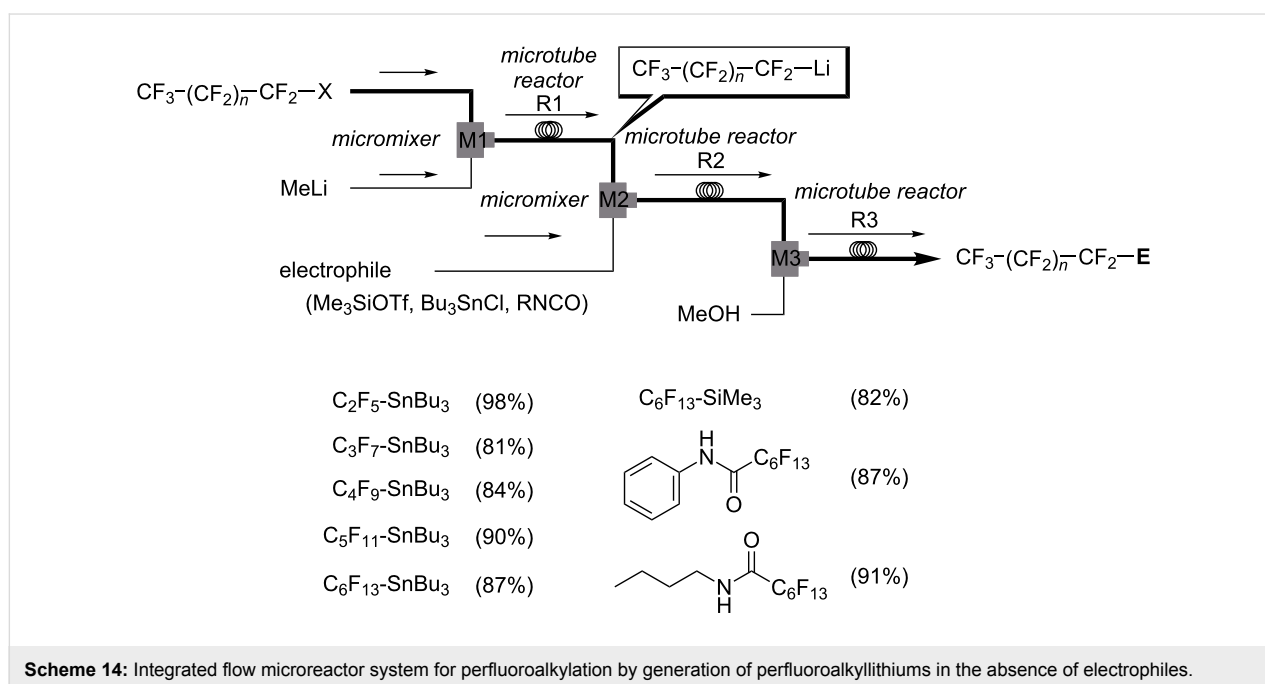
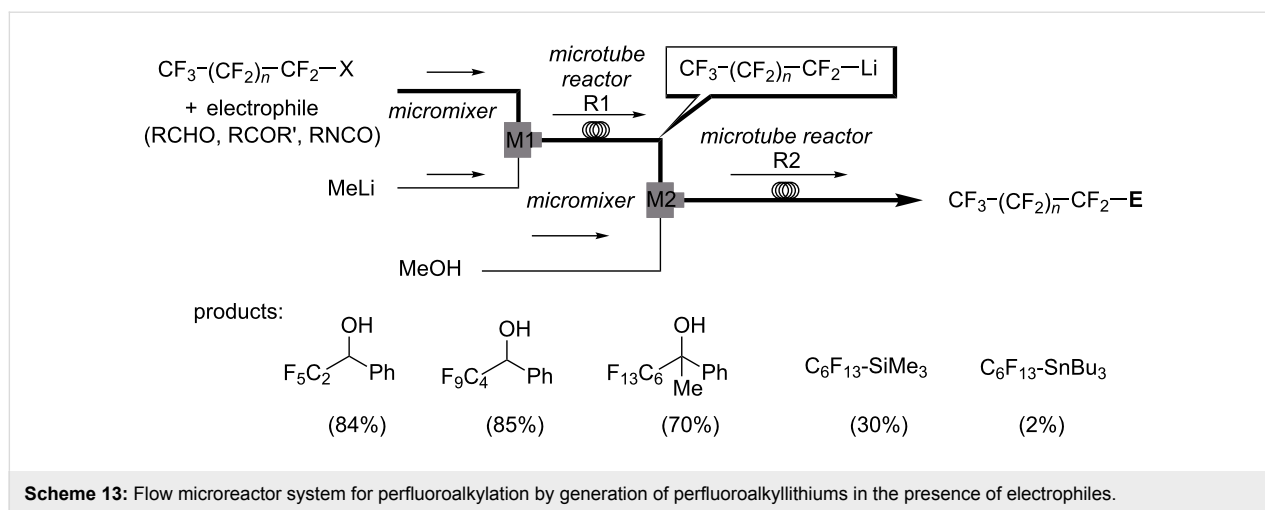

Acknowledgements

The financial support of the Ministry of Education, Culture, Sports, Science and Technology of Japan (Grant-in-Aid for Scientific Research on Innovative Areas "Organic Synthesis Based on Reaction Integration") is gratefully acknowledged.

References

- Banks, R. E.; Smart, B. E.; Tatlow, J. C. *Organofluorine Chemistry: Principles and Commercial Applications*; Plenum Press: New York, 2000.
- Hiyama, T.; Kanie, K.; Kusumoto, T.; Morizawa, Y.; Shimizu, M. *Organofluorine Compounds: Chemistry and Application*; Springer-Verlag: Berlin, 2000. doi:10.1007/978-3-662-04164-2
- Kirsch, P. *Modern Fluoroorganic Chemistry*; Wiley-VCH: Weinheim, 2004. doi:10.1002/352760393X
- Chambers, R. D. *Fluorine in Organic Chemistry*; Blackwell: Oxford, 2004. doi:10.1002/9781444305371
- Uneyama, K. *Organofluorine Chemistry*; Blackwell: Oxford, 2006. doi:10.1002/9780470988589
- Bégué, J.-P.; Bonnet-Delpon, D. *Bioorganic and Medicinal Chemistry of Fluorine*; John Wiley & Sons, Inc.: Hoboken, NJ, 2008. doi:10.1002/9780470281895
- Ojima, I. *Fluorine in Medicinal Chemistry and Chemical Biology*; Wiley-Blackwell: Chichester, West Sussex, 2009.
- Gouverneur, V.; Müller, K., Eds. *Fluorine in Pharmaceutical and Medicinal Chemistry: From Biophysical Aspects to Clinical Applications*; World Scientific Publishing Company: London, 2012. doi:10.1142/p746
- Thayer, A. M. *Chem. Eng. News* **2006**, *84*, 15–24.
- Hagmann, W. K. *J. Med. Chem.* **2008**, *51*, 4359–4369. doi:10.1021/jm800219f

11. Yoshida, J. *Flash Chemistry: Fast Organic Synthesis in Microsystems*; Wiley: Chichester, West Sussex, 2008.
12. Wiles, C.; Watts, P. *Micro Reaction Technology in Organic Synthesis*; CRC Press: Boca Raton, FL, 2011.
13. Wirth, T., Ed. *Microreactors in Organic Chemistry and Catalysis*; Wiley-VCH: Weinheim, 2013. doi:10.1002/9783527659722
14. Yoshida, J.; Nagaki, A.; Yamada, D. *Drug Discovery Today* **2013**, *10*, e53–e59. doi:10.1016/j.ddtec.2012.10.013
15. Yoshida, J. *Chem. Rec.* **2010**, *10*, 332–341. doi:10.1002/tcr.201000020
16. McQuade, D. T.; Seeberger, P. H. *J. Org. Chem.* **2013**, *78*, 6384–6389. doi:10.1021/jo400583m
17. Schwalbe, T.; Simons, K. *Chim. Oggi* **2006**, *24*, 56–61.
18. Suga, S.; Yamada, D.; Yoshida, J. *Chem. Lett.* **2010**, *39*, 404–406. doi:10.1246/cl.2010.404
19. Yoshida, J.; Saito, K.; Nokami, T.; Nagaki, A. *Synlett* **2011**, 1189–1194. doi:10.1055/s-0030-1259946
20. Nagaki, A.; Kim, H.; Usutani, H.; Matsuo, C.; Yoshida, J. *Org. Biomol. Chem.* **2010**, *8*, 1212–1217. doi:10.1039/b919325c
21. Tomida, Y.; Nagaki, A.; Yoshida, J. *J. Am. Chem. Soc.* **2011**, *133*, 3744–3747. doi:10.1021/ja110898s
22. Nagaki, A.; Kim, H.; Yoshida, J. *Angew. Chem., Int. Ed.* **2008**, *47*, 7833–7836. doi:10.1002/anie.200803205
23. Usutani, H.; Tomida, Y.; Nagaki, A.; Okamoto, H.; Nokami, T.; Yoshida, J. *J. Am. Chem. Soc.* **2007**, *129*, 3046–3047. doi:10.1021/ja068330s
24. Kim, H.; Nagaki, A.; Yoshida, J. *Nat. Commun.* **2011**, *2*, No. 264. doi:10.1038/ncomms1264
25. Saito, K.; Ueoka, K.; Matsumoto, K.; Suga, S.; Nokami, T.; Yoshida, J. *Angew. Chem., Int. Ed.* **2011**, *50*, 5153–5156. doi:10.1002/anie.201100854
26. Chambers, R. D.; Spink, R. C. H. *Chem. Commun.* **1999**, 883–884. doi:10.1039/a901473j
27. Chambers, R. D.; Greenhall, M. P.; Hutchinson, J. *J. Chem. Soc., Chem. Commun.* **1995**, 21–22. doi:10.1039/C39950000021
28. Chambers, R. D.; Greenhall, M. P.; Hutchinson, J. *Tetrahedron* **1996**, *52*, 1–8. doi:10.1016/0040-4020(95)00883-A
29. Chambers, R. D.; Sandford, G. *Chim. Oggi* **2004**, *22*, 6–8.
30. Jähnisch, K.; Baerns, M.; Hessel, V.; Ehrfeld, W.; Haverkamp, V.; Löwe, H.; Wille, C.; Guber, A. *J. Fluorine Chem.* **2000**, *105*, 117–128. doi:10.1016/S0022-1139(00)00300-6
31. Chambers, R. D.; Holling, D.; Spink, R. C. H.; Sandford, G. *Lab Chip* **2001**, *1*, 132–137. doi:10.1039/b108841f
32. Löb, P.; Löwe, H.; Hessel, V. *J. Fluorine Chem.* **2004**, *125*, 1677–1694. doi:10.1016/j.jfluchem.2004.09.006
33. Chambers, R. D.; Fox, M. F.; Sandford, G. *Lab Chip* **2005**, *5*, 1132–1139. doi:10.1039/b504675k
34. Sato, T. Preparation of fluorinated organic compounds by direct fluorination. Jpn. Kokai Tokkyo Koho JP 2006-001881, Jan 5, 2006.
35. de Mas, N.; Günther, A.; Schmidt, M. A.; Jensen, K. F. *Ind. Eng. Chem. Res.* **2009**, *48*, 1428–1434. doi:10.1021/ie801232d
36. Chambers, R. D.; Fox, M. A.; Sandford, G.; Trmcić, J.; Goeta, A. *J. Fluorine Chem.* **2007**, *128*, 29–33. doi:10.1016/j.jfluchem.2006.09.010
37. Hessel, V.; Angeli, P.; Gavriilidis, A.; Löwe, H. *Ind. Eng. Chem. Res.* **2005**, *44*, 9750–9769. doi:10.1021/ie0503139
And references therein.
38. Grakauskas, V. *J. Org. Chem.* **1969**, *34*, 2835–2839. doi:10.1021/jo01262a009
39. Cacace, F.; Giacomello, P.; Wolf, A. P. *J. Am. Chem. Soc.* **1980**, *102*, 3511–3515. doi:10.1021/ja00530a034
40. Purrington, S. T.; Woodard, D. L. *J. Org. Chem.* **1991**, *56*, 142–145. doi:10.1021/jo00001a029
41. Messina, P. A.; Mange, K. C.; Middleton, W. J. *J. Fluorine Chem.* **1989**, *42*, 137–143. doi:10.1016/S0022-1139(00)83974-3
42. von Allenstein, E.; Schrempf, G. *Z. Anorg. Allg. Chem.* **1981**, 474, 7–17.
43. Lal, G. S.; Pez, G. P.; Pesaresi, R. J.; Prozonic, F. M.; Cheng, H. *J. Org. Chem.* **1999**, *64*, 7048–7054. doi:10.1021/jo990566+
44. Gustafsson, T.; Gilmour, R.; Seeberger, P. H. *Chem. Commun.* **2008**, 3022–3024. doi:10.1039/b803695k
45. Baumann, M.; Baxendale, I. R.; Ley, S. V. *Synlett* **2008**, 2111–2114. doi:10.1055/s-2008-1078026
46. Baumann, M.; Baxendale, I. R.; Martin, L. J.; Ley, S. V. *Tetrahedron* **2009**, *65*, 6611–6625. doi:10.1016/j.tet.2009.05.083
47. Carter, C. F.; Lange, H.; Ley, S. V.; Baxendale, I. R.; Wittkamp, B.; Goode, J. G.; Gaunt, N. L. *Org. Process Res. Dev.* **2010**, *14*, 393–404. doi:10.1021/op900305v
48. Torres, J. C.; Garden, S. J.; Pinto, A. C.; da Silva, F. S. Q.; Boechat, N. *Tetrahedron* **1999**, *55*, 1881–1892. doi:10.1016/S0040-4020(98)01229-0
49. Li, G.; van der Donk, W. A. *Org. Lett.* **2007**, *9*, 41–44. doi:10.1021/ol062401a
50. Taguchi, M.; Nakaya, H.; Ichihara, K.; Senba, Y.; Hiraga, Y. Manufacture of fluorine-containing epoxides from fluoroalkyl iodides and unsaturated alcohols. Jpn. Kokai Tokkyo Koho JP 2009-67687, April 2, 2009.
51. Kitazume, T.; Kawai, K.; Nihei, T.; Miyake, N. *J. Fluorine Chem.* **2005**, *126*, 59–62. doi:10.1016/j.jfluchem.2004.10.008
52. Watson, D. A.; Su, M.; Teverovskiy, G.; Zhang, Y.; Garcia-Fortanet, J.; Kinzel, T.; Buchwald, S. L. *Science* **2009**, *325*, 1661–1664. doi:10.1126/science.1178239
53. Noël, T.; Maimone, T. J.; Buchwald, S. L. *Angew. Chem., Int. Ed.* **2011**, *50*, 8900–8903. doi:10.1002/anie.201104652
54. Nagaki, A.; Uesugi, Y.; Kim, H.; Yoshida, J. *Chem.–Asian J.* **2013**, *8*, 705–708. doi:10.1002/asia.201201191
55. Lee, C.-C.; Sui, G.; Elizarov, A.; Shu, C. J.; Shin, Y.-S.; Dooley, A. N.; Huang, J.; Daridon, A.; Wyatt, P.; Stout, D.; Kolb, H. C.; Witte, O. N.; Satyamurthy, N.; Heath, J. R.; Phelps, M. E.; Quake, S. R.; Tseng, H.-R. *Science* **2005**, *310*, 1793–1796. doi:10.1126/science.1118919
56. Elizarov, A. M.; van Dam, R. M.; Shin, Y. S.; Kolb, H. C.; Padgett, H. C.; Stout, D.; Shu, J.; Huang, J.; Daridon, A.; Heath, J. R. *J. Nucl. Med.* **2010**, *51*, 282–287. doi:10.2967/jnumed.109.065946
57. Gillies, J. M.; Prenant, C.; Chimon, G. N.; Smethurst, G. J.; Dekker, B. A.; Zweit, J. *Appl. Radiat. Isot.* **2006**, *64*, 333–336. doi:10.1016/j.apradiso.2005.08.009
58. Steel, C. J.; O'Brien, A. T.; Luthra, S. K.; Brady, F. *J. Labelled Compd. Radiopharm.* **2007**, *50*, 308–311. doi:10.1002/jlcr.1259
59. Gillies, J. M.; Prenant, C.; Chimon, G. N.; Smethurst, G. J.; Perrie, W.; Hamblett, I.; Dekker, B.; Zweit, J. *Appl. Radiat. Isot.* **2006**, *64*, 325–332. doi:10.1016/j.apradiso.2005.08.007
60. Lu, S.; Giamis, A. M.; Pike, V. W. *Curr. Radiopharm.* **2009**, *2*, 49–55. doi:10.2174/1874471010902010049
61. Briard, E.; Zoghbi, S. S.; Siméon, F. G.; Imaizumi, M.; Gourley, J. P.; Shetty, H. U.; Lu, S.; Fujita, M.; Innis, R. B.; Pike, V. W. *J. Med. Chem.* **2009**, *52*, 688–699. doi:10.1021/jm8011855

62. Lu, S.-Y.; Watts, P.; Chin, F. T.; Hong, J.; Musachio, J. L.; Briard, E.; Pike, V. W. *Lab Chip* **2004**, *4*, 523–525. doi:10.1039/b407938h
63. Pascali, G.; Mazzone, G.; Saccomanni, G.; Manera, C.; Salvadori, P. A. *Nucl. Med. Biol.* **2010**, *37*, 547–555. doi:10.1016/j.nucmedbio.2010.03.006
64. Pascali, G.; Nannavecchia, G.; Pitzianti, S.; Salvadori, P. A. *Nucl. Med. Biol.* **2011**, *38*, 637–644. doi:10.1016/j.nucmedbio.2011.01.005
65. Chun, J.-H.; Lu, S.; Lee, Y.-S.; Pike, V. W. *J. Org. Chem.* **2010**, *75*, 3332–3338. doi:10.1021/jo100361d
66. Philippe, C.; Ungersboeck, J.; Schirmer, E.; Zdravkovic, M.; Nics, L.; Zeilinger, M.; Shanab, K.; Lanzenberger, R.; Karanikas, G.; Spreitzer, H.; Viernstein, H.; Mitterhauser, M.; Wadsak, W. *Bioorg. Med. Chem.* **2012**, *20*, 5936–5940. doi:10.1016/j.bmc.2012.07.051
67. Keng, P. Y.; Chen, S.; Ding, H.; Sadeghi, S.; Shah, G. J.; Dooraghi, A.; Phelps, M. E.; Satyamurthy, N.; Chatziioannou, A. F.; Kim, C.-J.; van Dam, R. M. *Proc. Natl. Acad. Sci. U. S. A.* **2012**, *109*, 690–695. doi:10.1073/pnas.1117566109
68. Flögel, O.; Codée, J. D. C.; Seebach, D.; Seeberger, P. H. *Angew. Chem., Int. Ed.* **2006**, *45*, 7000–7003. doi:10.1002/anie.200602167
69. Comer, E.; Organ, M. G. *J. Am. Chem. Soc.* **2005**, *127*, 8160–8167. doi:10.1021/ja0512069
70. Schwalbe, T.; Kadzimirsz, D.; Jas, G. *QSAR Comb. Sci.* **2005**, *24*, 758–768. doi:10.1002/qsar.200540005
71. Respass, W. L.; Tamborski, C. *J. Organomet. Chem.* **1968**, *11*, 619–622. doi:10.1016/0022-328X(68)80092-0
72. Wakami, H.; Yoshida, J. *Org. Process Res. Dev.* **2005**, *9*, 787–791. doi:10.1021/op0501500
73. Irie, M. *Chem. Rev.* **2000**, *100*, 1685–1716. doi:10.1021/cr980069d
74. Amii, H.; Uneyama, K. *Chem. Rev.* **2009**, *109*, 2119–2183. doi:10.1021/cr800388c
75. Ushioji, Y.; Hase, T.; Iinuma, Y.; Takata, A.; Yoshida, J. *Chem. Commun.* **2007**, 2947–2949. doi:10.1039/b702277h
76. Asai, T.; Takata, A.; Nagaki, A.; Yoshida, J. *ChemSusChem* **2012**, *5*, 339–350. doi:10.1002/cssc.201100376
77. Schwalbe, T.; Autze, V.; Hohmann, M.; Stirner, W. *Org. Process Res. Dev.* **2004**, *8*, 440–454. doi:10.1021/op049970n
See for a Grignard exchange reaction of C₂F₅I with MeMgCl followed by reaction with benzophenone in a microflow system.
78. Uno, H.; Suzuki, H. *Synlett* **1993**, 91–96. doi:10.1055/s-1993-22361
79. Uneyama, K.; Katagiri, T.; Amii, H. *Acc. Chem. Res.* **2008**, *41*, 817–829. doi:10.1021/ar7002573
80. Nagaki, A.; Tokuoka, S.; Yamada, S.; Tomida, Y.; Oshiro, K.; Amii, H.; Yoshida, J. *Org. Biomol. Chem.* **2011**, *9*, 7559–7563. doi:10.1039/c1ob06350b

License and Terms

This is an Open Access article under the terms of the Creative Commons Attribution License (<http://creativecommons.org/licenses/by/2.0>), which permits unrestricted use, distribution, and reproduction in any medium, provided the original work is properly cited.

The license is subject to the *Beilstein Journal of Organic Chemistry* terms and conditions: (<http://www.beilstein-journals.org/bjoc>)

The definitive version of this article is the electronic one which can be found at: [doi:10.3762/bjoc.9.314](https://doi.org/10.3762/bjoc.9.314)

Modulating NHC catalysis with fluorine

Yannick P. Rey^{1,2} and Ryan Gilmour^{*1,3}

Full Research Paper

Open Access

Address:

¹Organisch-Chemisches Institut, Westfälische Wilhelms-Universität Münster, Corrensstraße 40, 48149 Münster, Germany, ²Department of Chemistry and Applied Biosciences, ETH Zürich, Wolfgang-Pauli-Str. 10, 8093 Zürich, Switzerland, and ³Excellence Cluster EXC 1003, Cells in Motion, Münster, Germany

Email:

Ryan Gilmour^{*} - ryan.gilmour@uni-muenster.de

^{*} Corresponding author

Keywords:

catalysis; enantioselectivity; fluorine; gauche effect; organo-fluorine; Steglich rearrangement

Beilstein J. Org. Chem. **2013**, *9*, 2812–2820.

doi:10.3762/bjoc.9.316

Received: 30 August 2013

Accepted: 08 November 2013

Published: 06 December 2013

This article is part of the Thematic Series "Organo-fluorine chemistry III".

Guest Editor: D. O'Hagan

© 2013 Rey and Gilmour; licensee Beilstein-Institut.

License and terms: see end of document.

Abstract

Fluorination often confers a range of advantages in modulating the conformation and reactivity of small molecule organocatalysts. By strategically introducing fluorine substituents, as part of a β -fluoroamine motif, in a triazolium pre-catalyst, it was possible to modulate the behaviour of the corresponding *N*-heterocyclic carbene (NHC) with minimal steric alterations to the catalyst core. In this study, the effect of hydrogen to fluorine substitution was evaluated as part of a molecular editing study. X-ray crystallographic analyses of a number of derivatives are presented and the conformations are discussed. Upon deprotonation, the fluorinated triazolium salts generate catalytically active *N*-heterocyclic carbenes, which can then participate in the enantioselective Steglich rearrangement of oxazolyl carbonates to *C*-carboxylactones (e.r. up to 87.0:13.0).

Introduction

Molecular editing using fluorine is a powerful strategy to modulate the conformation and reactivity of small molecule organocatalysts [1-3]. The negligible steric penalty associated with H→F substitution, together with the polarised nature and stability of aliphatic C–F bonds, render this unit attractive from the perspective of molecular design [4]. The low-lying antibonding orbital (σ_{C-F}^*) can interact with an array of vicinal substituents ranging from non-bonding electron pairs, such as in the case of the fluorine anomeric effect [5], to electron rich sigma bonds ($\sigma \rightarrow \sigma^*$). The stereoelectronic gauche effect in 1,2-difluoroethane is the most prominent example (**1**; Figure 1) [6-9]. The counterintuitive preference of vicinal fluorine

substituents to adopt a gauche preference ($\Phi_{F-C-C-F} \approx 60^\circ$) can be rationalised by invoking two stabilising hyperconjugative interactions ($\sigma_{C-H} \rightarrow \sigma_{C-F}^*$). This conformational preference is conserved in numerous systems in which one of the fluorine atoms has been substituted by another electron withdrawing group ($X^{(\delta+)}; X^{(\delta+)}-C_\alpha-C_\beta-F^{\delta-}$). Often this modification leads to the introduction of a stabilising electrostatic component, thus enhancing the interaction: this is exemplified by the pioneering work of O'Hagan and co-workers [10-12].

In recent years, this laboratory has strategically employed the aforementioned effects in the design of functional small mole-

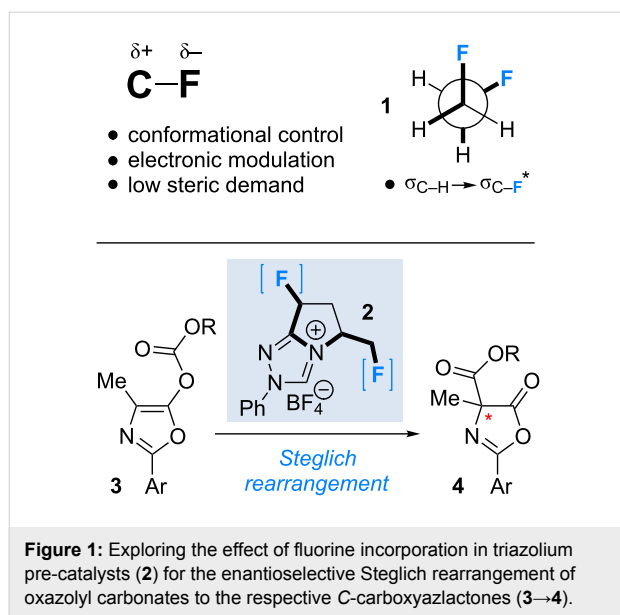

Figure 1: Exploring the effect of fluorine incorporation in triazolium pre-catalysts (**2**) for the enantioselective Steglich rearrangement of oxazolyl carbonates to the respective C-carboxylactones (**3**→**4**).

cules [13–22], often for application in organocatalysis [1]. Common to these studies has been the strategic incorporation of a fluoro substituent vicinal to a catalytically active amino group. Subsequent generation of a (partial) positive charge at nitrogen generates the requisite $\text{X-C}_\alpha\text{-C}_\beta\text{-F}^{\delta-}$ system ($\text{X} = \text{N}^+$), thus providing a facile approach to controlling rotation around this bond ($\Phi_{\text{XCCF}} \approx 60^\circ$). In this study, the influence of fluorination on catalyst behaviour is extended to the study of triazolium salts such as **2**, which can be converted to the respective *N*-heterocyclic carbenes (NHCs) by simple deprotonation.

Given the importance of NHCs in modern organic synthesis [23–28] it was envisaged that these systems would be intriguing candidates for investigation. Moreover, structural information gleaned from the triazolium salt pre-catalysts regarding con-

formation [18,22], assist in rationalising the behaviour of the NHCs generated in situ.

Herein, the synthesis and catalytic efficiency of a series of fluorinated, bicyclic triazolium salts **2** is disclosed. The effect of molecular editing by hydrogen to fluorine substitution is evaluated in the NHC-catalysed, enantioselective Steglich rearrangement of oxazolyl carbonates **3** to C-carboxylactones **4** [29], recently reported by Smith and co-workers [30–36].

Fluorination sites were selected based on their proximity to the ring junction nitrogen of the triazolium system (Figure 2). Consequently, two distinct β -fluoroamine sub-classes may be generated. The first site positions the β -fluorine atom on a freely rotatable ($\text{sp}^3\text{-sp}^3$) exo cyclic group (**5**, **6** and **7**), conceivably allowing for both *synclinal-exo* and *synclinal-endo* conformations to be populated: this is consistent with the recently reported fluorine–NHC gauche effect [22]. The second fluorination site embeds the β -fluoroamine within the bicycle framework of the triazolium salt, thus restricting conformational freedom (e.g. **8**). This later scenario was inspired by the elegant work of Rovis and co-workers, which demonstrated that backbone fluorination of bicyclic NHCs improves enantioselectivity in Stetter reactions of heterocyclic aldehydes with nitroalkenes [37–40]. Finally, one hybrid system was prepared containing both β -fluoroamine classes (**7**). The trifluoromethylated triazolium salt **9** and the non-fluorinated equivalent **10** served as electronic and steric control catalysts for this study.

Results and Discussion

Pre-catalyst synthesis

The synthesis of a novel series of fluorinated triazolium salts (**7–10**) is described, following our previous studies concerning

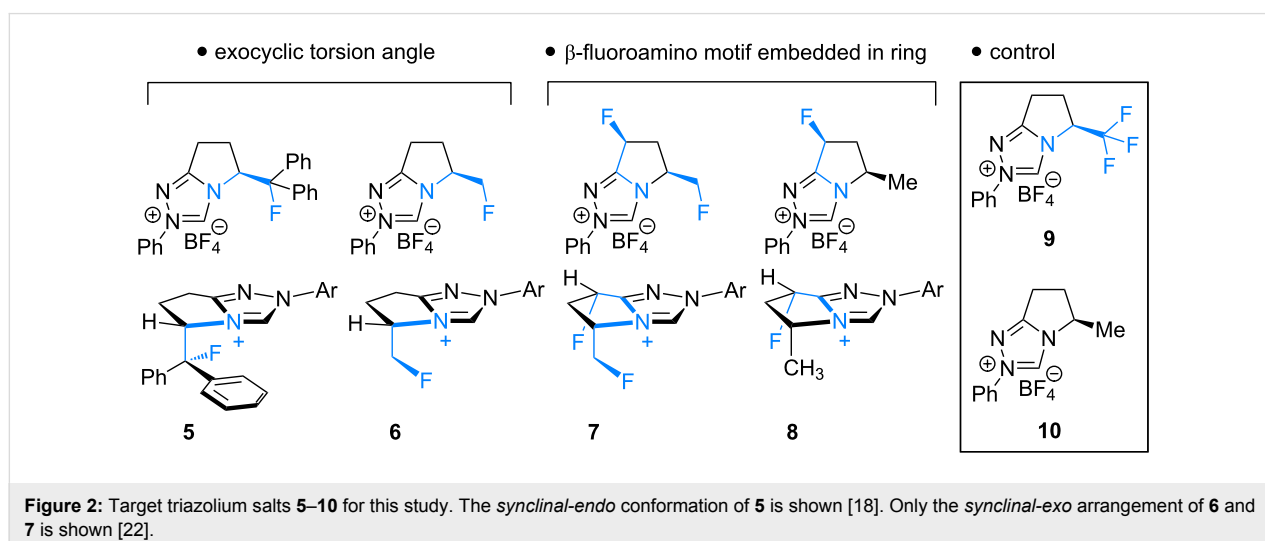
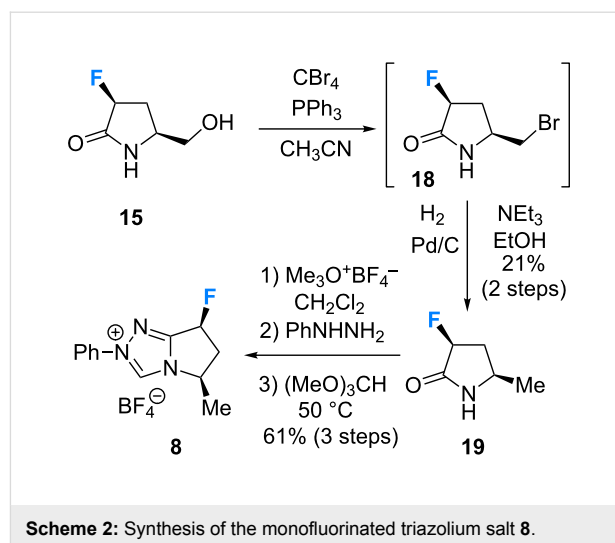

Figure 2: Target triazolium salts **5–10** for this study. The *synclinal-endo* conformation of **5** is shown [18]. Only the *synclinal-exo* arrangement of **6** and **7** is shown [22].

the preparation of triazolium salts **5** and **6** [18,22]. The route to target **7** began by treating *N*-Boc-*trans*-4-hydroxy-L-proline methyl ester (**11**) with diethylaminosulfur trifluoride (DAST) in CH_2Cl_2 to install the first fluoro substituent (**12**) with clean configurational inversion (88%, Scheme 1).

Oxidation of the pyrrolidine to the corresponding lactam **13** using a Ru(III)/ NaIO_4 system proceeded smoothly, followed by TFA-mediated Boc deprotection to yield **14** (75%, 2 steps). Reduction of the methyl ester to the primary alcohol (**15**, 18%), and subsequent protection as the TBDMS ether delivered the cyclisation substrate **16** in good yield (92%). A three step, one pot sequence consisting of methylation, treatment with phenylhydrazine and subsequent cyclisation furnished the triazolium salt **17** in 76% yield (3 steps). Finally, DAST-mediated TBDMS deprotection/deoxyfluorination completed the synthetic sequence to give **7** in 45% yield.

Synthesis of the monofluorinated pre-catalyst **8** (Scheme 2) commenced with an Appel reaction of alcohol **15** to prepare the primary bromide **18**. Owing to the potentially labile nature of the primary bromide, this material was used without further purification in the next step. Reduction (H_2 , Pd/C) furnished the lactam **19** (21% over 2 steps) in preparation for the cyclisation sequence. As previously described, successive treatment with the Meerwein salt, phenylhydrazine and methyl orthoformate yielded the target triazolium salt **8** in 61% over 3 steps.



The pre-catalysts **9** and **10** required for control experiments were prepared by an analogous reaction sequence (Scheme 3). Commercially available (*S*)-(+)-(trifluoromethyl)pyrrolidine **20** was protected (**21**, quantitative), oxidised to the corresponding lactam (**22**, 38% over 2 steps) and processed to the target triazolium salt **9** (46%, 3 steps). The non-fluorinated catalyst **10** (Scheme 3; lower) was prepared in a short synthesis starting from the primary bromide **23** [22]. Hydrogenolysis (**24**, 67%) [41] and subsequent conversion to the triazolium salt completed the short synthesis (52% over 3 steps).

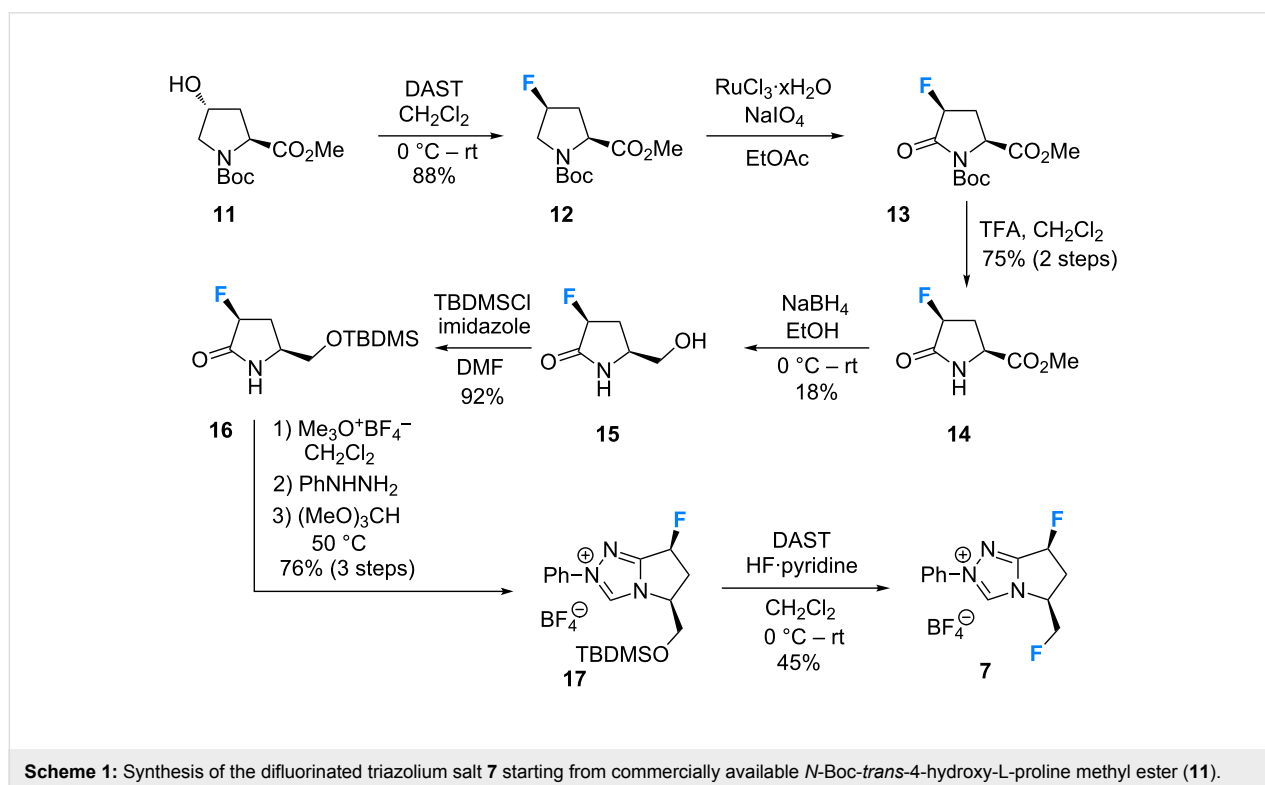

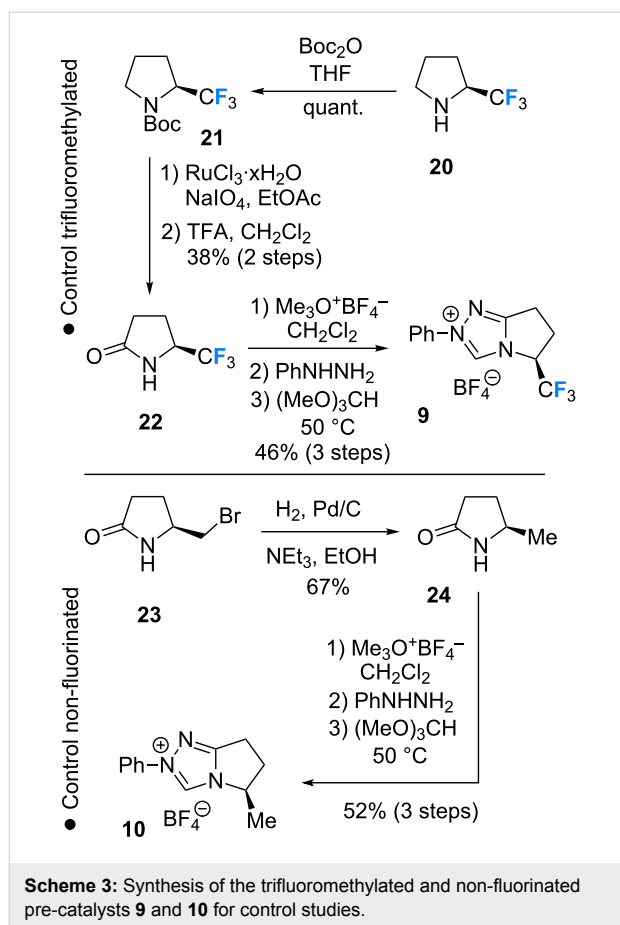

X-Ray structural analysis of **5**, **6** and **7**

The X-ray crystal structures of triazolium salts **5**, **6** and **7** were then compared to examine the conformation of the β -fluoroamine motifs that were the major motivation for this study (Figure 3) [42]. In previous analyses of (*S*)-2-(fluorodiphenylmethyl)pyrrolidine derivatives, the *synclinal-endo* conformation was almost exclusively observed in the solid state [13,15,16,18,21,22]. This was also found to be the case in triazolium salt **5** ($\Phi_{\text{NCCF}} -54.0^\circ$), with the diphenylfluoromethyl group adopting a *quasi*-equatorial orientation, presumably to minimise non-bonding interactions as a consequence of the sterically demanding phenyl groups.

Deletion of these Ph units from the exocyclic group (**6**) resulted in a switch to the *synclinal-exo* conformation ($\Phi_{\text{NCCF}} +67.9^\circ$), with the monofluoromethyl group occupying a *quasi*-axial orientation. Interestingly, this *synclinal-endo* \rightarrow *synclinal-exo* switch is also observed in the corresponding pyrrolidino systems [13,21]. The hybrid structure **7** containing both β -fluoroamine types again showed the *synclinal-exo* arrangement ($\Phi_{\text{NCCF}} +63.65^\circ$) as expected, although the fluorine group on the ring system did little to alter the conformation when compared with **5** and **6**.

Having completed the synthesis of the fluorinated triazolium salts (**5**–**10**) for this study, their effectiveness in catalysing the Steglich rearrangement of an oxazolyl carbonate derivative (**25**)

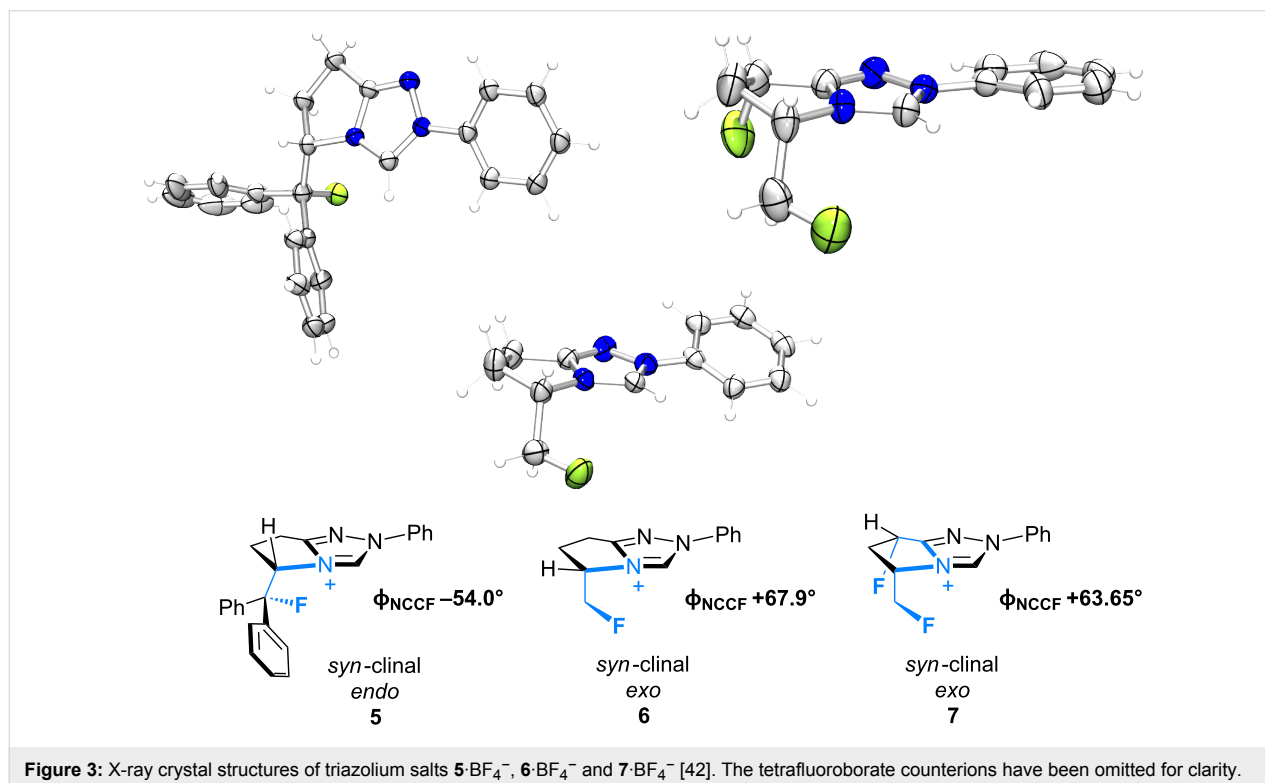

to the corresponding *C*-carboxylactone **26** was investigated (Table 1). For this initial study, the monofluorinated triazolium salt **6** was arbitrarily chosen (10 mol %), with toluene being used as the reaction medium and KHMDS as the base [30]. Gratifyingly, complete conversion was observed after 18 h and with good levels of enantioselectivity (e.r. 80.5:19.5). Variation in the choice of solvent proved detrimental to both the conversion and enantioselectivity (Table 1, entries 2–8). Chlorinated solvents such as CH₂Cl₂ and CDCl₃ (Table 1, entries 2 and 3) led to losses in enantioselectivity, whilst THF completely suppressed the reaction (Table 1, entry 4, <1% conversion). Intriguingly, switching from THF to Et₂O (Table 1, entry 5) resulted in full conversion and gave appreciable enantioselectivity (e.r. 74.0:26.0). This behaviour was also preserved with 1,4-dioxane as solvent (e.r. 74.5:25.5, Table 1, entry 6). Hexane gave comparable levels of enantioinduction but with a marked decrease in conversion (38%, Table 1, entry 7). Employing chlorobenzene did not improve conversion, or the enantiomeric ratio of the products (Table 1, entry 8). Having identified toluene as the solvent of choice, attention was turned to exploring the effect of the base. It was noted that neither DBU (Table 1, entry 9) nor KO^t-Bu (Table 1, entry 10) led to higher levels of enantioselectivity. A control reaction using solid KHMDS, rather than the commercial 0.5 M solution in toluene, revealed a lower conversion but did not alter the enantiomeric ratio (Table 1, entry 11). However, a commensurate performance was noted with Cs₂CO₃ (Table 1, entry 12, >99%, e.r. 80.5:19.5). Alterations in reaction concentration had little influence on the selectivity (Table 1, entries 13 and 14, 0.02 or 0.5 mol·L⁻¹, e.r. 80.5:19.5 and 79.0:21.0, respectively). However, catalyst loading did dramatically alter the selectivity outcome (Table 1, entries 15–17). Given that similar enantioselectivities were recorded in reactions using Cs₂CO₃ (cf. KHMDS), an analogous set of reactions were run for complete-

Employing chlorobenzene did not improve conversion, or the enantiomeric ratio of the products (Table 1, entry 8). Having identified toluene as the solvent of choice, attention was turned to exploring the effect of the base. It was noted that neither DBU (Table 1, entry 9) nor KO^t-Bu (Table 1, entry 10) led to higher levels of enantioselectivity. A control reaction using solid KHMDS, rather than the commercial 0.5 M solution in toluene, revealed a lower conversion but did not alter the enantiomeric ratio (Table 1, entry 11). However, a commensurate performance was noted with Cs₂CO₃ (Table 1, entry 12, >99%, e.r. 80.5:19.5). Alterations in reaction concentration had little influence on the selectivity (Table 1, entries 13 and 14, 0.02 or 0.5 mol·L⁻¹, e.r. 80.5:19.5 and 79.0:21.0, respectively). However, catalyst loading did dramatically alter the selectivity outcome (Table 1, entries 15–17). Given that similar enantioselectivities were recorded in reactions using Cs₂CO₃ (cf. KHMDS), an analogous set of reactions were run for complete-

Table 1: Optimisation studies using triazolium salt **6**.^{a,b}

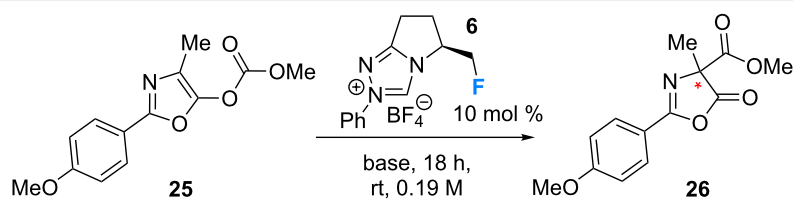

Entry	Solvent	Base	Conc. (mol·L ⁻¹)	Loading (mol %)	T (°C)	Conversion (%) ^b	e.r. ^b
1	toluene	KHMDS	0.19	10	rt	>99	80.5:19.5
2	CH ₂ Cl ₂	KHMDS	0.19	10	rt	89	59.0:41.0
3	CDCl ₃	KHMDS	0.19	10	rt	39	70.0:30.0
4	THF	KHMDS	0.19	10	rt	<1	—
5	Et ₂ O	KHMDS	0.19	10	rt	>99	74.0:26.0
6	1,4-dioxane	KHMDS	0.19	10	rt	95	74.5:25.5
7	<i>n</i> -hexane	KHMDS	0.19	10	rt	38	79.0:21.0
8	PhCl	KHMDS	0.19	10	rt	65	71.5:28.5
9	toluene	DBU	0.19	10	rt	67	79.5:20.5
10	toluene	KO ^t -Bu	0.19	10	rt	14	78.5:21.5
11	toluene	KHMDS (solid)	0.19	10	rt	66	79.0:21.0
12	toluene	Cs ₂ CO ₃	0.19	10	rt	>99	80.5:19.5
13	toluene	KHMDS	0.02	10	rt	97	80.5:19.5
14	toluene	KHMDS	0.50	10	rt	>99	79.0:21.0
15	toluene	KHMDS	0.19	30	rt	>99	66.5:33.5
16	toluene	KHMDS	0.19	5	rt	63	80.5:19.5
17	toluene	KHMDS	0.19	1	rt	<1	—
18	toluene	Cs ₂ CO ₃	0.02	10	rt	92	81.0:19.0
19	toluene	Cs ₂ CO ₃	0.50	10	rt	99	80.0:20.0
20	toluene	Cs ₂ CO ₃	0.19	30	rt	99	80.0:20.0
21	toluene	Cs ₂ CO ₃	0.19	5	rt	96	80.0:20.0

^aRepresentative reaction protocol: To a suspension of **6** in the appropriate solvent was added the base indicated. The mixture was then stirred for 15 min before a solution of **25** (20.0 mg, 76.0 μmol) in toluene was added. The mixture was stirred for a further 18 h, after which time the solution was concentrated in vacuo and filtered over a plug of silica gel (CH₂Cl₂ as eluent). The resulting solution was then concentrated in vacuo. ^bThe conversion and enantiomeric ratio of the product were determined by HPLC on an Agilent 1260 series system using a reprosil chiral-OM 4.6 mm column. Percent conversion was determined by integration of the starting material and product peaks, correcting for response factors.

ness (Table 1, entries 18–21). Again, reactions using Cs_2CO_3 were not sensitive to changes in concentration (Table 1, entries 18 and 19), but in contrast to reactions employing KHMDS, altering the catalyst loading did not result in an erosion of the enantioselectivity (Table 1, entries 20 and 21, e.r. 80.0:20.0).

Having evaluated a series of parameters for the catalytic Steglich rearrangement using catalyst **6**, efforts were then focussed on a logical process of molecular editing to clarify the effect of H→F substitution (Table 2). Once again, toluene was employed as solvent, and reactions were run at rt for 18 h at a

Table 2: A catalyst molecular editing study.^{a,b}

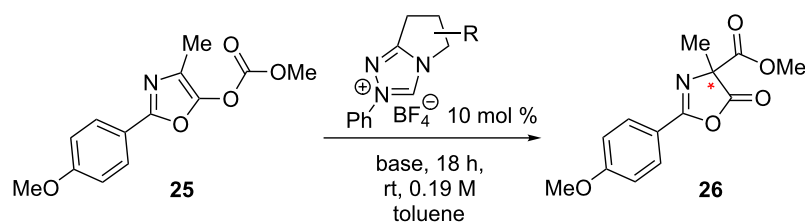

Entry	Catalyst	Base	Conversion (%) ^b	e.r. ^b
1	 5	Cs_2CO_3	83	54.5:45.5 ^c
2		KHMDS	0	n.d.
3	 6	Cs_2CO_3	99	80.5:19.5
4		KHMDS	99	80.5:19.5
5	 7	Cs_2CO_3	99	87.0:13.0
6		KHMDS	14	86.0:14.0
7	 8	Cs_2CO_3	97	77.5:22.5
8		KHMDS	54	76.0:24.0
9	 9	Cs_2CO_3	0	n.d.
10		KHMDS	0	n.d.
11	 10	Cs_2CO_3	98	62.5:37.5
12		KHMDS	81	62.5:37.5

^aRepresentative reaction protocol: A suspension of the catalyst (7.6 μmol) in toluene (200 μL) was treated with Cs_2CO_3 (2.5 mg, 7.6 μmol) and stirred for 15 min. A solution of **25** (20.0 mg, 76.0 μmol) in toluene (200 μL) was then added. The mixture was stirred for a further 18 h, after which time the solution was concentrated in vacuo and filtered over a plug of silica gel (CH_2Cl_2 as eluent). The resulting solution was then concentrated in vacuo.

^bThe conversion and enantiomeric ratio of the product were determined by HPLC on an Agilent 1260 series system using a reprosil chiral-OM 4.6 mm column. Percent conversion was determined by integration of the starting material and product peaks, correcting for response factors. ^cReversal in the sense of enantioselectivity.

concentration of 0.19 M. Due to the similar enantioselectivities observed when using KHMDS and Cs₂CO₃ (Table 1), it was deemed prudent to perform the study using both bases independently. Initially, the bulky diphenylfluoromethyl-containing triazolium salt **5** was subjected to the optimised conditions. It was envisaged that one of the phenyl rings might assist in the facial discrimination of the activated electrophile, as a consequence of the fluorine gauche effect ($\Phi_{\text{NCCF}} -54.0^\circ$, Figure 3). However, the product *C*-carboxylactone **26** was isolated essentially in racemic form (Table 2, entry 1, e.r. 54.5:45.5). Despite the modest selectivity, the sense of induction was inverted relative to what had been previously observed. Puzzlingly, reactions in the presence of KHMDS did not yield any of the desired product (Table 2, entry 2). As previously established, deletion of the phenyl rings resulted in a marked improvement with both the conversion and enantioselectivity reaching useful values (99%, e.r. 80.5:19.5, Table 2, entries 3 and 4). As had been reported by Rovis et al. for certain Stetter reactions [37–40], fluorination of the bicycle framework (**7**) augmented the catalyst performance (Table 2, entries 5 and 6). In the presence of Cs₂CO₃ almost quantitative conversion was noted together with the highest enantioselectivities of the study (up to e.r. 87.0:13.0). Again, a significant loss in conversion was observed in reactions performed with KHMDS (Table 2, entry 6, 14%). Deletion of the fluorine substituent on the exocyclic group (**8**) resulted in a notable drop in the enantiomeric ratio (77.5:22.5, Table 2, entry 7), with reactions containing KHMDS reaching only 54% conversion. Finally, in the control reaction with the trifluoromethyl-containing triazolium salt **9**, no conversion was observed irrespective of the base employed (Table 2, entries 9 and 10). Deletion of both fluorine atoms from the catalyst core (**10**) was accompanied by a drop in enantioselectivity (e.r. 62.5:37.5), although the reactions did not display the same sensitivity to changes in base (Table 2, entries 11 and 12).

Conclusion

In conclusion, the ability of fluorine to modulate the catalytic performance of *N*-heterocyclic carbenes in the Steglich rearrangement of oxazolyl carbonates has been demonstrated. A focussed molecular editing study (Figure 4) has revealed that the introduction of a single fluorine atom on the exocyclic unit leads to enhanced enantioselectivities (**6** versus **10**, e.r. 80.5:19.5 versus 62.5:37.5). Further augmentation can be achieved by introduction of a second fluorine substituent on the catalyst core (**7**; e.r. 87.0:13.0, 99% conversion). However, the reinforcing role of these two fluorine substituents in orchestrating enantioinduction requires clarification and will be the subject of future investigations. What is apparent is that fluorine incorporation can confer significant advantages in (organo)catalyst optimisation and design.

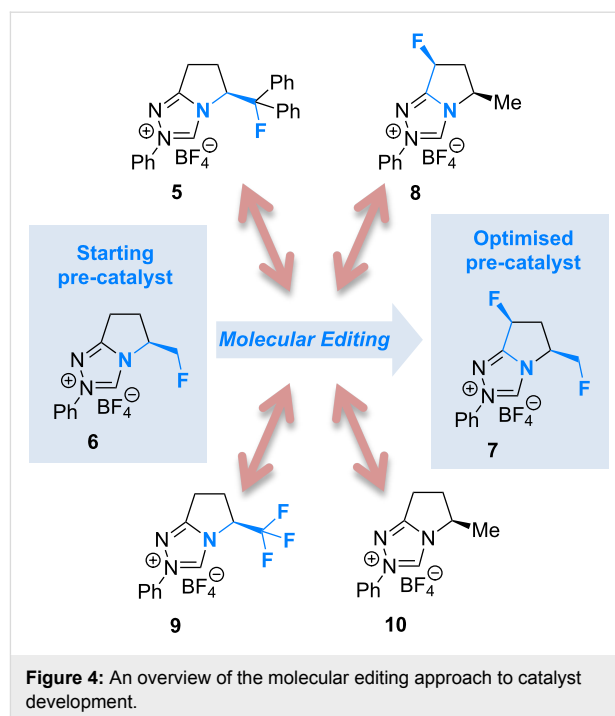

Experimental

Full experimental data is provided in Supporting Information File 1.

Supporting Information

Supporting Information File 1

Experimental part.

[<http://www.beilstein-journals.org/bjoc/content/supplementary/1860-5397-9-316-S1.pdf>]

Acknowledgements

We gratefully acknowledge generous financial support from the WWU Münster, and the ETH Zürich (Independent Investigator Research Award to R.G.). This work was partly supported by the Deutsche Forschungsgemeinschaft, DFG EXC 1003 “Cells in Motion – Cluster of Excellence, Münster”, Germany. We thank Dr. S. Paul for performing preliminary catalysis experiments (ETH Zürich dissertation 20370), Dr. E.-M. Tanzer for preparing compound **25** (ETH dissertation number 20919), and Dr. C. Daniliuc for determining the X-ray structure of triazolium salt **7**.

References

- Zimmer, L. E.; Sparr, C.; Gilmour, R. *Angew. Chem.* **2011**, *123*, 12062–12074. doi:10.1002/ange.201102027
Angew. Chem., Int. Ed. **2011**, *50*, 11860–11871. doi:10.1002/anie.201102027

2. Sparr, C.; Zimmer, L. E.; Gilmour, R. In *Asymmetric Syntheses. More Methods and Applications*; Bräse, S.; Christmann, M., Eds.; Wiley-VCH Verlag GmbH & Co: Weinheim, 2011; pp 117–124.
3. Holland, M. C.; Paul, S.; Schweizer, W. B.; Bergander, K.; Mück-Lichtenfeld, C.; Lakhdar, S.; Mayr, H.; Gilmour, R. *Angew. Chem.* **2013**, *125*, 8125–8129. doi:10.1002/ange.201301864
Angew. Chem., Int. Ed. **2013**, *52*, 7967–7971. doi:10.1002/anie.201301864
4. O'Hagan, D. *Chem. Soc. Rev.* **2008**, *37*, 308–319. doi:10.1039/b711844a
5. Irwin, J. J.; Ha, T.-K.; Dunitz, J. D. *Helv. Chim. Acta* **1990**, *73*, 1805–1817. doi:10.1002/hlca.19900730702
6. Wolfe, S. *Acc. Chem. Res.* **1972**, *5*, 102–111. doi:10.1021/ar50051a003
7. Huber-Wälchli, P.; Günthard, H. H. *Spectrochim. Acta, Part A* **1981**, *37*, 285–304. doi:10.1016/0584-8539(81)80159-6
8. Durig, J. R.; Liu, J.; Little, T. S.; Kalasinsky, V. F. *J. Phys. Chem.* **1992**, *96*, 8224–8233. doi:10.1021/j100200a006
9. Craig, N. C.; Chen, A.; Suh, K. H.; Klee, S.; Mellau, G. C.; Winnewisser, B. P.; Winnewisser, M. *J. Am. Chem. Soc.* **1997**, *119*, 4789–4790. doi:10.1021/ja963819e
10. O'Hagan, D.; Bilton, C.; Howard, J. A. K.; Knight, L.; Tozer, D. J. *J. Chem. Soc., Perkin Trans. 2* **2000**, 605–607. doi:10.1039/B000205O
11. Briggs, C. R. S.; O'Hagan, D.; Howard, J. A. K.; Yufit, D. S. *J. Fluorine Chem.* **2003**, *119*, 9–13. doi:10.1016/S0022-1139(02)00243-9
12. Briggs, C. R. S.; Allen, M. J.; O'Hagan, D.; Tozer, D. J.; Slawin, A. M. Z.; Goeta, A. E.; Howard, J. A. K. *Org. Biomol. Chem.* **2004**, *2*, 732–740. doi:10.1039/b312188g
13. Sparr, C.; Schweizer, W. B.; Senn, H. M.; Gilmour, R. *Angew. Chem.* **2009**, *121*, 3111–3114. doi:10.1002/ange.200900405
Angew. Chem., Int. Ed. **2009**, *48*, 3065–3068. doi:10.1002/anie.200900405
14. Bucher, C.; Sparr, C.; Schweizer, W. B.; Gilmour, R. *Chem.–Eur. J.* **2009**, *15*, 7637–7647. doi:10.1002/chem.200900505
15. Sparr, C.; Tanzer, E.-M.; Bachmann, J.; Gilmour, R. *Synthesis* **2010**, 1394–1397. doi:10.1055/s-0029-1218636
16. Seebach, D.; Gilmour, R.; Großel, U.; Deniau, G.; Sparr, C.; Ebert, M.-O.; Beck, A. K.; McCusker, L. B.; Šišak, D.; Uchimaru, T. *Helv. Chim. Acta* **2010**, *93*, 603–634. doi:10.1002/hlca.201000069
17. Sparr, C.; Gilmour, R. *Angew. Chem.* **2010**, *122*, 6670–6673. doi:10.1002/ange.201003734
Angew. Chem., Int. Ed. **2010**, *49*, 6520–6523. doi:10.1002/anie.201003734
18. Paul, S.; Schweizer, W. B.; Ebert, M.-O.; Gilmour, R. *Organometallics* **2010**, *29*, 4424–4427. doi:10.1021/om100789n
19. Sparr, C.; Salamanova, E.; Schweizer, W. B.; Senn, H. M.; Gilmour, R. *Chem.–Eur. J.* **2011**, *17*, 8850–8857. doi:10.1002/chem.201100644
20. Tanzer, E.-M.; Schweizer, W. B.; Ebert, M.-O.; Gilmour, R. *Chem.–Eur. J.* **2012**, *18*, 2006–2013. doi:10.1002/chem.201102859
21. Tanzer, E.-M.; Zimmer, L. E.; Schweizer, W. B.; Gilmour, R. *Chem.–Eur. J.* **2012**, *18*, 11334–11342. doi:10.1002/chem.201201316
22. Paul, S.; Schweizer, W. B.; Rugg, G.; Senn, H. M.; Gilmour, R. *Tetrahedron* **2013**, *69*, 5647–5659. doi:10.1016/j.tet.2013.02.071
23. Enders, D.; Balensiefer, T. *Acc. Chem. Res.* **2004**, *37*, 534–541. doi:10.1021/ar030050j
24. Johnson, J. S. *Angew. Chem., Int. Ed.* **2004**, *43*, 1326–1328. doi:10.1002/anie.200301702
25. Enders, D.; Niemeier, O.; Henseler, A. *Chem. Rev.* **2007**, *107*, 5606–5655. doi:10.1021/cr068372z
26. Dröge, T.; Glorius, F. *Angew. Chem., Int. Ed.* **2010**, *49*, 6940–6952. doi:10.1002/anie.201001865
27. Ryan, S. J.; Candish, L.; Lupton, D. W. *Chem. Soc. Rev.* **2013**, *42*, 4906–4917. doi:10.1039/c3cs35522e
28. Nelson, D. J.; Nolan, S. P. *Chem. Soc. Rev.* **2013**, *42*, 6723–6753. doi:10.1039/c3cs60146c
29. Steglich, W.; Höfle, G. *Tetrahedron Lett.* **1970**, *11*, 4727–4730. doi:10.1016/S0040-4039(00)89379-X
30. Thomson, J. E.; Rix, K.; Smith, A. D. *Org. Lett.* **2006**, *8*, 3785–3788. doi:10.1021/ol061380h
31. Thomson, J. E.; Campbell, C. D.; Concellón, C.; Duguet, N.; Rix, K.; Slawin, A. M. Z.; Smith, A. D. *J. Org. Chem.* **2008**, *73*, 2784–2791. doi:10.1021/jo702720a
32. Campbell, C. D.; Duguet, N.; Gallagher, K. A.; Thomson, J. E.; Lindsay, A. G.; O'Donoghue, A. C.; Smith, A. D. *Chem. Commun.* **2008**, 3528–3530. doi:10.1039/b806816j
33. Thomson, J. E.; Kyle, A. F.; Gallagher, K. A.; Lenden, P.; Concellón, C.; Morrill, L. C.; Miller, A. J.; Joannes, C.; Slawin, A. M. Z.; Smith, A. D. *Synthesis* **2008**, 2805–2818. doi:10.1055/s-2008-1077890
34. Thomson, J. E.; Kyle, A. F.; Ling, K. B.; Smith, S. R.; Slawin, A. M. Z.; Smith, A. D. *Tetrahedron* **2010**, *66*, 3801–3813. doi:10.1016/j.tet.2010.03.047
35. Campbell, C. D.; Collett, C. J.; Thomson, J. E.; Slawin, A. M. Z.; Smith, A. D. *Org. Biomol. Chem.* **2011**, *9*, 4205–4218. doi:10.1039/c1ob05160a
36. Campbell, C. D.; Concellón, C.; Smith, A. D. *Tetrahedron: Asymmetry* **2011**, *22*, 797–811. doi:10.1016/j.tetasy.2011.04.001
37. DiRocco, D. A.; Oberg, K. M.; Dalton, D. M.; Rovis, T. *J. Am. Chem. Soc.* **2009**, *131*, 10872–10874. doi:10.1021/ja904375q
38. Sánchez-Larios, E.; Thai, K.; Bilodeau, F.; Gravel, M. *Org. Lett.* **2011**, *13*, 4942–4945. doi:10.1021/ol202040b
39. Um, J. M.; DiRocco, D. A.; Noey, E. L.; Rovis, T.; Houk, K. N. *J. Am. Chem. Soc.* **2011**, *133*, 11249–11254. doi:10.1021/ja202444g
40. DiRocco, D. A.; Noey, E. L.; Houk, K. N.; Rovis, T. *Angew. Chem., Int. Ed.* **2012**, *51*, 2391–2394. doi:10.1002/anie.201107597
41. McIntosh, J. M.; Acquaah, S. O. *Can. J. Chem.* **1988**, *66*, 1752–1756. doi:10.1139/v88-282
42. CCDC 782696, 919179 and 969412 contain the supplementary crystallographic data for **5** [18], **6** [22] and **7**, respectively. These data can be obtained free of charge from the Cambridge Crystallographic Data Centre via http://www.ccdc.cam.ac.uk/data_request/cif.

License and Terms

This is an Open Access article under the terms of the Creative Commons Attribution License (<http://creativecommons.org/licenses/by/2.0>), which permits unrestricted use, distribution, and reproduction in any medium, provided the original work is properly cited.

The license is subject to the *Beilstein Journal of Organic Chemistry* terms and conditions: (<http://www.beilstein-journals.org/bjoc>)

The definitive version of this article is the electronic one which can be found at:
[doi:10.3762/bjoc.9.316](https://doi.org/10.3762/bjoc.9.316)

Cu-Mediated trifluoromethylation of benzyl, allyl and propargyl methanesulfonates with TMSCF_3

Xueliang Jiang¹ and Feng-Ling Qing^{*1,2}

Full Research Paper

Open Access

Address:

¹Key Laboratory of Organofluorine Chemistry, Shanghai Institute of Organic Chemistry, Chinese Academy of Sciences, 345 Lingling Lu, Shanghai 200032, China and ²College of Chemistry, Chemical Engineering and Biotechnology, Donghua University, 2999 North Renmin Lu, Shanghai 201620, China

Email:

Feng-Ling Qing* - flq@mail.sioc.ac.cn

* Corresponding author

Keywords:

copper; methanesulfonates; organo-fluorine; trifluoromethylation

Beilstein J. Org. Chem. **2013**, *9*, 2862–2865.

doi:10.3762/bjoc.9.322

Received: 18 September 2013

Accepted: 25 October 2013

Published: 12 December 2013

This article is part of the Thematic Series "Organo-fluorine chemistry III".

Guest Editor: D. O'Hagan

© 2013 Jiang and Qing; licensee Beilstein-Institut.

License and terms: see end of document.

Abstract

A Cu-mediated trifluoromethylation of benzyl, allyl and propargyl methanesulfonates with TMSCF_3 was developed for the first time. This method offers a convenient and economical approach to various trifluoroethyl-containing compounds.

Introduction

Fluorinated organic molecules are extremely important in agrochemicals, pharmaceuticals and materials [1-6]. In recent years, (trifluoroethyl)arenes have drawn increasing attention in medicinal chemistry and related fields [7-9]. Different methods have been developed for the synthesis of (trifluoroethyl)arenes, such as Cl-F exchange of the trichloroethyl derivatives [10], reduction of the (trifluoroethyl)aryl derivatives [11] and addition of 2,2-difluorostyrene derivatives [12]. Compared to these methods, the direct transition metal-mediated trifluoroethylation of arylboronic acids [13,14] (Scheme 1a) and trifluoromethylation of benzyl halides [15-21] (Scheme 1b) are more convenient. Especially trifluoromethylations of benzyl bromides with a $[\text{CuCF}_3]$ species, which are generated from different precursors, are generally employed to afford various

(trifluoroethyl)arenes. Although these methods are proven efficient, it is still highly desirable to develop new protocols from economic consideration. In continuation of our research on transition metal-mediated trifluoromethylation [22-27], we report here the first example of Cu-mediated trifluoromethylation of benzyl methanesulfonates (Scheme 1c).

Results and Discussion

We initiated our investigation by reacting benzyl methanesulfonate **1a** with TMSCF_3 (2.0 equiv) in the presence of KF (2.0 equiv) and CuI (0.2 equiv) in DMF (2.0 mL) at 60 °C under Ar atmosphere. However, only 17% yield of the desired product **2a** was observed in this case (Table 1, entry 1). The yield was improved to 31% when the reaction was carried out in

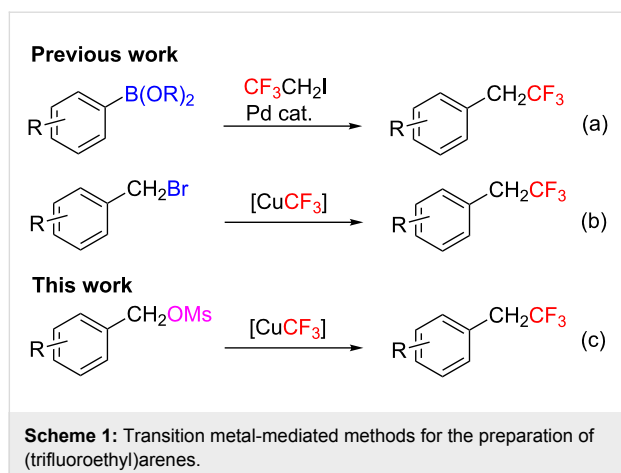

the presence of 1,10-phenanthroline (phen) (Table 1, entry 2). Increasing the substrate concentration (from 0.1 M to 0.4 M) could further improve the product yield to 49% (Table 1, entries 3 and 4). Other copper salts such as CuBr, CuCl, CuTc and CuOAc, were next screened, but none of them was better than CuI (Table 1, entries 5–8). Interestingly, when the benzyl methanesulfonate reacted with [CuCF₃] generated in situ from TMSCF₃ and a stoichiometric amount of CuI (1.1 equiv) without phen, the desired product **2a** was formed in 68% yield (Table 1, entry 9). Decreasing or increasing the amount of CuI resulted in a lower yield (Table 1, entries 10 and 11). The solvent was next screened and, to our delight, the highest yield

of the product was achieved when using DMF/HMPA (1:1) as the mixed solvent (Table 1, entry 14).

With the optimal conditions in hand, we next examined the substrate scope of the Cu-mediated trifluoromethylation of benzyl methanesulfonates with TMSCF₃ (Scheme 2). This method tolerates various functional groups. A wide range of benzyl methanesulfonates bearing electron-withdrawing groups, such as nitro (**1f**), cyano (**1g**), trifluoromethyl (**1h**) and ester (**1i**), as well as electron-donating groups such as phenyl (**1b**), smoothly underwent the transformation, affording the desired products in moderate to good yield. Importantly, both chloro (**1d**) and bromo (**1e**) substituents are also compatible with this method. It is particularly noteworthy that the reaction can be scaled up efficiently. **2a** and **2c** were successfully prepared on 10 mmol scale, indicating the good reliability of the process.

The present reaction could also be expanded to the trifluoromethylation of allylic methanesulfonates (Scheme 3). Treatment of the substrate **1k** under the standard reaction conditions afforded the linear trifluoromethylated product **2k** in 78% yield with a trace amount of Z isomer. Interesting, the reactions with the allylic methanesulfonates **1l** and **1m** gave the same regioselectivity and stereoselectivity with good yields. These observations indicate that a π -allyl/Cu^{III} complex might be involved in the C_{sp3}-CF₃ bond formation, but the detailed mechanism remains to be elucidated.

Table 1: Optimization of the reaction conditions.^a

entry	CuX (equiv)	ligand	solvent	yield of 2a (%) ^b
1 ^c	CuI (0.2)	–	DMF	17
2 ^c	CuI (0.2)	phen	DMF	31
3 ^d	CuI (0.2)	phen	DMF	32
4	CuI (0.2)	phen	DMF	49
5	CuBr (0.2)	phen	DMF	40
6	CuCl (0.2)	phen	DMF	trace
7 ^e	CuTc (0.2)	phen	DMF	trace
8	CuOAc	phen	DMF	trace
9	CuI (1.1)	–	DMF	68
10	CuI (1.5)	–	DMF	66
11	CuI (1.0)	–	DMF	62
12	CuI (1.1)	–	DMSO	38
13	CuI (1.1)	–	HMPA	9
14	CuI (1.1)	–	DMF/HMPA (1:1)	76

^aReaction conditions: **1a** (0.2 mmol), ligand (0.2 mmol), TMSCF₃ (0.4 mmol), KF (0.4 mmol), DMF (0.5 mL), 60 °C, under Ar atmosphere. ^bYield was determined by ¹⁹F NMR using benzo-trifluoride as an internal standard. ^c2.0 mL of DMF. ^d1.0 mL of DMF. ^eCuTc is copper(I) thiophene-2-carboxylate.

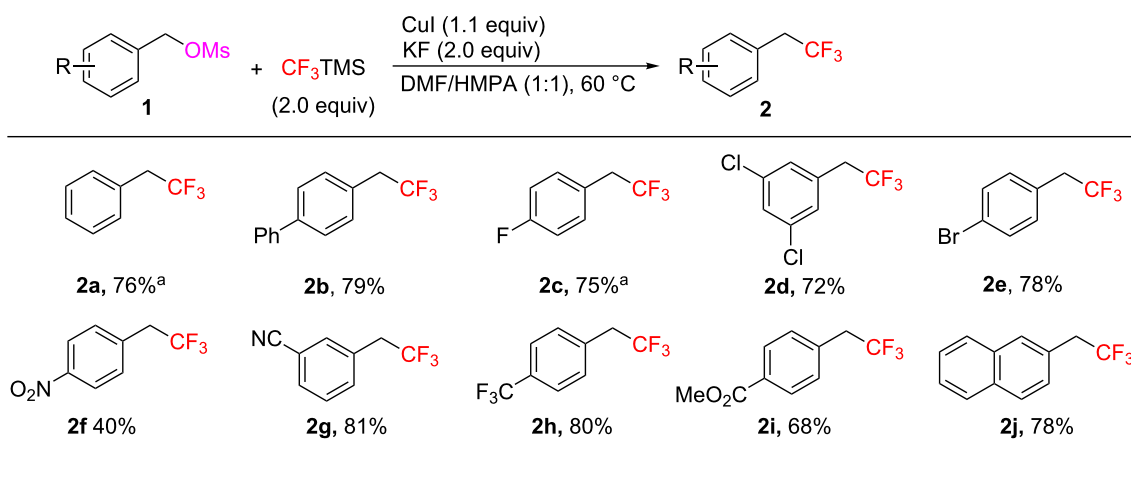

Scheme 2: Cu-mediated trifluoromethylation of benzyl methanesulfonates. Reaction conditions: **1** (2.0 mmol), CuI (2.2 mmol), TMSCF₃ (4.0 mmol), KF (4.0 mmol), DMF/HMPA (1:1, 5.0 mL), 60 °C, under Ar atmosphere; Isolated yield. ^aIsolated yield after distillation on 10.0 mmol scale.

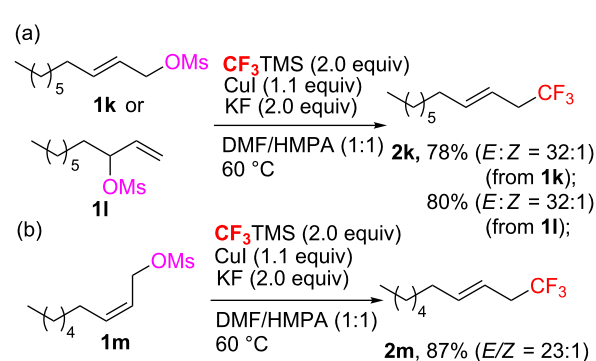

Scheme 3: Cu-Mediated trifluoromethylation of allyl methanesulfonates.

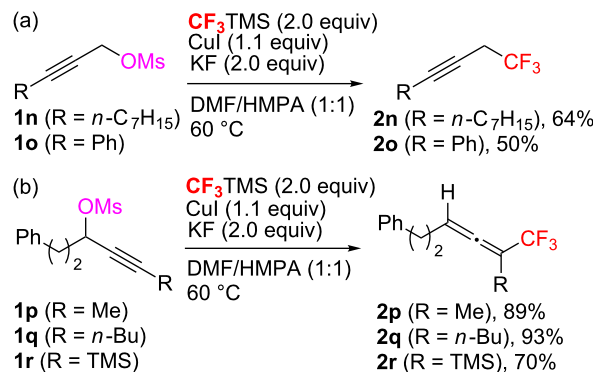

Scheme 4: Cu-Mediated trifluoromethylation of propargyl methanesulfonates.

We were next interested in the trifluoromethylation of propargyl methanesulfonate derivatives. Both aliphatic and aryl-substituted linear propargyl methanesulfonates under standard reaction conditions afforded the corresponding trifluoromethylated propargylic products in moderate yields (Scheme 4a). However, the reaction of the branched substrates under identical conditions gave the trifluoromethylated allenyl products in good to excellent yields, without any trifluoromethylated propargylic products (Scheme 4b). Thus, this reaction provides an efficient protocol for the synthesis of allenyl-CF₃ derivatives, which are useful building blocks for pharmaceuticals [28,29].

Conclusion

In summary, we have developed an efficient copper-mediated trifluoromethylation of benzyl methanesulfonates at the benzylic position under mild conditions. The reaction can be

easily scaled up and allows for the efficient synthesis of a series of (trifluoroethyl)arenes with excellent functional group compatibility. Furthermore, the method could also be extended to the trifluoromethylation of allyl and propargyl methanesulfonates, affording the corresponding allylic-, propargylic- and allenyl-CF₃ derivatives.

Experimental

General procedure for the Cu-mediated trifluoromethylation of benzyl methanesulfonates: CuI (2.2 mmol) and KF (4.0 mmol) were added into a Schlenk tube equipped with a magnetic stirring bar under Ar atmosphere. DMF (5.0 mL) and Me₃SiCF₃ (2.0 equiv) were added. After stirring for 20 minutes, the mixture was heated to 60 °C and then benzyl methanesulfonate (2.0 mmol) was added under N₂ atmosphere. The reaction mixture was kept at 60 °C for 4 hours and then cooled to

room temperature. The resulting mixture was diluted with diethyl ether, washed with water and brine, dried over sodium sulfate, and concentrated. The crude products were purified by column chromatography on silica gel to give the products.

Supporting Information

Supporting Information File 1

Experimental details, characterization data of all products and copies of NMR spectra.

[<http://www.beilstein-journals.org/bjoc/content/supplementary/1860-5397-9-322-S1.pdf>]

Acknowledgements

We gratefully acknowledge National Natural Science Foundation of China (21072028, 21272036) and National Basic Research Program of China (2012CB21600).

References

- Kirsch, P. *Modern Fluoroorganic Chemistry*; Wiley-VCH: Weinheim, 2004. doi:10.1002/352760393X
- Uneyama, K. *Organofluorine Chemistry*; Blackwell: Oxford, U.K., 2006. doi:10.1002/9780470988589
- Ojima, I. *Fluorine in Medicinal Chemistry and Chemical Biology*; Wiley-Blackwell: Chichester, U.K., 2009.
- Müller, K.; Faeh, C.; Diederich, F. *Science* **2007**, *317*, 1881–1886. doi:10.1126/science.1131943
- Kirk, K. L. *Org. Process Res. Dev.* **2008**, *12*, 305–321. doi:10.1021/op700134j
- O'Hagan, D. *Chem. Soc. Rev.* **2008**, *37*, 308–319. doi:10.1039/b711844a
- Shi, G. Q.; Dropinski, J. F.; Zhang, Y.; Santini, C.; Sahoo, S. P.; Berger, J. P.; MacNaul, K. L.; Zhou, G.; Agrawal, A.; Alvaro, R.; Cai, T.-Q.; Hernandez, M.; Wright, S. D.; Moller, D. E.; Heck, J. V.; Meinke, P. T. *J. Med. Chem.* **2005**, *48*, 5589–5599. doi:10.1021/jm050373g
- Parrish, C. A.; Adams, N. D.; Auger, K. R.; Burgess, J. L.; Carson, J. D.; Chaudhari, A. M.; Copeland, R. A.; Diamond, M. A.; Donatelli, C. A.; Duffy, K. J.; Faucette, L. F.; Finer, J. T.; Huffman, W. F.; Hugger, E. D.; Jackson, J. R.; Knight, S. D.; Luo, L.; Moore, M. L.; Newlander, K. A.; Ridgers, L. H.; Sakowicz, R.; Shaw, A. N.; Sung, C.-M. M.; Sutton, D.; Wood, K. W.; Zhang, S.-Y.; Zimmerman, M. N.; Dhanak, D. *J. Med. Chem.* **2007**, *50*, 4939–4952. doi:10.1021/jm070435y
- Macsari, I.; Besidski, Y.; Csajnyik, G.; Nilsson, L. I.; Sandberg, L.; Yngve, U.; Ahlin, K.; Bueters, T.; Eriksson, A. B.; Lund, P.-E.; Venyike, E.; Oerther, S.; Hygge Blakeman, K.; Luo, L.; Arvidsson, P. I. *J. Med. Chem.* **2012**, *55*, 6866–6880. doi:10.1021/jm300623u
- Ando, A.; Miki, T.; Kumadaki, I. *J. Org. Chem.* **1988**, *53*, 3637–3639. doi:10.1021/jo00250a049
- Uneyama, K.; Momota, M.; Hayashida, K.; Itoh, T. *J. Org. Chem.* **1990**, *55*, 5364–5368. doi:10.1021/jo00306a013
- Nguyen, B. V.; Burton, D. J. *J. Org. Chem.* **1997**, *62*, 7758–7764. doi:10.1021/jo971019w
- Zhao, Y.; Hu, J. *Angew. Chem., Int. Ed.* **2012**, *51*, 1033–1036. doi:10.1002/anie.201106742
- Liang, A.; Li, X.; Liu, D.; Li, J.; Zou, D.; Wu, Y.; Wu, Y. *Chem. Commun.* **2012**, *48*, 8273–8275. doi:10.1039/c2cc31651j
- Kobayashi, Y.; Yamamoto, K.; Kumadaki, I. *Tetrahedron Lett.* **1979**, *20*, 4071–4072. doi:10.1016/S0040-4039(01)86506-0
- Urata, H.; Fuchikami, T. *Tetrahedron Lett.* **1991**, *32*, 91–94. doi:10.1016/S0040-4039(00)71226-3
- Chen, Q.-Y.; Duan, J.-X. *J. Chem. Soc., Chem. Commun.* **1993**, 1389–1391. doi:10.1039/C39930001389
- Kim, J.; Shreeve, J. M. *Org. Biomol. Chem.* **2004**, *2*, 2728–2734. doi:10.1039/b412480b
- Dubinina, G. G.; Furutachi, H.; Vivic, D. A. *J. Am. Chem. Soc.* **2008**, *130*, 8600–8601. doi:10.1021/ja802946s
- Dubinina, G. G.; Ogikubo, J.; Vivic, D. A. *Organometallics* **2008**, *27*, 6233–6235. doi:10.1021/om800794m
- Kawai, H.; Furukawa, T.; Nomura, Y.; Tokunaga, E.; Shibata, N. *Org. Lett.* **2011**, *13*, 3596–3599. doi:10.1021/ol201205t
- Chu, L.; Qing, F.-L. *J. Am. Chem. Soc.* **2010**, *132*, 7262–7263. doi:10.1021/ja102175w
- Chu, L.; Qing, F.-L. *Org. Lett.* **2010**, *12*, 5060–5063. doi:10.1021/ol1023135
- Chu, L.; Qing, F.-L. *J. Am. Chem. Soc.* **2012**, *134*, 1298–1304. doi:10.1021/ja209992w
- Jiang, X.; Chu, L.; Qing, F.-L. *J. Org. Chem.* **2012**, *77*, 1251–1257. doi:10.1021/jo202566h
- Chu, L.; Qing, F.-L. *Org. Lett.* **2012**, *14*, 2106–2109. doi:10.1021/ol300639a
- Wu, X.; Chu, L.; Qing, F.-L. *Angew. Chem., Int. Ed.* **2013**, *52*, 2198–2202. doi:10.1002/anie.201208971
- Zhao, T. S. N.; Szabó, K. J. *Org. Lett.* **2012**, *14*, 3966–3969. doi:10.1021/ol3017287
- Miyake, Y.; Ota, S.; Shibata, M.; Nakajima, K.; Nishibayashi, Y. *Chem. Commun.* **2013**, *49*, 7809–7811. doi:10.1039/c3cc44434a

License and Terms

This is an Open Access article under the terms of the Creative Commons Attribution License (<http://creativecommons.org/licenses/by/2.0>), which permits unrestricted use, distribution, and reproduction in any medium, provided the original work is properly cited.

The license is subject to the *Beilstein Journal of Organic Chemistry* terms and conditions: (<http://www.beilstein-journals.org/bjoc>)

The definitive version of this article is the electronic one which can be found at: [doi:10.3762/bjoc.9.322](http://dx.doi.org/10.3762/bjoc.9.322)

Synthesis, characterization and initial evaluation of 5-nitro-1-(trifluoromethyl)-3*H*- 1λ³,2-benziodaoxol-3-one

Nico Santschi, Roman C. Sarott, Elisabeth Otth, Reinhard Kissner
and Antonio Togni*

Full Research Paper

Open Access

Address:
Department of Chemistry and Applied Biosciences, Swiss Federal
Institute of Technology (ETH Zürich), Wolfgang-Pauli-Str. 10,
CH-8093 Zürich, Switzerland

Email:
Antonio Togni* - atogni@ethz.ch

* Corresponding author

Keywords:
cyclic voltammetry; differential scanning calorimetry; electrophilic
trifluoromethylation; ¹⁹F NMR kinetics; nitration; organo-fluorine

Beilstein J. Org. Chem. 2014, 10, 1–6.
doi:10.3762/bjoc.10.1

Received: 23 September 2013
Accepted: 18 November 2013
Published: 02 January 2014

This article is part of the Thematic Series "Organo-fluorine chemistry III".

Guest Editor: D. O'Hagan

© 2014 Santschi et al; licensee Beilstein-Institut.
License and terms: see end of document.

Abstract

The synthesis of 5-nitro-1-(trifluoromethyl)-3*H*-1λ³,2-benziodaoxol-3-one (**3**), a hypervalent-iodine-based electrophilic trifluoromethylating reagent, is described. Whereas considerations based on cyclic voltammetry and X-ray structural properties would predict an inferior reactivity when compared to the non-nitrated derivative **2**, ¹⁹F NMR kinetic studies showed that this new derivative is almost one order of magnitude more reactive. Furthermore, differential scanning calorimetry measurements indicated that, in addition, it is also safer to handle.

Introduction

Since the advent of the hypervalent-iodine-based electrophilic trifluoromethylation reagents **1** and **2** in 2006 they have found widespread application in organic synthesis (Figure 1) [1-4]. Recently, increasing interest has been directed towards the photocatalytic one-electron reduction of these compounds in order to generate the highly electrophilic trifluoromethyl radical [5-7].

For example, Gouverneur et al. have highlighted the regioselective allylic trifluoromethylation employing reagent **2**, [Ru(bpy)₃]Cl₂ and allylsilanes as substrates [7]. In this context,

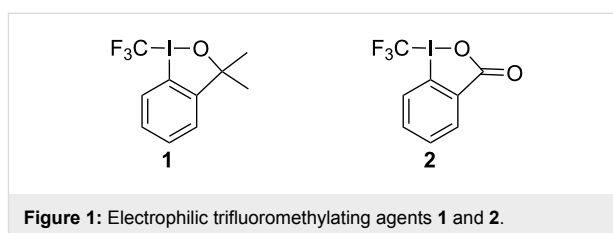

Figure 1: Electrophilic trifluoromethylating agents **1** and **2**.

also extensive electrochemical characterizations of various electrophilic trifluoromethylating agents are now available [8]. These studies reported cathodic peak potentials versus the

Ag/Ag⁺ pair of -1.82 V and -1.10 V for **1** and **2**, respectively. Therefore, we contemplated the possibility of enhancing the reactivity of reagent **2** by rendering its scaffold less electron-rich. This was to be achieved through the introduction of a strongly electron-withdrawing substituent in *para*-position to the iodine atom, potentially also leading to a more positive standard reduction potential. Therefore, based on a recent report by Togo et al. [9], the nitration of the reagent scaffold to afford the new derivative 5-nitro-1-(trifluoromethyl)-3*H*-1 λ^3 ,2-benziodaoxol-3-one (**3**) was taken into consideration.

Results and Discussion

The direct nitration of 2-iodobenzoic acid (**4**) has been reported before and was carried out on a 10 gram scale in a mixture of HNO₃ and H₂SO₄ at 135 °C (Scheme 1) [10]. Reductive work-up using an aqueous acidic solution of potassium iodide furnished the desired product **5** in 11–46% yield (29% average yield of four experiments). Subsequent oxidation was centered on an improved synthesis of reagent **2** employing trichloroisocyanuric acid (TCICA) as cheap, stoichiometric oxidant, as recently reported from our laboratory [11]. Although compound **5** was readily converted to **6** in hot MeCN with TCICA in 90% yield an alternative protocol was found advantageous in terms of overall reaction time, solvent consumption and time required to dry the product. Consequently, treatment of **5** in a mixture of DCM/*t*-BuOH 9:1 at 0 °C with *t*-BuOCl under exclusion of light led to the immediate precipitation of 1-chloro-5-nitro-3*H*-1 λ^3 ,2-benziodaoxol-3-one (**6**) in 81–93% yield (89% average yield of five experiments). This step was routinely carried out on a 3 gram scale in less than 5 minutes. Finally, introduction of the trifluoromethyl group was achieved by stirring **6** and anhydrous KF in hot MeCN, followed by treatment with Ruppert–Prakash reagent (TMSCF₃) at 0 °C yielding 10–35% of the desired product **3** as a pale yellow solid. Unfortunately, a slightly more economic route employing KOAc instead of KF was not feasible. Additionally, the purity of the product obtained was dependent on the grade of KF that was used. Therefore, spray-dried KF (99%) was further flame-dried under high vacuum immediately before use.

Inspection of the ¹³C NMR chemical shift of the quaternary phenyl carbon attached to iodine (C_{Ar-I}) in **5** and comparison to literature data available for 2-iodobenzoic acid (**4**) indeed confirmed the installation of an electron-poor center [12]. Hence, in the parent acid **4** C_{Ar-I} gives rise to a signal at 94.1 ppm and in **5** the corresponding carbon atom is deshielded by 9.6 ppm and observed at 103.7 ppm. The same observation holds true for **6** and its unmodified analogue **7** (104.0 ppm versus 94.1 ppm, $\Delta\delta = 9.9$ ppm) as well as for **3** and **2** (121.8 ppm versus 114.8, $\Delta\delta = 7$ ppm). Furthermore, this comparison highlights that the replacement of the chlorine atom by the CF₃ group to a certain degree compensates the electronic effects imposed by the NO₂ group as indicated by the lessened extent of deshielding. Nitration also had a distinct effect on the electronic spectrum of the final reagent. Solutions of **2** and **3** in DMSO/H₂O 1:1 were studied at concentrations of 9.7×10^{-5} M and 9.1×10^{-5} M, respectively. A graphic representation of the molar absorptivity ϵ vs. the corresponding wavelengths is presented in Figure 2. Parent reagent **2** features an absorbance maximum at $\lambda_{\max} = 237$ nm ($\epsilon = 4.3 \times 10^3$ M⁻¹ cm⁻¹) and two

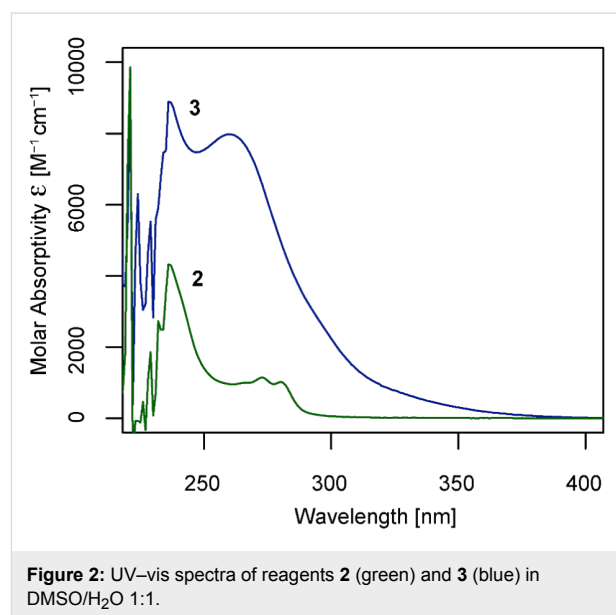
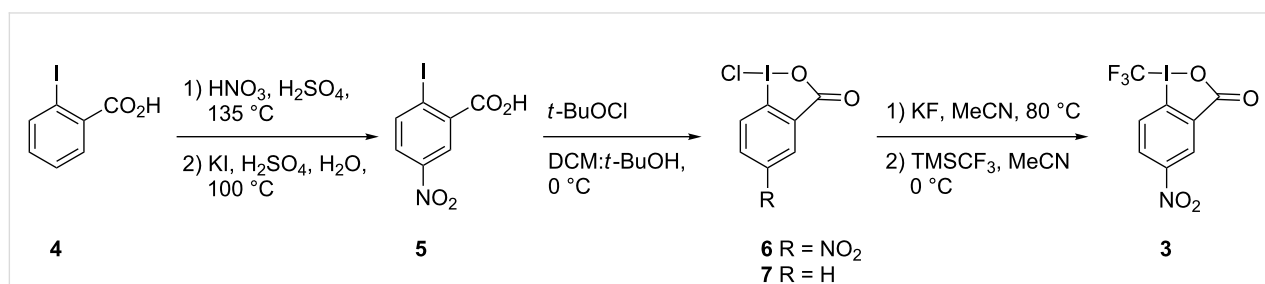

Figure 2: UV-vis spectra of reagents **2** (green) and **3** (blue) in DMSO/H₂O 1:1.



Scheme 1: Synthesis of 5-nitro-1-(trifluoromethyl)-3*H*-1 λ^3 ,2-benziodaoxol-3-one (**3**).

resolved sidebands at 272 nm ($\epsilon = 1.1 \times 10^3 \text{ M}^{-1} \text{ cm}^{-1}$) and 280 nm ($\epsilon = 1.0 \times 10^3 \text{ M}^{-1} \text{ cm}^{-1}$), respectively. In contrast, the nitrated product **3** exhibits a maximum $\lambda_{\text{max}} = 236 \text{ nm}$ ($\epsilon = 8.9 \times 10^3 \text{ M}^{-1} \text{ cm}^{-1}$) and features a broad sideband ranging from 260 nm ($\epsilon = 8.0 \times 10^3 \text{ M}^{-1} \text{ cm}^{-1}$) up to 350 nm, hence accounting for its pale yellow coloration. Generally, these observations are in line with data reported on the analogous pair of iodobenzene and 1-iodo-4-nitrobenzene [13,14]. However, whereas the broad sideband in 1-iodo-4-nitrobenzene is usually observed around 300 nm, a strong hypsochromic shift of roughly 40 nm is observed for **3**. This can be explained by the installation of the hypervalent bond and the presence of the strongly electron-withdrawing CF_3 group, as also indicated by the carbon chemical shift analysis.

Compounds **6** and **3** were also characterized by means of X-ray crystallography. Due to the very poor solubility of **6** in most common solvents, suitable single crystals for solid-state analysis were grown from a saturated solution in hot MeCN that was slowly cooled to $-20 \text{ }^\circ\text{C}$. Similarly, suitable crystals of reagent **3** were obtained from a boiling solution in bromobenzene. Whereas **6** crystallizes in plain sheets, **3** forms zig-zag-shaped layers. ORTEP representations of compounds **6** and **3** are given in Figure 3. Selected bond lengths and angles of **6**, **3** and the parent compounds **7**, **2** are summarized in Table 1.

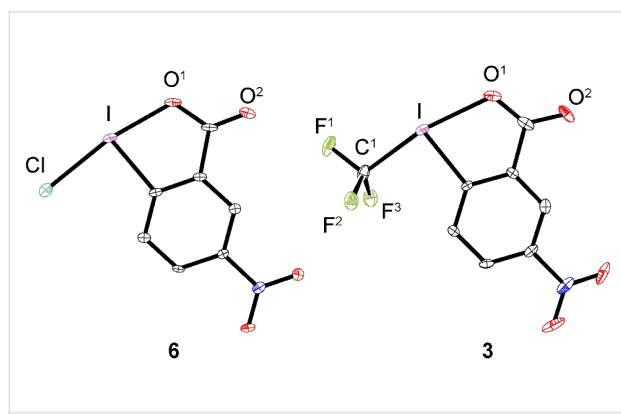

Figure 3: ORTEP representation of X-ray structures **6** and **3**. Thermal ellipsoids set to 30% probability. Hydrogen atoms omitted for clarity.

Table 1: Selected bond lengths and angles for compounds **2**, **3**, **6**, **7**.

Entry	I–X [Å] X = Cl, CF_3	I–O ¹ [Å]	O ¹ –I–X [°] X = Cl, CF_3
7 ^a	2.461(1)	2.091(3)	171.96(8)
6	2.4409(11)	2.148(3)	170.52(8)
2 ^b	2.219(4)	2.283(2)	170.49(12)
3	2.200(6)	2.306(4)	169.01(17)

^aReference [15]. ^bReference [1].

Both structures are stabilized by intermolecular hydrogen bonds ($\text{NO}_2 \cdots \text{H–Ar}$) [16] and by short intermolecular I–O² contacts, as typical for this class of compounds (see Supporting Information File 1). These structural findings also account for the slow dissolution kinetics observed.

Generally, the introduction of the NO_2 functionality is associated with a shortening of the I–X bond ($\Delta = 0.0201 \text{ \AA}$ for X = Cl; $\Delta = 0.019 \text{ \AA}$ for X = CF_3) and concomitant elongation of the I–O¹ bond ($\Delta = 0.057 \text{ \AA}$ for X = Cl; $\Delta = 0.023 \text{ \AA}$ for X = CF_3). Furthermore, the O¹–I–X angles are comparable for all four structures being 1 to 1.5° smaller for the nitro-substituted compounds. When comparing the same unit I–X within the analogous compounds **2** and **3**, a shorter bond would intuitively correspond to a stronger bond. Therefore, based on simple geometrical parameters, reagent **3** was expected to be slightly less reactive compared to **2**, meaning that reductive cleavage of the I– CF_3 bond should display a higher activation barrier.

Recently, differential scanning calorimetry (DSC) measurements for reagent **2** and its precursors were published indicating a decomposition energy of 159 kJ/mol (502 J/g) for **2** [17]. Furthermore, a Koenen test suggested explosiveness. Consequently in light of these results, DSC measurements of **2** and **3** were carried out in order to assess the thermal stability of the new derivative. These measurements were performed in punctured Al_2O_3 pans with a heating rate of 10 K/min. For reagent **2**, a decomposition energy of 138 kJ/mol (438 J/g, slightly lower than reported) with a maximum heat flow of 3.7 kW/mol (11.9 W/g) was found. Intriguingly, compound **3** features a significantly lower decomposition energy of only 99 kJ/mol (273 J/g) and a maximum heat flow of 2.2 kW/mol (6.2 W/g), therefore indicating that it should be safer to handle than parent compound **2** (Figure 4). The higher temperature of decomposition of 25 °C for **3**, as measured by the difference of the corresponding temperatures at peak heat flow, is believed to directly result from the additional stabilization of **3** by intermolecular H-bonding (vide supra).

Additionally, in order to test the initial hypothesis that nitration may lead to a more positive reduction potential, cyclic voltammetry (CV) measurements were carried out. These experiments were conducted under an atmosphere of nitrogen in anhydrous MeCN with Bu_4NBF_4 (0.1 M) as supporting electrolyte. A platinum working electrode and a Ag/Ag^+ (0.1 M AgBF_4 in MeCN) reference electrode were employed with a scan rate of 0.1 V/s. Analysis of the resulting cyclic voltammogram of a 1 mM solution of **3** revealed three quasi-reversible processes with cathodic peak potentials (E_{pc}) of -1.2 , -1.7 and -1.8 V , respectively (Figure 5). Subsequently, through addition of methyl 2-iodo-5-nitrobenzoate (1 mM), the first wave could be unambiguously

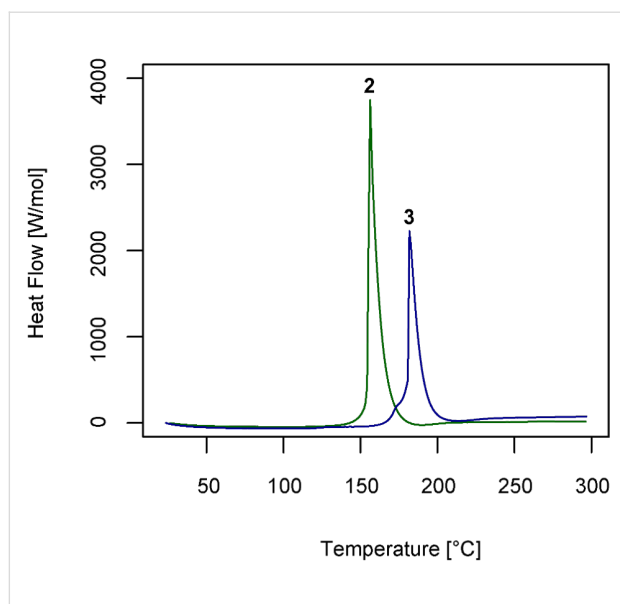

Figure 4: DSC traces obtained for **2** (green) and **3** (blue).

identified as the reduction of the hypervalent bond. Therefore, the more negative waves most likely correspond to the reduction of the nitro group and/or further reduction of iodine as reported in CV studies carried out on bis(acetoxy)iodobenzene [18].

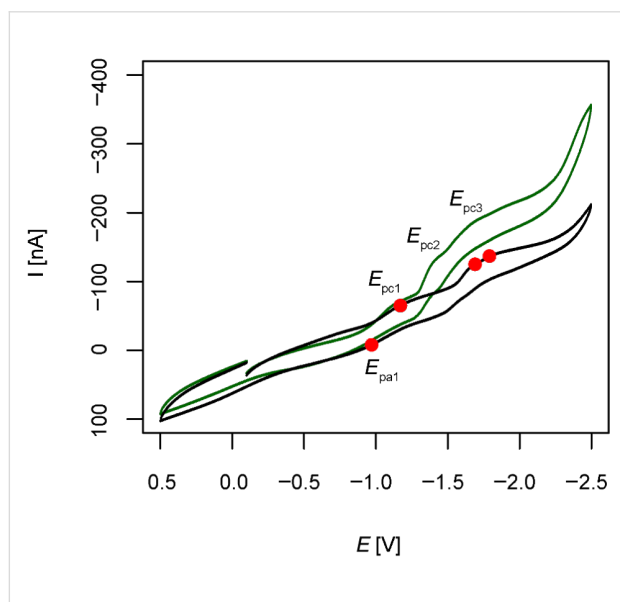

Figure 5: Cyclic voltammetry of **3** (1 mM, black) and of a mixture of **3** (1 mM) and methyl 2-iodo-5-nitrobenzoate (1 mM, green) in anhydrous MeCN + 0.1 M Bu_4NBF_4 , platinum electrode, scan rate = 0.1 V/s.

For the first wave $E_{pc1} = -1.17$ and $E_{pa1} = -0.97$ were determined, indicating a standard reduction potential $E_{1/2}^0 = -1.1$ V vs the Ag/Ag^+ pair. These values are comparable to the ones

reported for reagent **2** ($E_{pc} = -1.1$ V vs Ag/Ag^+ , scan rate 0.2 V/s, MeCN) [8]. Therefore, nitration did not influence the standard reduction potential significantly and **3** should behave in a comparable manner as **2**. These electrochemical findings are in line with the expectations of reactivity based on the X-ray structural considerations.

Finally, the decomposition kinetics of both reagents in a model system were studied providing insights into their relative reactivities. To this end, the reaction of **2** and **3** with *p*-toluenesulfonic acid monohydrate to **4** and **5**, respectively, was monitored in MeCN by means of ^{19}F NMR spectroscopy (Figure 6). Limitations arose from the poor solubility of **3** (1 mg in 0.25 mL MeCN) and, in the case of **2**, from line broadening resulting after the addition of the substrate, hence necessitating recording of 6 kinetic traces per reagent. Reagent **3** exhibits an exponential decay whereas the concentration of **2**, on the same time scale, decreases linearly. Therefore, rate data for **3** were obtained by curve fitting according to an exponential rate law and the method of initial rates was applied to reagent **2**. Subsequently, the initial rates were transformed to the corresponding first-order rate constants under the assumption that for both

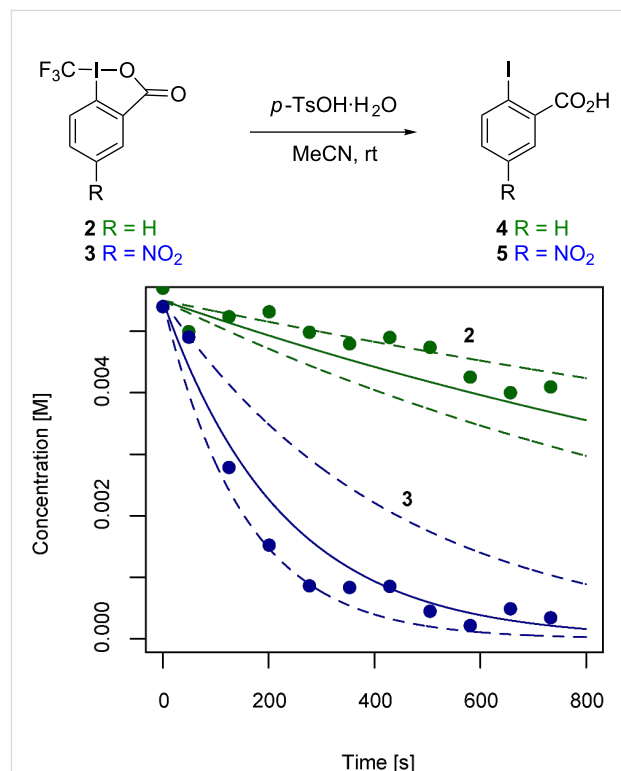

Figure 6: Sample kinetic traces for the decomposition of **2** (green) and **3** (blue) to **4** and **5**, respectively, upon reaction with *p*-TsOH in MeCN. Solid lines represent the average decay (k_{decomp}) based on 6 individual measurements and dashed lines are decays based on $k_{\text{decomp}} \pm \sigma$.

reagents the same mechanism of decay is operational. Indeed, the data imply that **3** ($k_{\text{decomp}} = 4.43 \pm 2.15 \times 10^{-3} \text{ s}^{-1}$) is less stable under the reaction conditions chosen and decays almost one order of magnitude faster than reagent **2** ($k_{\text{decomp}} = 5.46 \pm 2.23 \times 10^{-4} \text{ s}^{-1}$).

Conclusion

In conclusion, the new derivative **3** having an additional nitro functionality as compared to reagent **2** was successfully prepared and characterized. The resulting electronic modification was studied by analyzing carbon chemical shifts, UV–vis spectra and cyclic voltammetry. Whereas the first two methods clearly indicated the installation of an electron-poor center adjacent to iodine, cyclic voltammetry delivered a standard reduction potential comparable to the one of **2**. Notably, differential scanning calorimetric measurements indicate that the new reagent is thermally more stable. In presence of a proton source, however, increased lability of **3** was noted such that it decayed almost one order of magnitude faster than **2** under similar conditions. Therefore, the incorporation of an electron-withdrawing group into the reagent scaffold leads to an enhanced thermal stability that is paralleled by increased lability of the I–CF₃ bond under acidic conditions. However, the major drawback of the new modification is its low solubility, a problem that is currently being addressed in our group.

Experimental

2-Iodo-5-nitrobenzoic acid (5): During this preparation up to 25 mmol I₂ are formed. Therefore, the synthesis has to be conducted in a well-ventilated fume cupboard. Prepared according to literature procedure [10]. 2-Iodobenzoic acid (**4**, 10 g, 40.3 mmol, 1 equiv) was added to a mixture of HNO₃ (35 mL, 65%) and H₂SO₄ (85 mL, 95%). The solution was heated to 135 °C and stirred for 1 h. Subsequently, the resulting brown slurry was poured onto ice and the grey precipitate was filtered off and washed with copious amounts of water. Then, the filtrate was suspended in water (100 mL), heated to 100 °C and treated with a solution of KI (8.5 g, 51.2 mmol, 1.3 equiv) and H₂SO₄ (5 drops) in water (10 mL) over the course of 1 h. Finally, the brown suspension was filtered hot and washed with water to afford the pure product (**5**, 42%) as a brown solid. If impure product is obtained, boiling with water followed by hot filtration can be applied. Mp 195–198 °C; ¹H NMR (300 MHz, DMSO-*d*₆) δ 8.40 (d, *J* = 2.7 Hz, 1H), 8.29 (d, *J* = 8.6 Hz, 1H), 8.01 (dd, *J* = 8.6, 2.7 Hz, 1H), 4.00 (s, 1H); ¹³C NMR (75 MHz, DMSO-*d*₆) δ 166.5 (CO₂), 147.3 (CNO₂), 142.4 (CH *ortho* to CI), 138.2 (CCO₂), 126.1 (CH *para* to CCO₂), 124.1 (CH *ortho* to CCO₂), 103.7 (CI).

1-Chloro-5-nitro-3H-1λ³,2-benziodaoxol-3-one (6): To a solution of 2-iodo-5-nitrobenzoic acid (**5**, 1 g, 3.4 mmol,

1 equiv) in DCM/*t*-BuOH 9:1 (12 mL) at 0 °C *t*-BuOCl (0.42 mL, 3.7 mmol, 1.1 equiv) was added in one portion, taking care to shield this reagent from light. Stirring was continued for 20 min, the suspension was filtered and the filtrate washed with DCM to afford pure product (0.95 g, 86%) as a yellow solid. X-ray quality crystals were obtained by recrystallization from boiling MeCN. Mp 225 °C (dec); ¹H NMR (400 MHz, DMSO-*d*₆) δ 8.38 (d, *J* = 2.1 Hz, 1H), 8.26 (d, *J* = 8.6 Hz, 1H), 7.99 (dd, *J* = 8.5, 2.2 Hz, 1H); ¹³C NMR (101 MHz, DMSO-*d*₆) δ 166.3 (CO₂), 147.3 (CNO₂), 142.5 (CH *ortho* to CI), 137.9 (CCO₂), 126.2 (CH *para* to CCO₂), 124.2 (CH *ortho* to CCO₂), 104.1 (CI); HRMS–EI (*m/z*): [M]⁺ calcd for C₇H₃ClINO₄, 326.8795; found, 326.8775; Anal. calcd for C₇H₃ClINO₄: C, 25.68; H, 0.92; N, 4.28; found: C, 25.42; H, 1.02; N, 4.28.

5-Nitro-1-(trifluoromethyl)-3H-1λ³,2-benziodaoxol-3-one (3): Spray-dried KF (0.61 g, 10.3 mmol, 3 equiv) was flame-dried under high vacuum, then suspended with 1-chloro-5-nitro-3H-1λ³,2-benziodaoxol-3-one (**6**, 1 g, 3.1 mmol, 1 equiv) in dry MeCN (125 mL) under argon and stirred at 75 °C for 3.5 h, leading to the precipitation of a white solid. The suspension was cooled to 0 °C, TMSCF₃ (0.55 mL, 3.7 mmol, 1.2 equiv) was added and stirring continued for 2 h. The reaction mixture was filtered through a Celite pad. Subsequently, the organic layer was washed with brine (50% sat), dried over Na₂SO₄, and concentrated under reduced pressure to turbidity. Filtration and washing with MeCN afforded the pure product (0.35 g, 32%) as a pale yellow solid. If impure product is obtained, recrystallization from MeCN may be applied. X-ray quality crystals were obtained by recrystallization from boiling bromobenzene. Mp 163 °C (dec); ¹H NMR (300 MHz, DMSO-*d*₆) δ 8.68 (d, *J* = 2.6 Hz, 1H), 8.64 (dd, *J* = 8.9, 2.7 Hz, 1H), 8.08 (d, *J* = 8.8 Hz, 1H); ¹³C NMR (75 MHz, DMSO-*d*₆) δ 164.2 (CO₂), 149.9 (CNO₂), 134.8 (CCO₂), 130.0 (q, *J*_{CF} = 3.7 Hz, CH *ortho* to CI), 129.3 (CH *para* to CCO₂), 125.7 (CH *ortho* to CCO₂), 121.8 (CI), 106.6 (q, *J*_{CF} = 383.0 Hz, CF₃); ¹⁹F NMR (282 MHz, DMSO-*d*₆) δ –32.6; HRMS–EI (*m/z*): [M + H]⁺ calcd for C₈H₃F₃INaO₄, 383.8951; found, 383.8961; Anal. calcd for C₈H₃F₃INO₄: C, 26.62; H, 0.84; N, 3.88; found: C, 26.67; H, 0.93; N, 4.08.

Supporting Information

Supporting Information File 1

Experimental details, crystallographic data (selected intermolecular bond lengths) as well as a description of the ¹⁹F NMR monitoring experiments and data analysis.

[<http://www.beilstein-journals.org/bjoc/content/supplementary/1860-5397-10-1-S1.pdf>]

Acknowledgements

This work was supported by ETH Zürich. C. Mensing is gratefully acknowledged for recording the DSC traces.

References

- Eisenberger, P.; Gischig, S.; Togni, A. *Chem.–Eur. J.* **2006**, *12*, 2579–2586. doi:10.1002/chem.200501052
- Kieltsch, I.; Eisenberger, P.; Togni, A. *Angew. Chem., Int. Ed.* **2007**, *46*, 754–757. doi:10.1002/anie.200603497
- Macé, Y.; Magnier, E. *Eur. J. Org. Chem.* **2012**, 2479–2494. doi:10.1002/ejoc.201101535
- Liang, T.; Neumann, C. N.; Ritter, T. *Angew. Chem., Int. Ed.* **2013**, *52*, 8214–8264. doi:10.1002/anie.201206566
- Yasu, Y.; Koike, T.; Akita, M. *Angew. Chem., Int. Ed.* **2012**, *51*, 9567–9571. doi:10.1002/anie.201205071
- Yasu, Y.; Koike, T.; Akita, M. *Chem. Commun.* **2013**, *49*, 2037–2039. doi:10.1039/c3cc39235j
- Mizuta, S.; Engle, K. M.; Verhoog, S.; Galicia-López, O.; O'Duill, M.; Médebielle, M.; Wheelhouse, K.; Rassias, G.; Thompson, A. L.; Gouverneur, V. *Org. Lett.* **2013**, *15*, 1250–1253. doi:10.1021/ol400184t
- Mizuta, S.; Verhoog, S.; Wang, X.; Shibata, N.; Gouverneur, V.; Médebielle, M. *J. Fluorine Chem.* **2013**, *155*, 124–131. doi:10.1016/j.jfluchem.2013.07.006
- Iinuma, M.; Moriyama, K.; Togo, H. *Synlett* **2013**, *24*, 1707–1711. doi:10.1055/s-0033-1339283
- Goldstein, H.; Grampoloff, A. V. *Helv. Chim. Acta* **1930**, *13*, 310–314. doi:10.1002/hlca.19300130304
- Matoušek, V.; Pietrasiak, E.; Schwenk, R.; Togni, A. *J. Org. Chem.* **2013**, *78*, 6763–6768. doi:10.1021/jo400774u
- Ball, L. T.; Lloyd-Jones, G. C.; Russell, C. A. *Chem.–Eur. J.* **2012**, *18*, 2931–2937. doi:10.1002/chem.201103061
- Ungnade, H. E. *J. Am. Chem. Soc.* **1954**, *76*, 1601–1603. doi:10.1021/ja01635a040
- Forbes, W. F. *Can. J. Chem.* **1961**, *39*, 2295–2305. doi:10.1139/v61-304
- Takahashi, M.; Nanba, H.; Kitazawa, T.; Takeda, M.; Ito, Y. *J. Coord. Chem.* **1996**, *37*, 371–378. doi:10.1080/00958979608023567
- Allen, F. H.; Baalham, C. A.; Lommerse, J. P. M.; Raitby, P. R.; Sparr, E. *Acta Crystallogr., Sect. B: Struct. Sci.* **1997**, *53*, 1017–1024. doi:10.1107/S0108768197010239
- Fiederling, N.; Haller, J.; Schramm, H. *Org. Process Res. Dev.* **2013**, *17*, 318–319. doi:10.1021/op400035b
- Kokkinidis, G.; Papadopoulou, M.; Varvoglis, A. *Electrochim. Acta* **1989**, *34*, 133–139. doi:10.1016/0013-4686(89)87078-1

License and Terms

This is an Open Access article under the terms of the Creative Commons Attribution License (<http://creativecommons.org/licenses/by/2.0>), which permits unrestricted use, distribution, and reproduction in any medium, provided the original work is properly cited.

The license is subject to the *Beilstein Journal of Organic Chemistry* terms and conditions: (<http://www.beilstein-journals.org/bjoc>)

The definitive version of this article is the electronic one which can be found at: [doi:10.3762/bjoc.10.1](https://doi.org/10.3762/bjoc.10.1)

The difluoromethylene (CF₂) group in aliphatic chains: Synthesis and conformational preference of palmitic acids and nonadecane containing CF₂ groups

Yi Wang, Ricardo Callejo, Alexandra M. Z. Slawin and David O'Hagan*

Full Research Paper

Open Access

Address:
EaStCHEM School of Chemistry, University of St. Andrews, St.
Andrews, Fife KY16 9ST, UK

Email:
David O'Hagan* - do1@st-andrews.ac.uk

* Corresponding author

Keywords:
difluoromethylene; fatty acids; fluorination; organic fluorine chemistry;
organo-fluorine; palmitic acid

Beilstein J. Org. Chem. 2014, 10, 18–25.
doi:10.3762/bjoc.10.4

Received: 28 August 2013
Accepted: 22 November 2013
Published: 06 January 2014

This article is part of the Thematic Series "Organo-fluorine chemistry III".

Associate Editor: V. M. Dong

© 2014 Wang et al; licensee Beilstein-Institut.
License and terms: see end of document.

Abstract

The syntheses of palmitic acids and a nonadecane are reported with CF₂ groups located 1,3 or 1,4 to each other along the aliphatic chain. Specifically 8,8,10,10- and 8,8,11,11-tetrafluorohexadecanoic acids (**6b** and **6c**) are prepared as well as the singly modified analogue 8,8-difluorohexadecanoic acid (**6a**). Also 8,8,11,11-tetrafluorononadecane (**27**) is prepared as a pure hydrocarbon containing a 1,4-di-CF₂ motif. The modified palmitic acids are characterized by differential scanning calorimetry (DSC) to determine melting points and phase behaviour relative to palmitic acid (62.5 °C). It emerges that **6c**, with the CF₂ groups placed 1,4- to each other, has a significantly higher melting point (89.9 °C) when compared to the other analogues and palmitic acid itself. It is a crystalline compound and the structure reveals an extended *anti*-zig-zag chain. Similarly 8,8,11,11-tetrafluorononadecane (**27**) adopts an extended *anti*-zig-zag structure. This is rationalized by dipolar relaxation between the two CF₂ groups placed 1,4 to each other in the extended *anti*-zig-zag chain and suggests a design modification for long chain aliphatics which can introduce conformational stability.

Introduction

The selective replacement of hydrogen by fluorine is widely practised in bio-organic and medicinal chemistry [1-4]. It is generally perceived that fluorine exerts only a moderate steric influence relative to hydrogen in organic compounds, but that the electronegativity of fluorine can have significant electronic

influences [5]. The difluoromethylene (CF₂) functionality has received considerably less attention as a functional group for modifying the properties of organic molecules, relative to -F and -CF₃ groups. However we have recently become interested in the CF₂ group, and in particular have noticed that the replace-

ment of the two hydrogen atoms of a methylene by two fluorine atoms leads to widening of the C–CF₂–C angle (~118°) and a narrowing of the F–C–F angle (104°) relative to tetrahedral geometry [6,7]. This deviation of classical sp³, towards sp² hybridisation, imparts certain properties to the CF₂ group in that it can accommodate angle strain. For example CF₂ compounds display an apparent Thorpe–Ingold effect relative to CH₂ in ring closing metathesis reactions (RCM) to cycloheptene [8]. Comparison of the rates of reaction with different substituents at the C-5 position of the diene precursors **1a–d**, revealed that the CF₂ substituent in **1c** was as effective as the dicarboxylate **1a** or ketal **1b** in promoting RCM (Figure 1). This is attributed to C–CF₂–C angle widening, which absorbs angle strain in the resultant cycloheptene **2c**.

In another study we have prepared cyclododecanes **3–5** with regiospecific placement of two CF₂ groups around the ring [6] (Figure 2). X-ray structures reveal that the CF₂ groups only ever occupy corner locations. This is a result of several factors including C–CF₂–C angle widening, which relaxes 1,4-torsional strain across corner positions, lengthening the contact distance between those H(1)⋯H(4) interactions relative to those with CH₂ at the corner. Also if the CF₂ locates at an edge this would require that a C–F bond project into the middle of the ring. The larger steric influence of the fluorine, projecting into the tightly packed arrangement of endo orientated hydrogen atoms, raises the energy of such conformations. For cyclododecane, placing the CF₂ groups 1,4 (**3**) or 1,7 (**4**) to each other, stabilizes the [3.3.3.3] square like conformation of the ring. However if the

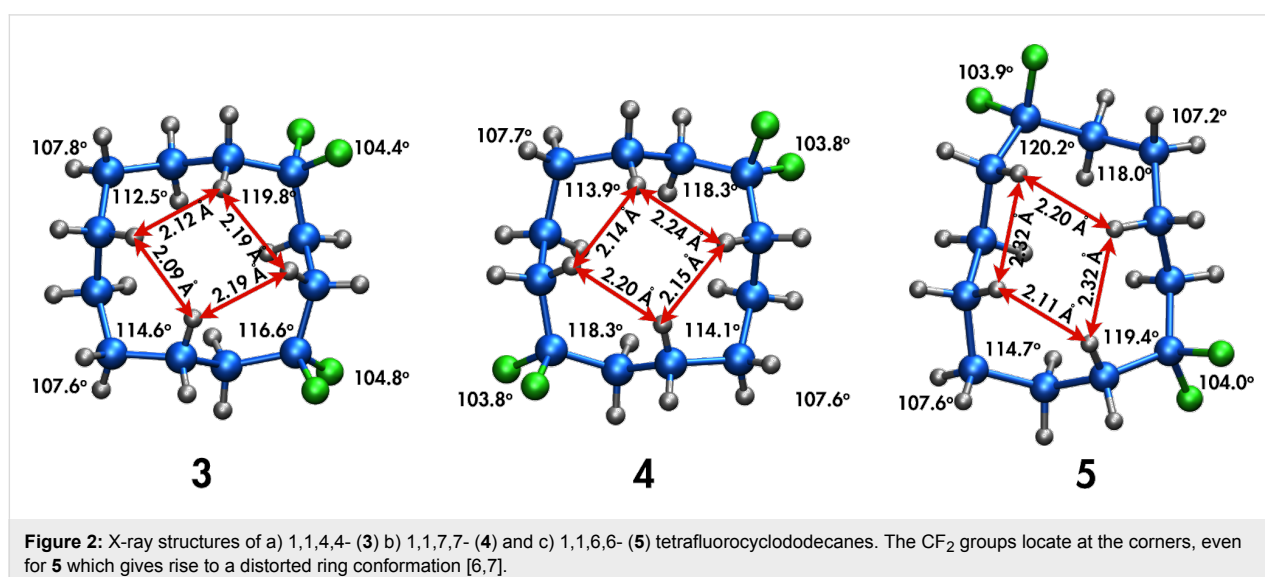
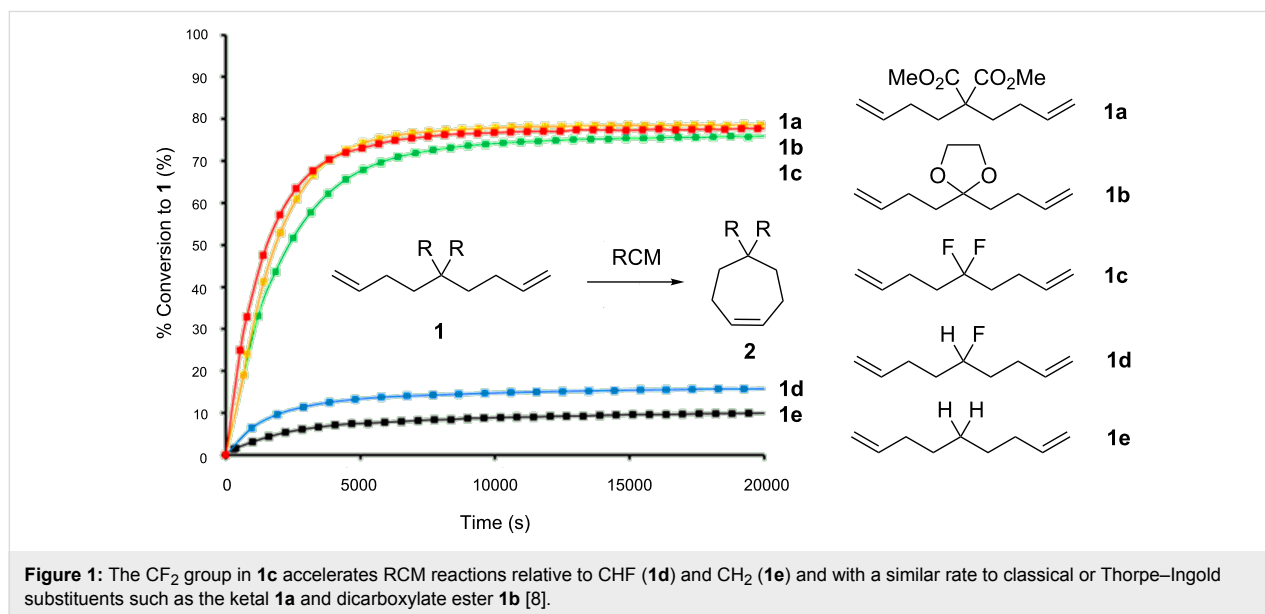

CF₂ groups are placed 1,6 to each other as in **5**, this introduces considerable distortion of the ring conformation as shown in Figure 2, because the CF₂ avoids an edge location, which would place a fluorine atom *endo* and unfavourably into the centre of the ring.

As part of an on-going interest in the behaviour and influence of the CF₂ group we have now explored the effect of locating two CF₂ groups along an extended aliphatic chain. Long chain fatty acids present tractable model systems as they are solid materials and their physical properties are well described [9]. In this study we selected the three palmitic acid analogues **6a–c** shown in Figure 3, as targets for synthesis and comparative analysis.

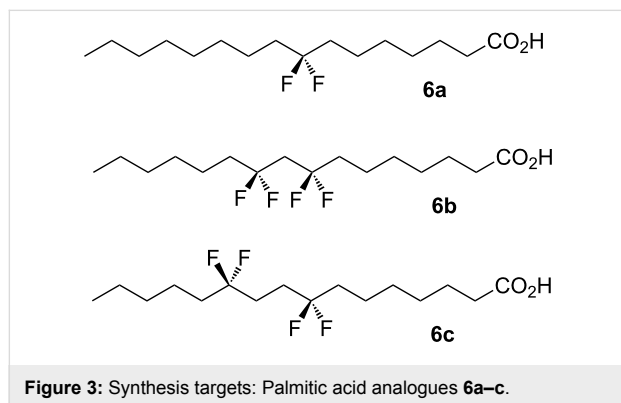

Palmitic acid **6a** containing a single CF₂ group at C-8 was prepared as a control compound. The location for CF₂ substitution in the middle of the aliphatic chain was selected as it is sufficiently remote from the carboxylic acid head group to have

any electronic influence. Two additional analogues **6b** and **6c** were prepared, each with two CF₂ groups, located 1,3 and 1,4 from each other respectively. These targets were designed to explore the significance on properties and chain stability of co-locating the CF₂ groups at different distances from each other.

Results and Discussion

Synthesis of the palmitic acids **6a–c**

As a general strategy palmitic acids **6a–c** were prepared by aryl oxidation of long chain pentadecabenzenes [10,11]. The introduction of the CF₂ groups was carried out by treatment of the appropriate precursor ketone with diethylaminosulfur trifluoride (DAST) [12,13]. The synthesis of palmitic acid **6a** is illustrated in Scheme 1. At the outset aldehyde **8** was condensed with the acetylide of 1-octyne to afford propargylic alcohol **9**, an alcohol which was readily oxidized to ketone **10**. Treatment with DAST afforded difluoromethyleneacetylene **11** in good yield. The fluorination of propargylic ketones, to generate difluoromethyleneacetylenes, is methodology developed by Grée et al. [14–18] and it proved to be very reliable in our hands. An efficient hydrogenation generated the C-8 substituted difluoromethylenepentadecabenzene **12**. Finally biphasic ruthenium tetroxide-catalyzed aryl oxidation gave the palmitic acid **6a** in 24% overall yield as illustrated in Scheme 1 [10,11].

For palmitic acid **6b**, it was required to introduce the CF₂ groups 1,3 to each other. This was achieved by sequential preparation of appropriate precursor ketones as illustrated in Scheme 2. For the first CF₂ group ketone **14** was treated with DAST. Conversion to the CF₂ group occurred in modest (45%) yield. Generally aliphatic ketones are less efficiently converted

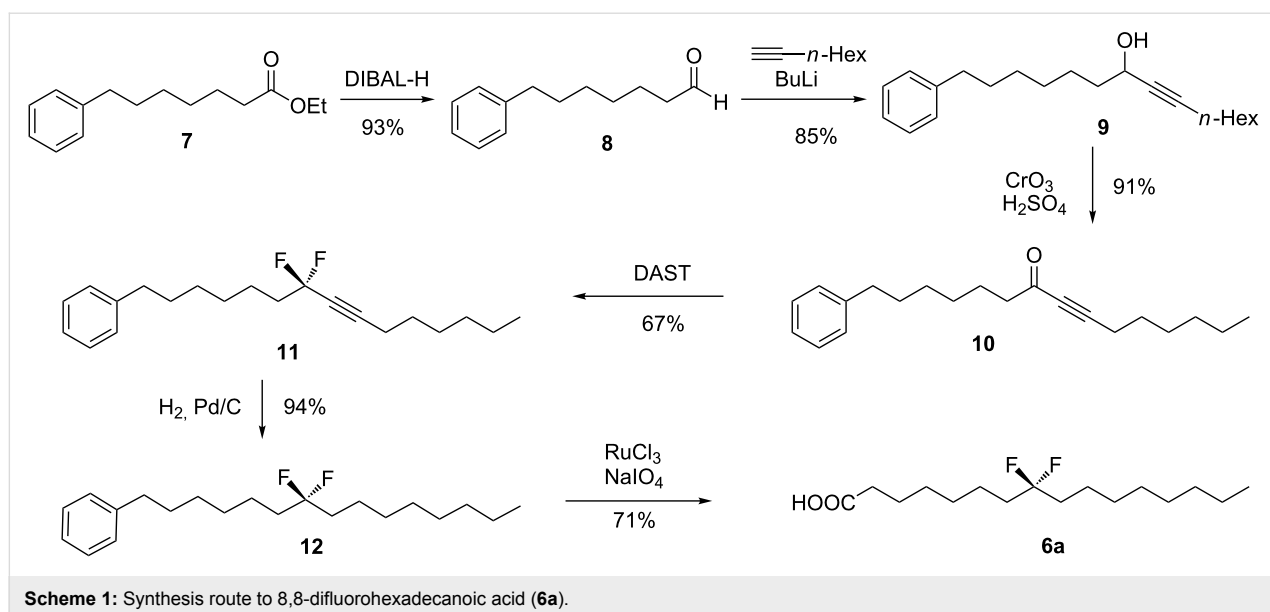

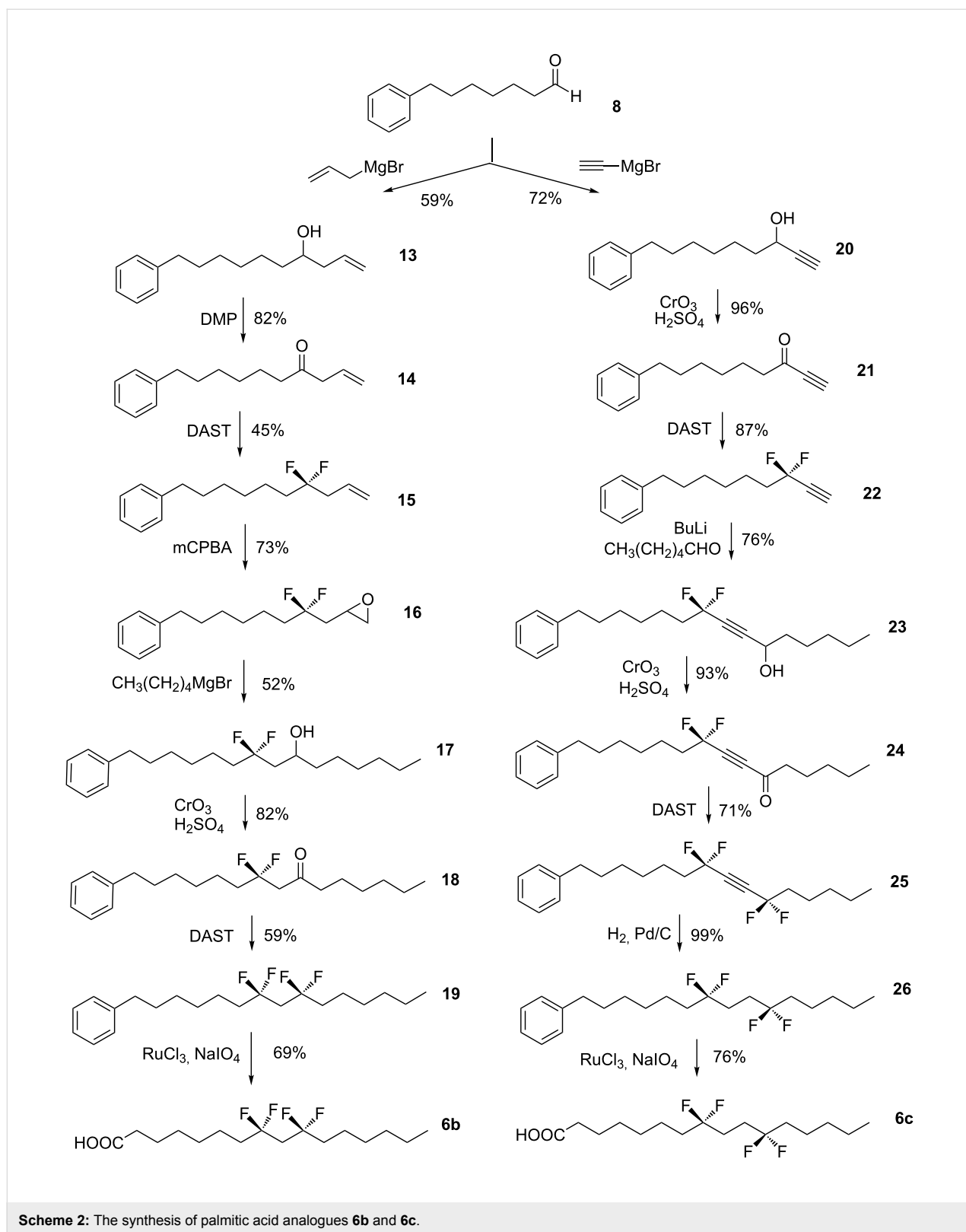

to CF_2 groups with DAST in comparison to propargylic ketones. Progression of the resultant CF_2 containing olefin **15** by epoxidation, chain extension and then oxidation, to ketone

18, generated the second fluorination substrate of the synthesis. DAST treatment gave pentadecabenzene **19**, which was again oxidised by RuO_3 to the corresponding palmitic acid **6b**.

Palmitic acid **6c** was prepared again relying on the methodology developed by Grée et al. [14–17] for introduction of the CF₂ groups. Thus treatment of ketone **21** with DAST resulted in an efficient conversion to difluoromethyleneacetylene **22**. This terminal acetylene is amenable to acetylide formation on treatment with BuLi [19,20] and condensation with hexaldehyde gave propargylic alcohol **23**. The lithium methylenedifluoroacetylide (RCF₂C≡CLi) reaction to form a C–C bond, provides a particularly useful synthon to access this 1,4-di-CF₂ motif. Oxidation and then treatment of the resultant ketone **24**, with DAST generated the tetrafluoroacetylene **25**. Complete hydrogenation of the triple bond proved efficient and the resultant tetrafluoropentadecabenzene **26** was readily oxidized to palmitic acid **6c** as illustrated in Scheme 2. This completed the syntheses of the palmitic acid analogues **6a–c**.

Differential scanning calorimetry (DSC) data was then measured for all three of the palmitic acid samples **6a–c** over a temperature range of –150 to 400 °C. In this way accurate melting point values were obtained. The melting point of C-8 difluorinated palmitic acid **6a** (62.9 °C) was very similar to the

natural palmitic acid (62.5 °C), Thus a single CF₂ substitution, certainly at this location, has very little influence on the melting point. For palmitic acid **6b**, with the two CF₂-groups placed 1,3 to each other, the melting point (69 °C) is also similar to palmitic acid, but the phase behaviour is more complex as evidenced by the broad DSC profiles. This palmitic acid **6b** was amorphous in nature and was not a crystalline solid, unlike the other two analogues **6a** and **6c** which formed crystals (Figure 4).

The tetrafluorinated palmitic acid **6c**, with the CF₂ groups located 1,4 from each other displays a sharp and significantly higher melting point (89.9 °C) than the other two palmitic acids **6a** and **6b**.

Palmitic acids **6a** and **6c** were crystalline solids and single crystal X-ray diffraction data were obtained for these compounds. As described above analogue **6b** was amorphous in nature and despite considerable effort a single crystal could not be obtained for **6b**. The resultant structures for **6a** and **6c** are shown in Figure 5 and Figure 6 respectively. In each case two

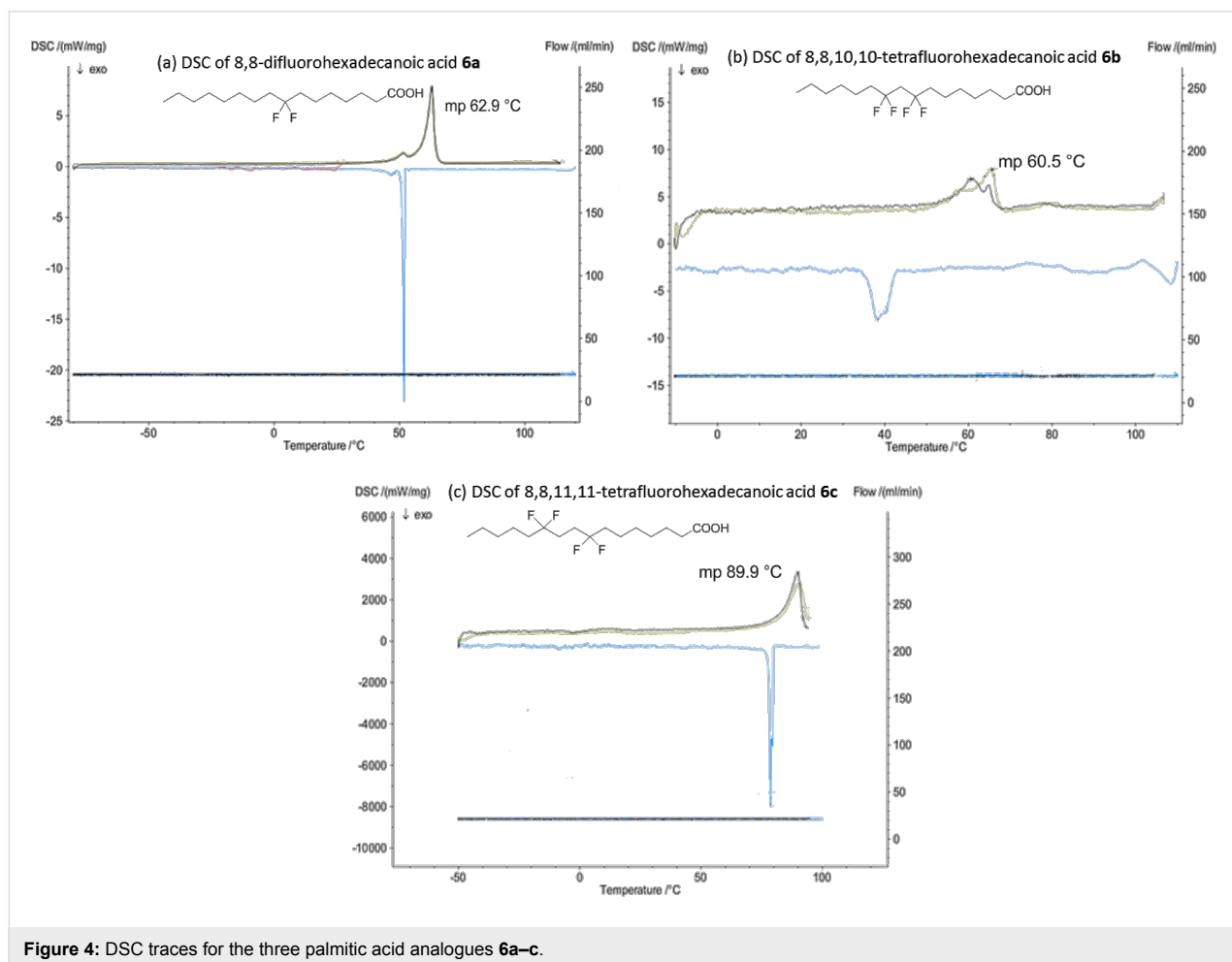
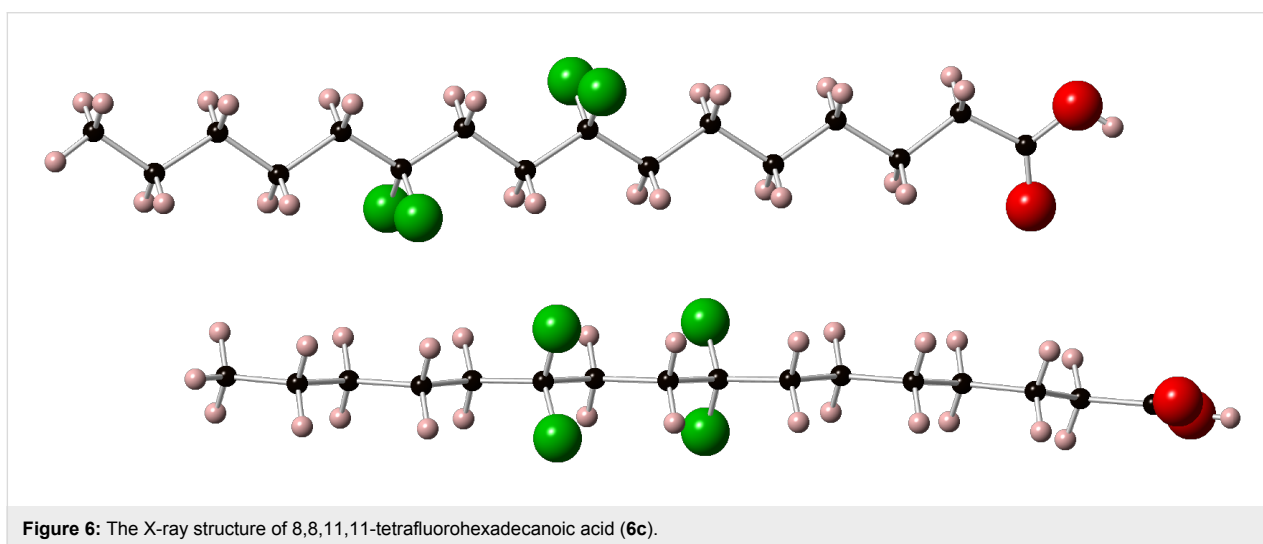
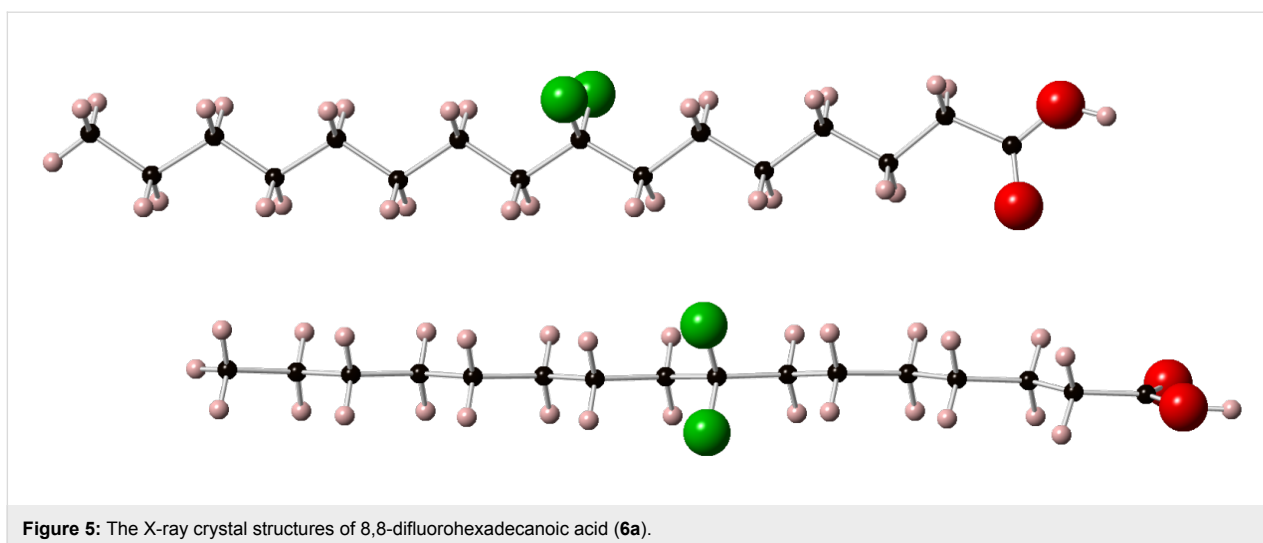
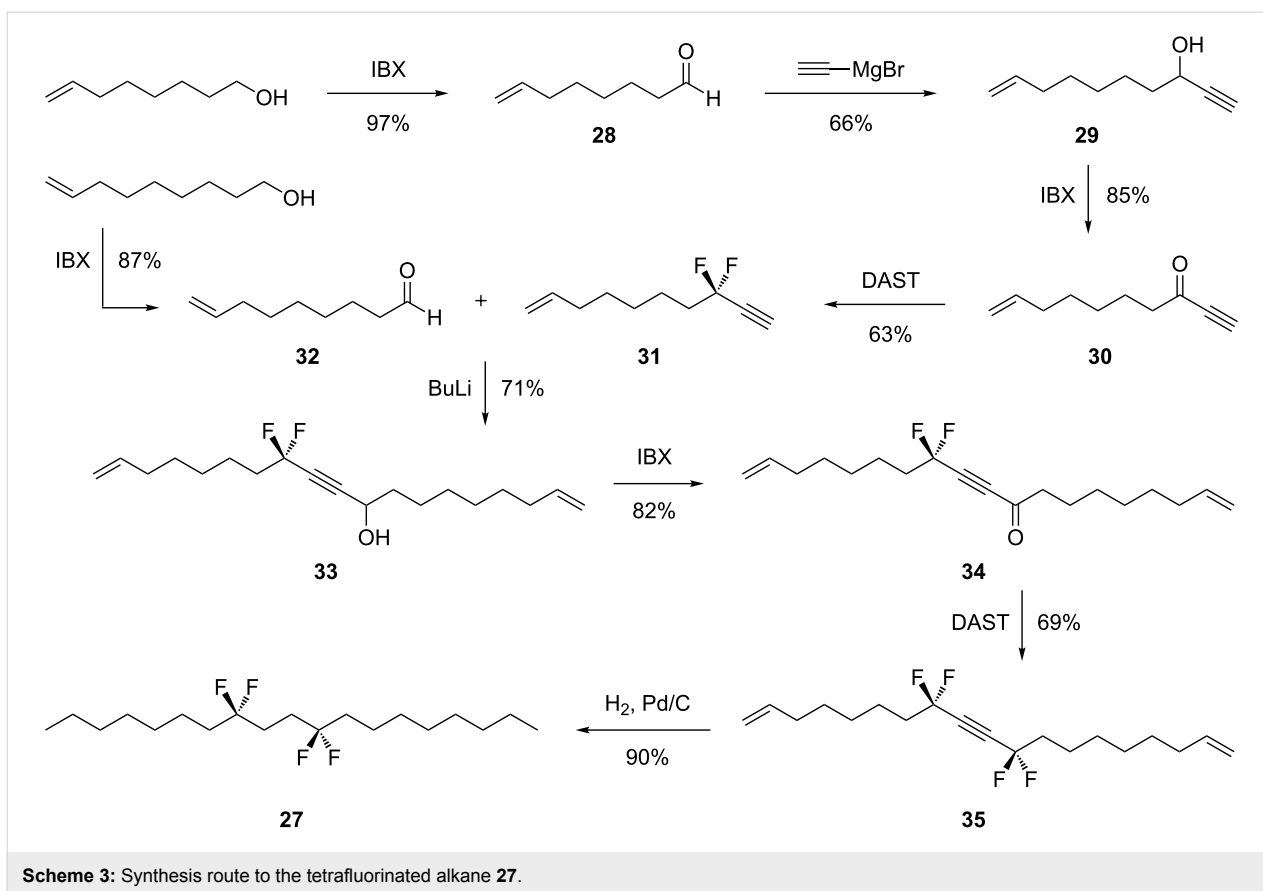

Figure 4: DSC traces for the three palmitic acid analogues **6a–c**.



molecules as they appear within the unit cell are presented in the image, allowing a view from above and to the side of the extended chain. The closest $\text{CF}\cdots\text{HC}$ contacts are 2.88 Å in **6a** and 2.85 Å in **6c**, much longer than any meaningful organic fluorine hydrogen bond [21]. The $\text{C}-\text{CF}_2-\text{C}$ angle in **6a** (Figure 5) is 117° and as expected, wider than the other $\text{C}-\text{CH}_2-\text{C}$ angles which are typically $\sim 112.5^\circ$. For **6c** (Figure 6) the $\text{C}-\text{CF}_2-\text{C}$ angles are 115.6° (at C-8) and 116.3° (at C-11) also consistently wider than the aliphatic $\text{C}-\text{CH}_2-\text{C}$ angles. The significantly higher melting point and good crystallinity of **6c** can be attributed to the relative orientation of the two CF_2 groups. They are pointing perfectly *anti*-parallel to each other such that their dipoles cancel out in the extended *anti*-zig-zag chain conformation. We are currently exploring if this is a special situation whereby CF_2 groups positioned 1,4 from each other can add conformational stability to aliphatic chains in other systems.

It occurred to us that the interactions of the carboxylate groups in palmitic acid **6c**, may be dictating overall stability and conformation of the alkyl chain in the solid state. Thus it appeared appropriate to prepare a true hydrocarbon chain to further investigate the conformational preference of the 1,4-di- CF_2 motif. Accordingly we selected to prepare tetrafluorononadecane **27**. This is a long chain hydrocarbon with the 1,4-di- CF_2 motif placed centrally. The synthetic route to **27** is illustrated in Scheme 3. The strategy for incorporating the two CF_2 groups followed that used for the preparation of palmitic acid **6c**. In this case propargylic ketone **30** was treated with DAST to generate difluoroacetylene **31**. The resultant acetylene could then be deprotonated for conjugation to aldehyde **32**. Oxidation and then fluorination of ketone **34** with DAST, introduced the second CF_2 group and generated tetrafluoroacetylene **35**. Finally hydrogenation of the central acetylene group gave the saturated tetrafluorononadecane **27**. This compound proved to



be a crystalline solid (mp 35–37 °C) with a melting point very similar to nonadecane (32–35 °C). A suitable crystal was subject to X-ray structure analysis and the resultant structure is shown in Figure 7. It is clear that the alkyl chain of **27** is extended in a similar conformation to that found in palmitic acid **6c** and we conclude that this is the preferred conformation of this motif in a hydrocarbon chain.

Conclusion

In conclusion, we have synthesised three palmitic acid analogues **6a–c** carrying regiospecifically located CF₂ groups. The tetrafluorononadecane **27** was also prepared as an example of a true hydrocarbon. Relatively efficient synthesis protocols were devised for placing the CF₂ groups 1,3 and 1,4 to each

other. The CF₂ groups of **6b**, **6c** and **27** were introduced sequentially from appropriate precursor ketones, using DAST. In particular, the methodology of Grée et al., enabled the efficient introduction of CF₂ groups from propargylic ketones in the syntheses of **6a**, **6c** and **27**. A useful C–C bond forming reaction involved a lithium methylenedifluoroacetylide (RCF₂C≡CLi) condensation with an aldehyde, offers an efficient strategy for the preparation of the 1,4-di-CF₂ motif after suitable functional group manipulations.

The non-crystalline nature of **6b** presumably arises due to chain disorder from linear 1,3-repulsions between the fluorines, so the preferred conformation of this motif could not be determined in this study. The melting point of palmitic acid **6c** (89.9 °C) was

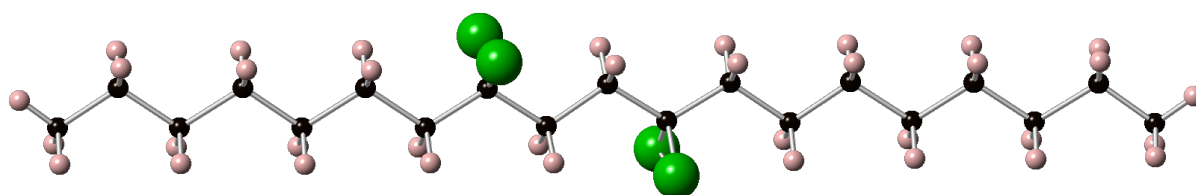

Figure 7: The X-ray structure of 8,8,11,11-tetrafluorononadecane (**27**).

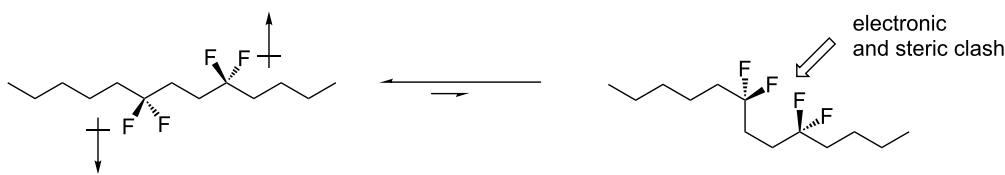

Figure 8: Conformational interconversion of 1,4-di- CF_2 motif.

notable in that it was significantly higher than that of the two other analogues **6a** and **6b**, and also of palmitic acid itself. The solid state structure of **6c** and **27** show that the 1,4-di- CF_2 motif prefers an *anti*-zig-zag conformation. We attribute this preference to intramolecular dipole–dipole relaxation which is maximised in the extended *anti*-zig-zag chain conformation (Figure 8). Also repulsive through space 1,4- $\text{F}\cdots\text{F}$ interactions will be disfavoured if the chain undergoes *gauche* conformational disorder. These contributing factors suggest that the 1,4-di- CF_2 motif ($\text{R}-\text{CF}_2\text{CH}_2\text{CH}_2\text{CF}_2-\text{R}$) will be useful for adding conformational stability to aliphatic chains.

Supporting Information

Supporting Information File 1

Experimental part.

[<http://www.beilstein-journals.org/bjoc/content/supplementary/1860-5397-10-4-S1.pdf>]

Acknowledgements

D.O'H. thanks the ERC for an Advanced Investigator Grant to support this research and Mrs S. Williamson (University of St Andrews) for DSC analyses.

References

- Müller, K.; Faeh, C.; Diederich, F. *Science* **2007**, *317*, 1881–1886. doi:10.1126/science.1131943
- Liu, W.; Huang, W.; Cheng, M.-J.; Nielson, R. J.; Goddard, W. A., III; Groves, J. T. *Science* **2012**, *337*, 1322–1325. doi:10.1126/science.1222327
- Jarchow-Choy, S. K.; Sjuvarsson, E.; Sintim, H. O.; Eriksson, S.; Kool, E. T. *J. Am. Chem. Soc.* **2009**, *131*, 5488–5494. doi:10.1021/ja808244t
- Purser, S.; Moore, P. R.; Swallow, S.; Gouverneur, V. *Chem. Soc. Rev.* **2008**, *37*, 320–330. doi:10.1039/b610213c
- O'Hagan, D. *Chem. Soc. Rev.* **2008**, *37*, 308–319. doi:10.1039/b711844a
- Skibiński, M.; Wang, Y.; Slawin, A. M. Z.; Lebl, T.; Kirsch, P.; O'Hagan, D. *Angew. Chem., Int. Ed.* **2011**, *50*, 10581–10584. doi:10.1002/anie.201105060
- O'Hagan, D.; Wang, Y.; Skibiński, M.; Slawin, A. M. Z. *Pure Appl. Chem.* **2012**, *84*, 1587–1595. doi:10.1351/PAC-CON-11-09-26
- Urbina-Blanco, C. A.; Skibiński, M.; O'Hagan, D.; Nolan, S. P. *Chem. Commun.* **2013**, *49*, 7201–7203. doi:10.1039/c3cc44312d
- Dasaradhi, L.; O'Hagan, D.; Petty, M. C.; Pearson, C. *J. Chem. Soc., Perkin Trans. 2* **1995**, 221–225. doi:10.1039/p29950000221
- Carlsen, P. H. J.; Katsuki, T.; Martin, V. S.; Sharpless, K. B. *J. Org. Chem.* **1981**, *46*, 3936–3938. doi:10.1021/jo00332a045
- O'Hagan, D. *J. Fluorine Chem.* **1989**, *43*, 371–377. doi:10.1016/S0022-1139(00)82723-2
- Middleton, W. J. *J. Org. Chem.* **1975**, *40*, 574–578. doi:10.1021/jo00893a007
- O'Hagan, D.; Al-Maharik, N. *Aldrichimica Acta* **2011**, *44*, 65–75.
- Prakesch, M.; Kerouedan, E.; Grée, D.; Grée, R.; DeChancie, J.; Houk, K. N. *J. Fluorine Chem.* **2004**, *125*, 537–541. doi:10.1016/j.jfluchem.2003.11.027
- Khalaf, A.; Grée, D.; Abdallah, H.; Jaber, N.; Hachem, A.; Grée, R. *Tetrahedron* **2011**, *67*, 3881–3886. doi:10.1016/j.tet.2011.03.073
- Bannwarth, P.; Valleix, A.; Grée, D.; Grée, R. *J. Org. Chem.* **2009**, *74*, 4646–4649. doi:10.1021/jo900674u
- Bannwarth, P.; Grée, D.; Grée, R. *Tetrahedron Lett.* **2010**, *51*, 2413–2415. doi:10.1016/j.tetlet.2010.02.116
- Pacheco, M. C.; Purser, S.; Gouverneur, V. *Chem. Rev.* **2008**, *108*, 1943–1981. doi:10.1021/cr068410e
- Pajkert, R.; Röschenthaler, G.-V. *J. Org. Chem.* **2013**, *78*, 3697–3708. doi:10.1021/jo400198a
- Drakesmith, F. G.; Stewart, O. J.; Tarrant, P. *J. Org. Chem.* **1968**, *33*, 280–285. doi:10.1021/jo01265a055
- Howard, J. A. K.; Hoy, V. J.; O'Hagan, D.; Smith, G. T. *Tetrahedron* **1996**, *52*, 12613–12622. doi:10.1016/0040-4020(96)00749-1

License and Terms

This is an Open Access article under the terms of the Creative Commons Attribution License (<http://creativecommons.org/licenses/by/2.0>), which permits unrestricted use, distribution, and reproduction in any medium, provided the original work is properly cited.

The license is subject to the *Beilstein Journal of Organic Chemistry* terms and conditions: (<http://www.beilstein-journals.org/bjoc>)

The definitive version of this article is the electronic one which can be found at: [doi:10.3762/bjoc.10.4](https://doi.org/10.3762/bjoc.10.4)

Organocatalytic asymmetric fluorination of α -chloroaldehydes involving kinetic resolution

Kazutaka Shibatomi*, Takuya Okimi, Yoshiyuki Abe, Akira Narayama, Nami Nakamura and Seiji Iwasa

Full Research Paper

Open Access

Address:

Department of Environmental and Life Sciences, Toyohashi University of Technology, 1-1 Hibiogaoka, Tempaku-cho, Toyohashi 441-8580, Japan

Email:

Kazutaka Shibatomi* - shiba@ens.tut.ac.jp

* Corresponding author

Keywords:

α -branched aldehyde; asymmetric catalysis; chlorination; fluorination; organocatalyst; organo-fluorine

Beilstein J. Org. Chem. **2014**, *10*, 323–331.

doi:10.3762/bjoc.10.30

Received: 25 October 2013

Accepted: 03 January 2014

Published: 04 February 2014

This article is part of the Thematic Series "Organo-fluorine chemistry III".

Guest Editor: D. O'Hagan

© 2014 Shibatomi et al; licensee Beilstein-Institut.

License and terms: see end of document.

Abstract

In a previous study it was shown that the enantioselective α -fluorination of racemic α -chloroaldehydes with a chiral organocatalyst yielded the corresponding α -chloro- α -fluoroaldehydes with high enantioselectivity. It was also revealed that kinetic resolution of the starting aldehydes was involved in this asymmetric fluorination. This paper describes the determination of the absolute stereochemistry of a resulting α -chloro- α -fluoroaldehyde. Some information about the substrate scope and a possible reaction mechanism are also described which shed more light on the nature of this asymmetric fluorination reaction.

Introduction

Fluorinated organic molecules are of considerable interest in pharmaceutical and agricultural chemistry owing to the unique properties of the fluorine atom [1,2]. These compounds, especially with one or more fluorinated stereogenic center(s), are fascinating building blocks for new drug candidates. Organocatalytic α -fluorination of aldehydes is known to be an efficient strategy for the enantioselective construction of fluorinated chiral carbon centers [3-6]; however, very few successful studies have been published on the fluorination of α -branched aldehydes [7]. During the course of our study on the enantioselective construction of such fluorinated stereogenic centers, we developed a method for the enantioselective synthesis of

α -chloro- α -fluoroaldehydes via the organocatalytic α -fluorination of α -alkyl- α -chloroaldehydes, a type of α -branched aldehyde, mediated by the Jørgensen–Hayashi catalyst **1** [8]. The reaction yielded the desired α -chloro- α -fluoroaldehydes with high enantioselectivity when the starting aldehyde was used in excess over *N*-fluorobenzenesulfonimide (NFSI) in the reaction. However, when an excess NFSI with respect to the starting aldehyde was used, poor asymmetric induction was observed. In this paper, we describe the determination of the absolute stereochemistry of a resulting α -chloro- α -fluoroaldehyde using this methodology and discuss the possible reaction mechanism that involves kinetic resolution.

Results and Discussion

In our previous study [8], enantioselective fluorination of racemic 2-chloro-3-phenylpropanal (**2a**) was carried out with 3 equiv of NFSI in the presence of organocatalyst (*S*)-**1** to yield the corresponding α -chloro- α -fluoroaldehyde **3a** in good conversion. Isolation of the product and determination of enantiomeric purity were performed after reduction to primary alcohol **4a** because **3a** was unstable to silica gel chromatography. The reaction afforded **4a** with high enantioselectivity along with the monochloro alcohol **5a**, whose enantiomeric purity was determined to be 37% ee (Scheme 1) [8]. These results suggested that kinetic resolution of the starting aldehydes was involved in this asymmetric fluorination.

To collect further information on the reaction mechanism, we sought to determine the absolute configuration of **4a**. Recently, we reported the enantioselective synthesis of α -chloro- α -fluoro- β -keto esters via the sequential chlorination–fluorination of β -keto esters with the Cu(II) complex of SPYMOX [9], a spiro chiral oxazoline ligand developed by our research group [9–12]. In that study, we succeeded in determining the absolute stereochemistry of the α -chloro- α -fluoro- β -keto ester **6** by the X-ray crystallographic analysis of its derivative **7** (Scheme 2). Here,

our aim was to transform chlorofluoro ester **6** to **4a** in order to compare its optical rotation with that of **4a** derived from **2a** in the presence of catalyst (*S*)-**1**. As shown in Scheme 3, β -keto ester **6** was converted via the Barton–McCombie deoxygenation [13] into a simple ester **10**, which was then reduced to the primary alcohol **4a** by treatment with LiAlH₄. Comparison of the optical rotations and retention times on chiral HPLC clearly showed that the asymmetric fluorination of **2a** catalyzed by (*S*)-**1** yielded **4a** having the *R* configuration (Scheme 1).

An investigation of the substrate scope of the organocatalytic fluorination of α -chloroaldehydes was performed as shown in Table 1. The reaction of **2a** with 3 equiv of NFSI yielded **4a** in 87% ee along with monochloro alcohol **5a** in 37% ee (Table 1, entry 2) as described above. On the other hand, the reaction with 2 equiv of NFSI against to **2a** showed poor enantioselectivity (31% ee, Table 1, entry 1). We also examined the reaction with 2 equiv of **2a** based on NFSI. The reaction yielded **4a** in 75% ee (lower ee than that in Table 1, entry 2), and the enantiomeric purity of the recovered **5a** was increased to 52% ee (Table 1, entry 3). Similar trends were observed in the fluorination with some other substrates **2b–2g** (Table 1, entries 4–14). These results strongly suggested that the high asym-

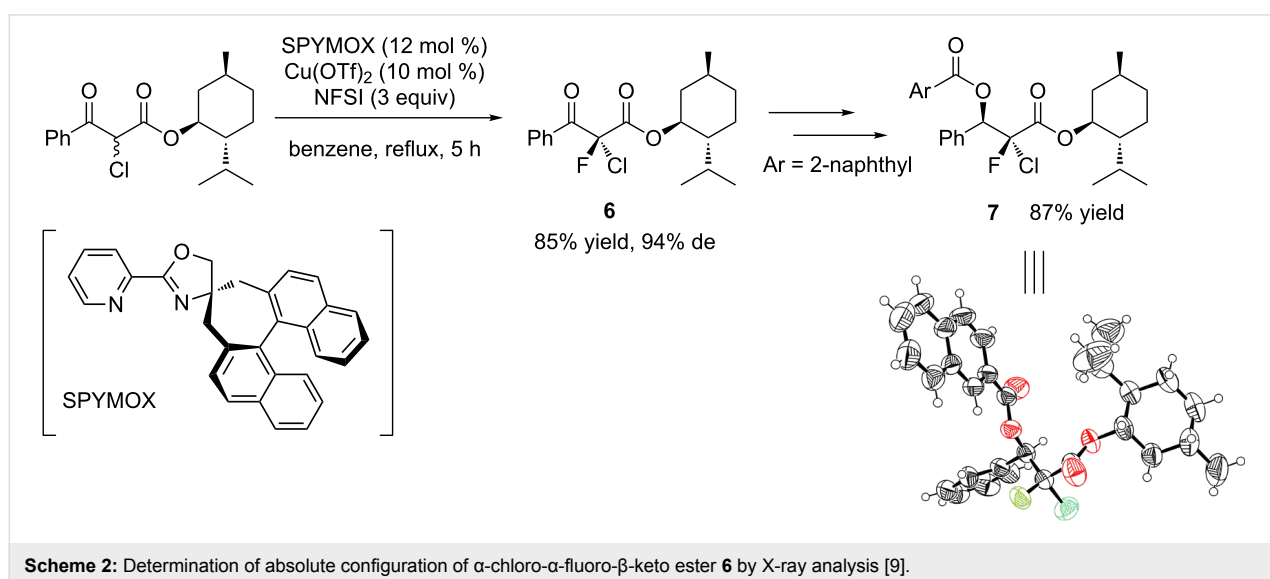
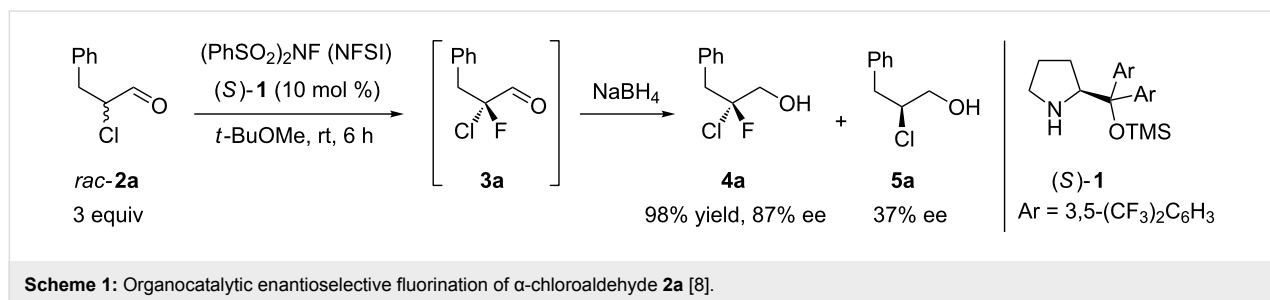

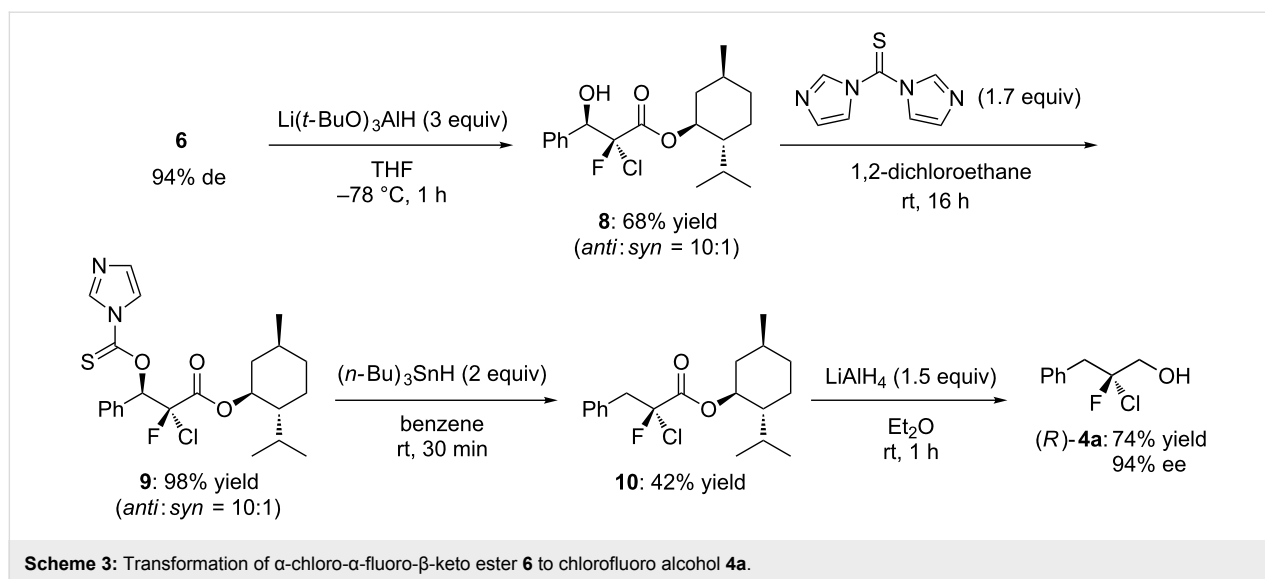
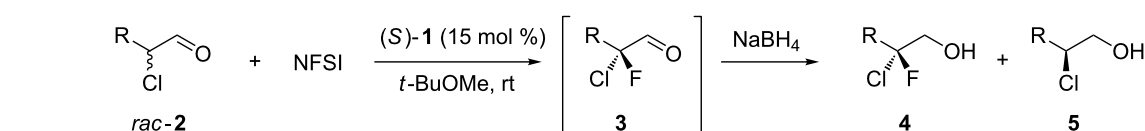
**Table 1:** Enantioselective fluorination of α -chloroaldehydes.^a

entry	R	2:NFSI	t (h)	% yield of 4 ^b	% ee of 4 ^c	% ee of 5 ^{c,d}
1 ^e	Bn (2a)	1:2	11	78	31 (<i>R</i>)	–
2 ^{e,f}	Bn	3:1	6	98	87 (<i>R</i>)	37 (<i>S</i>)
3	Bn	2:1	6	96	75 (<i>R</i>)	52 (<i>S</i>)
4	<i>n</i> -Hex (2b)	1:2	11	82	31	–
5 ^{e,f}	<i>n</i> -Hex	3:1	10	97	80	35 (<i>S</i>)
6	<i>n</i> -Hex	2:1	19	92	68	49 (<i>S</i>)
7	–(CH ₂) ₃ OCH ₂ OCH ₃ (2c)	1:2	19	83	23	–
8 ^f	–(CH ₂) ₃ OCH ₂ OCH ₃	3:1	10	90	78	33 (<i>S</i>)
9 ^f	–(CH ₂) ₃ CO ₂ Et (2d)	3:1	4	90	80	20
10 ^g	<i>c</i> -Hex (2e)	1:2	48	88	42	–
11 ^g	<i>c</i> -Hex	3:1	24	92	96	15
12	Ph (2f)	1:2	12	61	72	–
13 ^{e,f}	Ph	3:1	10	82	90	5
14 ^{e,g}	<i>t</i> -Bu (2g)	3:1	30	87	99	29

^aReactions were carried out in *t*-BuOMe with 15 mol % of (*S*)-**1** unless otherwise noted. ^bIsolated yield based on **2** or NFSI. ^cDetermined by chiral HPLC or GC analysis. ^dMonochloro alcohol **5** was recovered in nearly quantitative yield. ^eSimilar result was reported in Ref. [8]. ^f10 mol % of (*S*)-**1** was used. ^gReaction was carried out with 30 mol % of (*S*)-**1** at 30 °C.

metric induction in this fluorination requires not only control of enantiofacial selection during electrophilic fluorination of the enamine intermediates, but also a high level of kinetic resolution of the starting aldehydes.

From these results, we proposed a reaction mechanism for the fluorination of α -chloroaldehydes, as shown in Scheme 4. Cata-

lyst (*S*)-**1** reacts with (*R*)-**2a** to form iminium intermediate I, which undergoes deprotonation from the side opposite to the bulky substituent X (X = CAr₂OTMS) of the pyrrolidine ring to afford enamine intermediate (*Z*)-**11** (path A). Then, NFSI attacks (*Z*)-**11** from the side opposite to X to yield (*R*)-**3a**. Although deprotonation may also occur from the same side as X to give (*E*)-**11** (path B), the reaction through path B is consid-

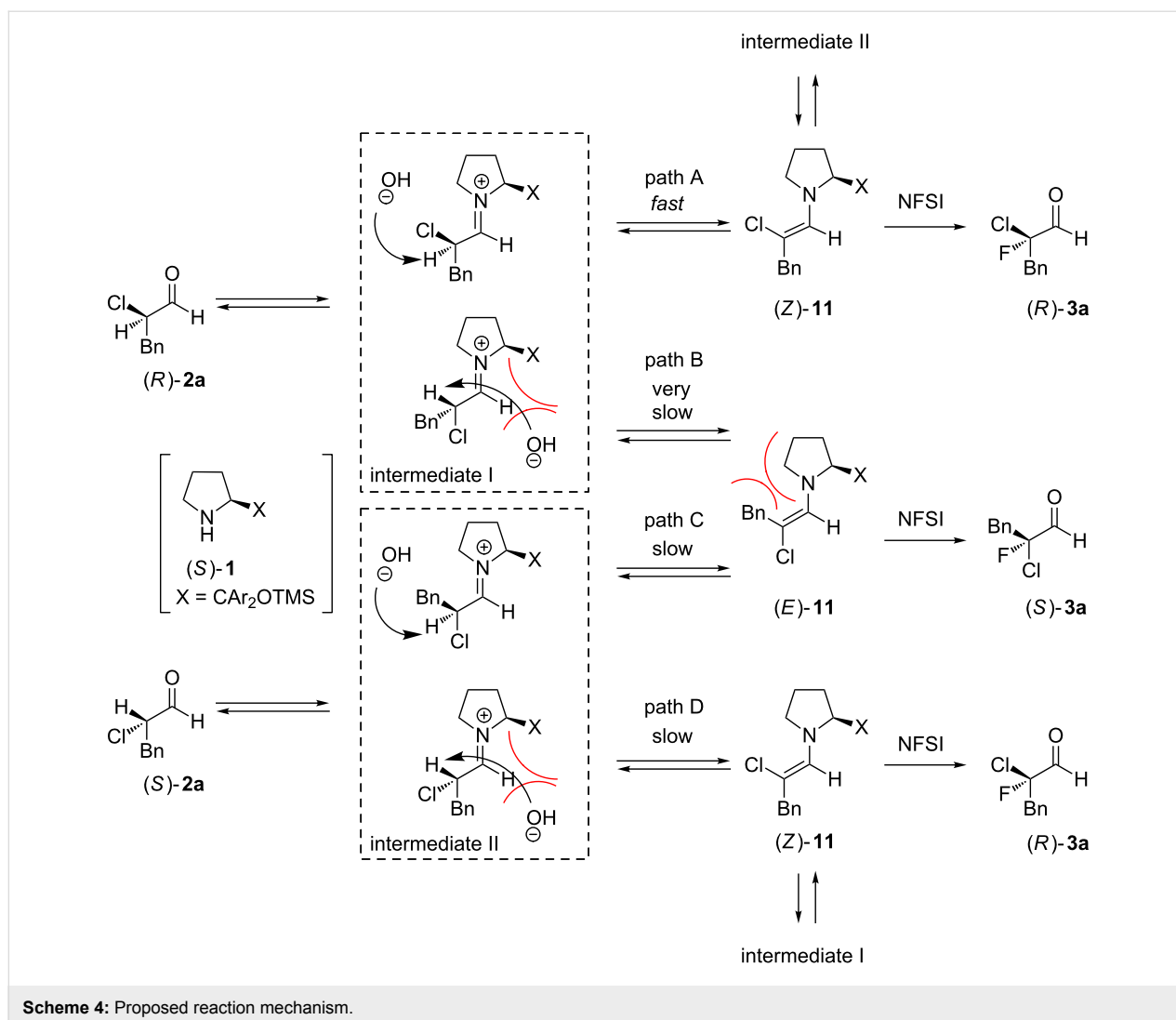

Scheme 4: Proposed reaction mechanism.

ered to be very slow because the steric repulsion between the counter anion (OH^-) and X would prevent deprotonation. Further, the resulting (E) -**11** would be a thermodynamically unfavorable product because of steric repulsion between the methylene group on the pyrrolidine ring and the benzyl substituent on **2a**. Alternatively, (S) -**2a** reacts with (S) -**1** to form iminium intermediate II, which also undergoes deprotonation to form (E) - or (Z) -**11**. In these cases, deprotonation from the side opposite to X (path C) is considered to be slow because the resulting (E) -**11** is a thermodynamically unfavorable form, as described above, and deprotonation from the same side as X (path D) is also slow because of steric repulsion between the counter anion (OH^-) and X . Thus, it is difficult to control the geometry of enamine intermediate **11** when starting from (S) -**2a**, and hence, the enantioselectivity of the fluorination is significantly decreased because the fluorination occurs from the side opposite to X , regardless of the geometry of **11**. For these reasons, high enantioselectivity was observed when **2a** was

employed in excess in the reaction, whereas an excess of NFSI led to poor asymmetric induction. In the former reaction, the major enantiomer of the recovered **5a** was the S -form (Table 1, entries 2 and 3). This result also supports the proposed mechanism.

To test the proposed reaction mechanism, we carried out the fluorination of enantioenriched **2a** (61% ee, R favored) with 2 equiv of NFSI in the presence of each enantiomer of catalyst **1**. As expected from the mechanism, good enantioselectivity was observed when (S) -**1** was employed in the reaction, whereas the reaction proceeded more slowly to yield **4a** with poor enantioselectivity in the presence of (R) -**1** (Scheme 5).

Finally, we were curious to know whether a similar kinetic resolution would be observed in the fluorination of α,α -dialkylaldehydes. We examined the fluorination of racemic α,α -dialkylaldehyde **12** in the presence of catalyst **1** (Scheme 6).

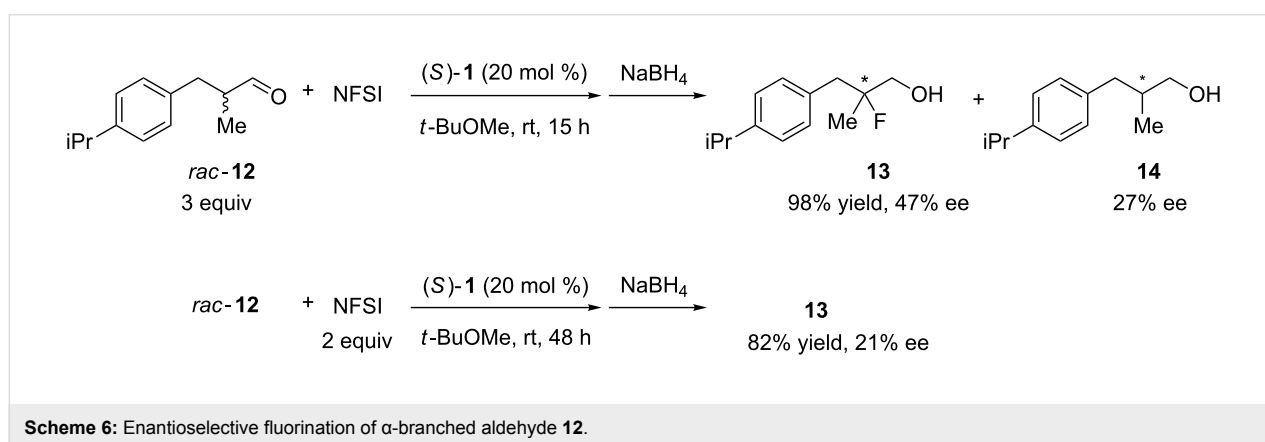
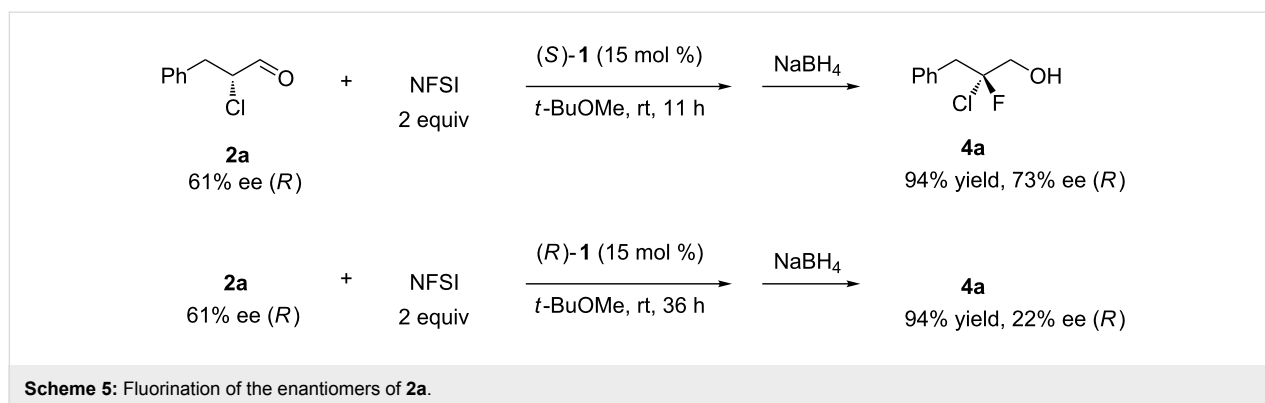

The reaction with 3 equiv of *rac*-**12** based on NFSI afforded the corresponding product **13** in higher enantioselectivity than that obtained in the reaction with 2 equiv of NFSI, along with 27% ee of **14**; however the enantiomeric excess of **13** was not sufficiently high (47% ee). These results suggested that the reaction proceeded by a similar mechanism as shown in Scheme 4.

Conclusion

In conclusion, we succeeded in the highly enantioselective fluorination of α -chloroaldehydes to afford α -chloro- α -fluoroaldehydes mediated by chiral organocatalyst **1**. It was revealed that kinetic resolution of the racemic α -chloroaldehydes occurred during this fluorination reaction, which played an important role in the asymmetric induction.

Experimental

Experiments involving moisture- and/or air-sensitive compounds were performed in oven-dried flasks under an atmosphere of dry argon. All reactions were magnetically stirred and monitored by thin-layer chromatography (TLC) using pre-coated silica gel plates with F₂₅₄ indicator. Visualization was accomplished with UV light (254 nm), or phosphomolybdic acid, potassium permanganate, or anisaldehyde staining.

Column chromatography was performed over silica gel (40–100 μ m). ¹H, ¹³C, and ¹⁹F NMR spectra were acquired on a JEOL JNM-ECX500 spectrometer. Chemical shift values (δ) are reported in ppm (¹H: δ 0.00 for tetramethylsilane; ¹⁹F: δ 0.00 for trichlorofluoromethane; ¹³C: δ 77.0 for residual chloroform). IR spectra were measured on a JASCO FT/IR-230 spectrometer. Elemental analysis was performed with a Yanaco CHN CORDER MT-6. High-performance liquid chromatography (HPLC) analyses were performed with a JASCO PU-1586 with a UV-1575 UV-vis detector using a chiral column. GC analysis was performed with a Shimadzu model 2014 instrument. Optical rotations were measured on a JASCO P-1030 polarimeter.

α -Chloro aldehydes **2** were prepared with *N*-chlorosuccinimide in the presence of organocatalyst according to the procedure reported by Jørgensen [14] and were distilled before use. Racemic forms were synthesized with DL-proline catalyst, and optically active **2a** was synthesized with L-prolinamide catalyst, whose enantiopurity was slightly decreased during the distillation.

We confirmed that the optical purity of fluorinated products **4** did not change even after chromatographic purification using

achiral silica gel and subsequent solvent evaporation. Therefore, we concluded that the enantiomers did not undergo self-disproportionation during the purification process [15–19].

Transformation of **6** to (*R*)-**4a**

Compound **8** was synthesized from **6** (94% de) according to the procedure reported in [9]. A flame-dried flask under argon was charged with **8** (*anti/syn* = 10:1, 0.35 mmol) and 1,2-dichloroethane (2 mL). 1,1'-Thiocarbonyldiimidazole (0.6 mmol) was added to this solution, and the mixture was stirred for 16 h at ambient temperature. The mixture was quenched by adding saturated aqueous NaHCO₃ and extracted with CH₂Cl₂. The organic layer was dried over Na₂SO₄ and concentrated under reduced pressure. The crude mixture was purified by silica gel column chromatography (1:1 hexane/Et₂O) to give **9** in 98% yield (*anti/syn* = 10:1).

9: ¹H NMR (400 MHz, CDCl₃) δ 8.33 (s, 1H), 7.83–7.72 (m, 6H), 7.06 (s, 1H), 6.74 (d, *J* = 21.6 Hz, 1H), 4.87 (td, *J* = 10.8, 4.4 Hz, 1H), 2.01–1.94 (m, 1H), 1.74–1.56 (m, 4H), 1.55–1.36 (m, 2H), 1.18–0.96 (m, 2H), 0.92 (d, *J* = 6.4 Hz, 3H), 0.74 (d, *J* = 7.2 Hz, 3H), 0.52 (d, *J* = 7.2 Hz, 3H); ¹³C NMR (100 MHz, CDCl₃) δ 180.6, 163.6 (d, *J* = 29.4 Hz), 137.1, 131.4, 130.3, 129.9, 129.8, 128.8, 128.6, 117.8, 103.3 (d, *J* = 262.8 Hz), 84.5 (d, *J* = 19.8 Hz), 78.8, 46.8, 40.1, 33.9, 31.5, 26.2, 22.8, 22.0, 20.7, 15.2; ¹⁹F NMR (376 MHz, CDCl₃) δ –132.1 (d, *J* = 21.4 Hz); FTIR (neat) ν_{\max} : 2955, 1762, 1464, 1395, 1288, 1212, 1102, 992, 952, 742, 475 cm⁻¹; anal calcd (%) for C₂₃H₂₈ClFN₂O₃S: C, 59.15; H, 6.04; N, 6.00; found: C, 59.18; H, 5.96; N, 6.40.

A flame-dried flask under argon was charged with **9** (0.22 mmol) and benzene (3.6 mL). Tributyltin hydride (0.45 mmol) was added to this solution, and the mixture was stirred for 30 min at room temperature. The solvent was removed under reduced pressure and the crude mixture was purified by silica gel column chromatography (5:1 hexane/CH₂Cl₂) to give **10** in 42% yield.

10: ¹H NMR (400 MHz, CDCl₃) δ 7.35–7.25 (m, 5H), 4.74 (td, *J* = 10.8, 4.4 Hz, 1H), 3.65 (d, *J* = 6.8 Hz, 1H), 3.59 (d, *J* = 3.2 Hz, 1H), 1.85–1.76 (m, 2H), 1.72–1.63 (m, 2H), 1.50–1.41 (m, 2H), 1.37–1.19 (m, 1H), 1.09–0.98 (m, 1H), 0.95–0.91 (m, 1H), 0.89 (d, *J* = 2.4 Hz, 3H), 0.87 (dd, *J* = 3.2 Hz, 3H), 0.74 (dd, *J* = 7.2 Hz, 3H); ¹³C NMR (100 MHz, CDCl₃) δ 165.3 (d, *J* = 27.4 Hz), 132.3, 130.7, 130.6, 128.5, 127.9, 106.1 (d, *J* = 257.9 Hz), 77.9, 46.8, 40.0, 34.0, 31.4, 26.1, 23.3, 22.0, 20.8, 16.1; ¹⁹F NMR (376 MHz, CDCl₃) δ –116.6 (dd, *J* = 22.9, 19.6 Hz); FTIR (neat) ν_{\max} : 2954, 1754, 1458, 1282, 1216, 1145, 1043, 952, 704, 624, 471 cm⁻¹; anal calcd (%) for C₁₉H₂₆ClFO₂: C, 66.95; H, 7.69; found: C, 67.02; H, 7.96.

A flame-dried flask under argon was charged with **10** (0.07 mmol) and Et₂O (0.2 mL). LiAlH₄ (0.11 mmol) was added to this solution at –78 °C, and the mixture was stirred for 1 h at room temperature. The reaction mixture was quenched with saturated aqueous NH₄Cl and the mixture was extracted with Et₂O. The organic layer was dried over Na₂SO₄ and concentrated under reduced pressure. The crude mixture was purified by silica gel column chromatography (5:1 hexane/EtOAc) to give (*R*)-**4a** in 74% yield, with an enantiomeric purity of 94% ee.

4a: [α]_D = –2.8 (*c* 1.5, CHCl₃). HPLC (99:1 hexane/2-propanol; 1 mL/min; using a CHIRALPAK IC column (0.46 cm Ø × 25 cm)): 11.4 min (major) and 11.9 min (minor). These analytical data were identical to those of **4a** synthesized from **2a** with (*S*)-**1**.

General procedure for the asymmetric fluorination of α-chloroaldehydes **2**

To a solution of α-chloroaldehyde **2** (1.5 mmol) in *t*-BuOMe (2 mL) was added catalyst **1** (0.05 mmol) and NFSI (0.5 mmol). The reaction mixture was stirred at room temperature for the time given in Table 1 and then poured into MeOH/CH₂Cl₂ (1:4, 5 mL) at 0 °C. To this solution, NaBH₄ (5 mmol) was added, and the mixture was stirred at room temperature for 1 h. The reaction was quenched with saturated aqueous NH₄Cl, and the mixture was extracted with Et₂O. The organic layer was dried over Na₂SO₄, concentrated, and chromatographed on silica gel to give **4**, along with monochloro alcohol **5**.

The results of all spectroscopic analyses of compounds **4a**, **4b**, **4f**, **4g**, and **5a–5f** were identical to those described in our previous report [8] and in references [20,21]. Absolute configuration of **5a–5c** was confirmed by comparing their optical rotation to that reported in the above-mentioned literature [20].

(*R*)-2-Chloro-2-fluoro-3-phenylpropan-1-ol (**4a**, 87% ee):

¹H NMR (500 MHz, CDCl₃) δ 7.35–7.30 (m, 5H), 3.88–3.71 (m, 2H), 3.46 (dd, *J* = 32.3, 15.0 Hz, 2H), 2.15 (br, 1H); ¹³C NMR (125 MHz, CDCl₃) δ 133.3 (d, *J* = 3.8 Hz), 130.7, 128.4, 127.6, 114.8 (d, *J* = 247 Hz), 67.2 (d, *J* = 26.4 Hz), 44.6 (d, *J* = 21.4 Hz); ¹⁹F NMR (470 MHz, CDCl₃) δ –114.2 (m); [α]_D = –2.7 (*c* 1.5, CHCl₃). The enantiopurity was determined by HPLC (99:1 hexane/2-propanol; 1 mL/min; using a CHIRALPAK IC column (0.46 cm Ø × 25 cm)): 11.4 min (major) and 11.9 min (minor).

2-Chloro-2-fluorooctan-1-ol (**4b**, 80% ee):

¹H NMR (500 MHz, CDCl₃) δ 3.91–3.78 (m, 2H), 2.14–2.05 (m, 3H), 1.59–1.54 (m, 2H), 1.37–1.29 (m, 6H), 0.90 (t, *J* = 7.0 Hz, 3H);

^{13}C NMR (125 MHz, CDCl_3) δ 116.1 (d, $J = 245$ Hz), 68.3 (d, $J = 26.4$ Hz), 38.5 (d, $J = 21.3$ Hz), 31.5, 28.9, 23.3 (d, $J = 3.8$ Hz), 22.5, 14.0; ^{19}F NMR (470 MHz, CDCl_3) δ -113.9 (br); $[\alpha]_{\text{D}} = +2.0$ (c 0.5, CHCl_3). The enantiopurity was determined by GC (100–150 °C, 3 °C/min; using a Chiral DEX B-DM column): 12.4 min (major) and 13.3 min (minor).

2-Chloro-2-fluoro-5-(methoxymethoxy)pentan-1-ol (4c, 78% ee): ^1H NMR (500 MHz, CDCl_3) δ 4.63 (s, 2H), 3.99–3.79 (m, 2H), 3.66–3.55 (m, 2H), 3.37 (s, 3H), 2.40–2.12 (m, 3H), 2.01–1.82 (m, 2H); ^{13}C NMR (125 MHz, CDCl_3) δ 115.8 (d, $J = 245$ Hz), 96.4, 68.4 (d, $J = 26.4$ Hz), 66.8, 55.3, 35.4 (d, $J = 21.6$ Hz), 23.9 (d, $J = 4.8$ Hz); ^{19}F NMR (470 MHz, CDCl_3) δ -114.3 (m); $[\alpha]_{\text{D}}^{22} = +4.6$ (c 0.16, CHCl_3); anal calcd (%) for $\text{C}_7\text{H}_{14}\text{ClFO}_3$: C, 41.91; H, 7.03; Cl, 17.67; F, 9.47; O, 23.92; found: C, 44.91; H, 7.51. The enantiopurity was determined after conversion into the corresponding 2-naphthoate **15c**.

A flame-dried flask under argon was charged with **4c** (0.10 mmol) and CH_2Cl_2 (1.0 mL). Triethylamine (0.20 mmol), 2-naphthoyl chloride (0.15 mmol), and 4-dimethylaminopyridine (0.01 mmol) were added to this solution, and the mixture was stirred for 2 h at 0 °C. The mixture was diluted by saturated aqueous NaHCO_3 , and extracted with CH_2Cl_2 . The organic layer was dried over Na_2SO_4 and concentrated under reduced pressure. The crude mixture was purified by silica gel column chromatography (hexane/ethyl acetate 5:1) to give the desired 2-naphthoate **15c** in 82% yield.

2-Chloro-2-fluoro-5-(methoxymethoxy)pentyl 2-naphthoate (15c, 78% ee): ^1H NMR (400 MHz, CDCl_3) δ 8.65 (s, 1H), 8.08 (d, $J = 10.4$ Hz, 1H), 7.98 (d, $J = 8.4$ Hz, 1H), 7.93–7.86 (m, 2H), 7.67–7.53 (m, 2H), 4.83–4.66 (m, 2H), 4.61 (s, 2H), 3.62 (t, $J = 5.80$ Hz, 2H), 3.34 (s, 3H), 2.49–2.19 (m, 2H), 2.11–1.88 (m, 2H); ^{13}C NMR (100 MHz, CDCl_3) δ 165.6, 135.8, 132.4, 131.6, 129.4, 128.6, 128.4, 127.8, 126.8, 126.3, 125.2, 112.8 (d, $J = 247$ Hz), 96.4, 68.1 (d, $J = 26.8$ Hz), 66.6, 55.2, 36.2 (d, $J = 22.0$ Hz), 23.9 (d, $J = 3.83$ Hz); ^{19}F NMR (470 MHz, CDCl_3) δ -111.7 (m); $[\alpha]_{\text{D}}^{22} = +7.5$ (c 0.36, CHCl_3); anal calcd (%) for $\text{C}_{18}\text{H}_{20}\text{ClFO}_4$: C, 60.93; H, 5.68; Cl, 9.99; F, 5.35; O, 18.04; found: C, 60.95; H, 5.85. The enantiopurity was determined by HPLC (50:1 hexane/2-propanol; 0.5 mL/min; using a CHIRALPAK ID column (0.46 cm \varnothing \times 25 cm)): 25.1 min (major) and 30.5 min (minor).

Ethyl 5-chloro-5-fluoro-6-hydroxyhexanoate (4d, 80% ee): ^1H NMR (500 MHz, CDCl_3) δ 4.14 (q, $J = 7.3$ Hz, 2H), 3.94–3.80 (m, 2H), 2.58 (s, 1H), 2.44–2.34 (m, 2H), 2.28–2.07 (m, 2H), 1.95–1.86 (m, 2H), 1.26 (t, $J = 7.3$ Hz, 3H); ^{13}C NMR (125 MHz, CDCl_3) δ 173.1, 115.4 (d, $J = 246.5$ Hz), 68.1 (d, $J = 26.5$ Hz), 60.6, 37.4 (d, $J = 22.8$ Hz), 33.3, 18.9 (d, $J = 4.8$

Hz), 14.2; ^{19}F NMR (470 MHz, CDCl_3) δ -114.0 (m); $[\alpha]_{\text{D}}^{13} = -1.48$ (c 1.1, CHCl_3); anal calcd (%) for $\text{C}_8\text{H}_{14}\text{ClFO}_3$: C, 45.19; H, 6.64; found: C, 44.65; H, 6.67. The enantiopurity was determined after conversion into the corresponding 2-naphthoate **15d** by a procedure similar to that employed for the synthesis of **15c**. The crude mixture was purified by silica gel column chromatography (hexane/EtOAc = 10:1) to give 81% yield of **15d**.

2-Chloro-6-ethoxy-2-fluoro-6-oxohexyl 2-naphthoate (15d, 80% ee): ^1H NMR (500 MHz, CDCl_3) δ 8.65 (s, 1H), 8.07 (d, $J = 8.8$ Hz, 1H), 7.99 (d, $J = 8.0$ Hz, 1H), 7.92–7.89 (m, 2H), 7.64–7.55 (m, 2H), 4.79–4.66 (m, 2H), 4.13 (q, $J = 7.0$ Hz, 2H), 2.48–2.38 (m, 2H), 2.37–2.17 (m, 2H), 2.09–1.95 (m, 2H), 1.24 (t, $J = 7.0$ Hz, 3H); ^{13}C NMR (125 MHz, CDCl_3) δ 172.7, 165.6, 135.7, 132.4, 131.6, 129.5, 128.6, 128.4, 127.8, 126.8, 126.2, 125.1, 112.5 (d, $J = 247.6$ Hz), 67.9 (d, $J = 27.6$ Hz), 60.5, 38.4 (d, $J = 22.8$ Hz), 33.4, 18.9 (d, $J = 4.8$ Hz), 14.2; ^{19}F NMR (470 MHz, CDCl_3) δ -111.8 (m); $[\alpha]_{\text{D}}^{21} = +7.1$ (c 0.31, CHCl_3); anal calcd (%) for $\text{C}_{19}\text{H}_{20}\text{ClFO}_4$: C, 62.21; H, 5.50; found: C, 62.92; H, 6.07. The enantiopurity was determined by HPLC (50:1 hexane/2-propanol; 1.0 mL/min; using a CHIRALPAK IB-3 column (0.46 cm \varnothing \times 25 cm)): 19.5 min (minor) and 24.9 min (major).

2-Chloro-2-cyclohexyl-2-fluoroethan-1-ol (4e, 96% ee): ^1H NMR (500 MHz, CDCl_3) δ 4.02–3.83 (m, 2H), 2.19–2.08 (m, 1H), 1.98–1.92 (m, 1H), 1.89–1.78 (m, 3H), 1.74–1.66 (m, 1H), 1.39–1.11 (m, 6H); ^{13}C NMR (125 MHz, CDCl_3) δ 119.0 (d, $J = 247$ Hz), 66.8 (d, $J = 26.4$ Hz), 44.5 (d, $J = 20.4$ Hz), 27.3 (d, $J = 6.0$ Hz), 26.1 (d, $J = 3.6$ Hz), 25.9, 25.7, 25.6; ^{19}F NMR (470 MHz, CDCl_3) δ -117.8 (m); $[\alpha]_{\text{D}}^{22} = -6.2$ (c 0.64, CHCl_3); anal calcd (%) for $\text{C}_8\text{H}_{14}\text{ClFO}$: C, 53.19; H, 7.81; Cl, 19.62; F, 10.52; O, 8.86; found: C, 52.52; H, 7.88. The enantiopurity was determined after conversion into the corresponding 2-naphthoate **15e** by a procedure similar to that employed for the synthesis of **15c**. The crude mixture was purified by silica gel column chromatography (hexane/ethyl acetate = 20:1) to give 81% yield of **15e**.

2-Chloro-2-cyclohexyl-2-fluoroethyl 2-naphthoate (15e, 96% ee): ^1H NMR (500 MHz, CDCl_3) δ 8.65 (s, 1H), 8.08 (d, $J = 10.32$ Hz, 1H), 7.99 (d, $J = 8.41$ Hz, 1H), 7.94–7.87 (m, 2H), 7.66–7.54 (m, 2H), 4.75 (br d, $J = 17.5$ Hz, 1H), 4.75 (br d, $J = 19.0$ Hz, 1H), 2.25–2.16 (m, 1H), 2.09–2.00 (m, 1H), 1.96–1.80 (m, 3H), 1.76–1.66 (m, 1H), 1.49–1.35 (m, 1H), 1.36–1.15 (m, 4H); ^{13}C NMR (100 MHz, CDCl_3) δ 165.6, 135.7, 132.4, 131.6, 129.5, 128.6, 128.4, 127.8, 126.8, 126.5, 125.2, 116.0 (d, $J = 248.2$ Hz), 66.7 (d, $J = 25.9$ Hz), 45.4 (d, $J = 20.1$ Hz), 27.4 (d, $J = 5.8$ Hz), 26.1 (d, $J = 2.8$ Hz), 25.8, 25.7, 25.6; ^{19}F NMR (470 MHz, CDCl_3) δ -114.3 (m); $[\alpha]_{\text{D}}^{24} = -13.7$ (0.36,

CHCl₃); anal. calcd (%) for C₁₉H₂₀ClFO₂: C, 68.16; H, 6.02; Cl, 10.59; F, 5.67; O, 9.56; found: C, 68.03; H, 5.98. The enantiopurity was determined by HPLC (200:1 hexane/2-propanol; 0.5 mL/min; using a CHIRALCEL OJ-H column (0.46 cm Ø × 25 cm)): 22.5 min (major) and 25.4 min (minor).

2-Chloro-2-fluoro-2-phenylethanol (4f, 90% ee): ¹H NMR (500 MHz, CDCl₃) δ 7.59–7.53 (m, 2H), 7.46–7.40 (m, 3H), 4.15–4.04 (m, 2H), 2.15 (t, *J* = 7.3 Hz, 1H); ¹³C NMR (125 MHz, CDCl₃) δ 137.7 (d, *J* = 22.6 Hz), 129.8, 128.6, 125.3 (d, *J* = 7.5 Hz), 112.9 (d, *J* = 247 Hz), 70.2 (d, *J* = 26.4 Hz); ¹⁹F NMR (470 MHz, CDCl₃) δ –118.2 (t, *J* = 18.8 Hz); [α]_D²⁵ = –76.5 (*c* 0.6, CHCl₃). The enantiopurity was determined by HPLC (99:1 hexane/2-propanol; 1 mL/min; using a CHIRALPAK IC column (0.46 cm Ø × 25 cm)): 19.1 min (major) and 21.1 min (minor).

2-Chloro-2-fluoro-3,3-dimethylbutan-1-ol (4g) and 2-Chloro-3,3-dimethylbutan-1-ol (5g): **4g** and **5g** were inseparable by column chromatography. Therefore, isolation and determination of their enantiopurity were performed after the conversion into the corresponding 2-naphthoates **15g** and **16g** by a procedure similar to that employed for the synthesis of **15c**. The crude mixture was purified by silica gel column chromatography (hexane/CH₂Cl₂ = 3:1) to give 87% yield of **15g**, along with 80% yield of **16g**.

2-Chloro-2-fluoro-3,3-dimethylbutyl 2-naphthoate (15g, 99% ee): ¹H NMR (400 MHz, CDCl₃) δ 8.68 (s, 1H), 8.12 (d, *J* = 8.9 Hz, 1H), 7.98 (d, *J* = 8.2 Hz, 1H), 7.92–7.88 (m, 2H), 7.63–7.54 (m, 2H), 4.89–4.78 (m, 2H), 1.26 (s, 9H); ¹³C NMR (125 MHz, CDCl₃) δ 166.0, 135.7, 132.4, 131.6, 129.5, 128.5, 128.3, 127.8, 126.7, 126.6, 125.2, 119.1 (d, *J* = 251.9 Hz), 66.0 (d, *J* = 25.2 Hz), 40.8 (d, *J* = 20.4 Hz), 25.5 (d, *J* = 3.6 Hz); ¹⁹F NMR (470 MHz, CDCl₃) δ –120.3 (m); [α]_D²⁰ = –22.5 (*c* 1.4, CHCl₃); anal. calcd (%) for C₁₇H₁₈ClFO₂: C, 66.13; H, 5.88; found: C, 65.88; H, 6.10. The enantiopurity was determined by HPLC (200:1 hexane/2-propanol; 1.0 mL/min; using a CHIRALPAK IB-3 column (0.46 cm Ø × 25 cm)): 9.7 min (minor) and 14.0 min (major).

2-Chloro-3,3-dimethylbutyl 2-naphthoate (16g, 29% ee): ¹H NMR (500 MHz, CDCl₃) δ 8.65 (s, 1H), 8.09 (d, *J* = 8.6 Hz, 1H), 7.98 (d, *J* = 7.6 Hz, 1H), 7.91–7.89 (m, 2H), 7.62–7.55 (m, 2H), 4.81 (dd, *J* = 3.1, 11.9 Hz, 1H), 4.45 (dd, *J* = 8.8, 11.9 Hz, 1H), 4.11 (dd, *J* = 3.1, 8.8 Hz, 1H), 1.16 (s, 9H); ¹³C NMR (125 MHz, CDCl₃) δ 166.5, 135.6, 132.4, 131.3, 129.4, 128.3, 128.2, 127.7, 127.0, 126.7, 125.2, 70.1, 66.4, 35.2, 27.0; [α]_D²⁰ = +16.2 (*c* 1.3, CHCl₃); anal. calcd (%) for C₁₇H₁₉ClO₂: C, 70.22; H, 6.59; found: C, 69.92; H, 6.88. The enantiopurity was determined by HPLC (200:1 hexane/2-propanol; 1.0 mL/min;

using a CHIRALPAK AS-H column (0.46 cm Ø × 25 cm)): 7.2 min (major) and 8.3 min (minor).

2-Fluoro-3-(4-isopropylphenyl)-2-methylpropan-1-ol (13, 47% ee) [7]: ¹H NMR (500 MHz, CDCl₃) δ 7.16 (s, 4H), 3.61–3.56 (m, 2H), 2.96 (br d, *J* = 16.5 Hz, 1H), 2.96 (br d, *J* = 20.5 Hz, 1H), 2.91–2.85 (m, 1H), 1.82 (br s, 1H), 1.27 (d, *J* = 21.8 Hz, 3H), 1.24 (d, *J* = 6.9 Hz, 6H); ¹³C NMR (125 MHz, CDCl₃) δ 147.3, 133.2 (d, *J* = 4.8 Hz), 130.3, 126.3, 97.4 (d, *J* = 170 Hz), 67.5 (d, *J* = 22.8 Hz), 41.9 (d, *J* = 22.8 Hz), 33.7, 24.0, 20.9 (d, *J* = 22.8); ¹⁹F NMR (470 MHz, CDCl₃) δ –154.7 (m); [α]_D²⁵ = –7.0 (*c* 0.60, CHCl₃); The enantiopurity was determined by HPLC (99:1 hexane/2-propanol; 1 mL/min; using a CHIRALCEL OJ column (0.46 cm Ø × 25 cm)): 17.4 min (major) and 21.8 min (minor).

3-(4-Isopropylphenyl)-2-methylpropan-1-ol (14, 27% ee) [22]: ¹H NMR (500 MHz, CDCl₃) δ 7.15 (d, *J* = 8.0 Hz, 2H), 7.10 (d, *J* = 8.0 Hz, 2H), 3.54 (dd, 5.0, 5.7 Hz, 1H), 3.47 (dd, *J* = 4.6, 6.1 Hz, 1H), 2.88 (m, 1H), 2.71 (dd, *J* = 6.5, 6.9 Hz, 1H), 2.41 (dd, *J* = 5.3, 8.1 Hz, 1H), 1.93 (m, 1H), 1.24 (d, *J* = 6.9 Hz, 6H), 0.92 (d, *J* = 6.5 Hz, 3H); ¹³C NMR (125 MHz, CDCl₃) δ 146.4, 137.8, 129.0, 126.3, 67.8, 39.3, 37.8, 33.7, 24.1, 16.6; [α]_D²⁵ = –2.3 (*c* 0.15, CHCl₃); The enantiopurity was determined by HPLC (99:1 hexane/2-propanol; 1 mL/min; using a CHIRALPAK IC-3 column (0.46 cm Ø × 25 cm)): 17.6 min (minor) and 19.9 min (major).

Acknowledgements

This study was supported by the Tatematsu Foundation and a Grant-in-Aid for Scientific Research (C) (25410113) from Japan Society for the Promotion of Science.

References

- Ojima, I., Ed. *Fluorine in Medicinal Chemistry and Chemical Biology*; John Wiley & Sons: Chichester, 2009. doi:10.1002/9781444312096
- Bégué, J.-P.; Bonnet-Delphon, D. *Bioorganic and Medicinal Chemistry of Fluorine*; John Wiley & Sons: Hoboken, 2008. doi:10.1002/9780470281895
- Marigo, M.; Fielenbach, D.; Braunton, A.; Kjærsgaard, A.; Jørgensen, K. A. *Angew. Chem., Int. Ed.* **2005**, *44*, 3703. doi:10.1002/anie.200500395
- Beeson, T. D.; MacMillan, D. W. C. *J. Am. Chem. Soc.* **2005**, *127*, 8826. doi:10.1021/ja051805f
- Steiner, D. D.; Mase, N.; Barbas, C. F., III. *Angew. Chem., Int. Ed.* **2005**, *44*, 3706. doi:10.1002/anie.200500571
- Enders, D.; Hüttl, M. R. M. *Synlett* **2005**, 991. doi:10.1055/s-2005-864813
- Brandes, S.; Niess, B.; Bella, M.; Prieto, A.; Overgaard, J.; Jørgensen, K. A. *Chem.–Eur. J.* **2006**, *12*, 6039. doi:10.1002/chem.200600495
- Shibatomi, K.; Yamamoto, H. *Angew. Chem., Int. Ed.* **2008**, *47*, 5796. doi:10.1002/anie.200801682

9. Shibatomi, K.; Narayama, A.; Soga, Y.; Muto, T.; Iwasa, S. *Org. Lett.* **2011**, *13*, 2944. doi:10.1021/ol201007e
10. Shibatomi, K.; Muto, T.; Smikawa, Y.; Narayama, A.; Iwasa, S. *Synlett* **2009**, 241. doi:10.1055/s-0028-1087675
11. Shibatomi, K.; Soga, Y.; Narayama, A.; Fujisawa, I.; Iwasa, S. *J. Am. Chem. Soc.* **2012**, *134*, 9836. doi:10.1021/ja304806j
12. Narayama, A.; Shibatomi, K.; Soga, Y.; Muto, T.; Iwasa, S. *Synlett* **2013**, *24*, 375. doi:10.1055/s-0032-1318027
13. Barton, D. H. R.; McCombie, S. W. *J. Chem. Soc., Perkin Trans. 1* **1975**, 1574. doi:10.1039/p19750001574
14. Halland, N.; Braunton, A.; Bachmann, S.; Marigo, M.; Jørgensen, K. A. *J. Am. Chem. Soc.* **2004**, *126*, 4790. doi:10.1021/ja049231m
15. Soloshonok, V. A.; Roussel, C.; Kitagawa, O.; Sorochinsky, A. E. *Chem. Soc. Rev.* **2012**, *41*, 4180. doi:10.1039/c2cs35006h
16. Han, J.; Nelson, D. J.; Sorochinsky, A. E.; Soloshonok, V. A. *Curr. Org. Synth.* **2011**, *8*, 310. doi:10.2174/157017911794697303
17. Ueki, H.; Yasumoto, M.; Soloshonok, V. A. *Tetrahedron: Asymmetry* **2010**, *21*, 1396. doi:10.1016/j.tetasy.2010.04.040
18. Soloshonok, V. A.; Ueki, H.; Yasumoto, M.; Mekala, S.; Hirschi, J. S.; Singleton, D. A. *J. Am. Chem. Soc.* **2007**, *129*, 12112. doi:10.1021/ja065603a
19. Soloshonok, V. A. *Angew. Chem., Int. Ed.* **2006**, *45*, 766. doi:10.1002/anie.200503373
20. Amatore, M.; Beeson, T. D.; Brown, S. P.; MacMillan, D. W. C. *Angew. Chem., Int. Ed.* **2009**, *48*, 5121. doi:10.1002/anie.200901855
21. Lutje Spelberg, J. H.; van Hylckama Vlieg, J. E. T.; Bosma, T.; Kellogg, R. M.; Janssen, D. B. *Tetrahedron: Asymmetry* **1999**, *10*, 2863. doi:10.1016/S0957-4166(99)00308-0
22. Rosini, G.; Paolucci, C.; Boschi, F.; Marotta, E.; Righi, P.; Tozzi, F. *Green Chem.* **2010**, *12*, 1747. doi:10.1039/c0gc00013b

License and Terms

This is an Open Access article under the terms of the Creative Commons Attribution License (<http://creativecommons.org/licenses/by/2.0>), which permits unrestricted use, distribution, and reproduction in any medium, provided the original work is properly cited.

The license is subject to the *Beilstein Journal of Organic Chemistry* terms and conditions: (<http://www.beilstein-journals.org/bjoc>)

The definitive version of this article is the electronic one which can be found at:
doi:10.3762/bjoc.10.30

Deoxygenative *gem*-difluoroolefination of carbonyl compounds with (chlorodifluoromethyl)trimethylsilane and triphenylphosphine

Fei Wang, Lingchun Li, Chuanfa Ni and Jinbo Hu*

Full Research Paper

Open Access

Address:

Key Laboratory of Organofluorine Chemistry, Shanghai Institute of Organic Chemistry, Chinese Academy of Sciences, 345 Ling-Ling Road, Shanghai 200032, China

Email:

Jinbo Hu* - jinbohu@sioc.ac.cn

* Corresponding author

Keywords:

(chlorodifluoromethyl)trimethylsilane; difluorocarbene; *gem*-difluoroolefin; organo-fluorine; Wittig reaction; ylide

Beilstein J. Org. Chem. **2014**, *10*, 344–351.

doi:10.3762/bjoc.10.32

Received: 16 September 2013

Accepted: 14 January 2014

Published: 06 February 2014

This article is part of the Thematic Series "Organo-fluorine chemistry III".

Guest Editor: D. O'Hagan

© 2014 Wang et al; licensee Beilstein-Institut.

License and terms: see end of document.

Abstract

Background: 1,1-Difluoroalkenes cannot only be used as valuable precursors for organic synthesis, but also act as bioisosteres for enzyme inhibitors. Among various methods for their preparation, the carbonyl olefination with difluoromethylene phosphonium ylide represents one of the most straightforward methods.

Results: The combination of (chlorodifluoromethyl)trimethylsilane (TMSCF₂Cl) and triphenylphosphine (PPh₃) can be used for the synthesis of *gem*-difluoroolefins from carbonyl compounds. Comparative experiments demonstrate that TMSCF₂Cl is superior to (bromodifluoromethyl)trimethylsilane (TMSCF₂Br) and (trifluoromethyl)trimethylsilane (TMSCF₃) in this reaction.

Conclusion: Similar to many other Wittig-type *gem*-difluoroolefination reactions in the presence of PPh₃, the reaction of TMSCF₂Cl with aldehydes and activated ketones is effective.

Introduction

The synthesis and application of selectively fluorinated organic molecules have attracted much interest from both organic chemists and biochemists because fluorine can endow these molecules with unique chemical, biological and physical properties [1-3]. 1,1-Difluoroalkenes have been frequently used in the design of potential enzyme inhibitors [4-6], since difluoro-

methylene functionality (CF₂) is known to be isosteric and isopolar to an oxygen atom [7-9], and the *gem*-difluorovinyl functionality is believed to be a bioisostere for a carbonyl group [10]. More commonly, 1,1-difluoroalkenes, which are highly electrophilic towards many nucleophiles at the terminal difluoromethylene carbon [11], are used as valuable precursors

of di- and trifluoromethyl compounds [10,12], monofluoroalkenes [13], monofluorinated heterocycles [14,15], carboxylic acids and esters [16]. Consequently, these relevant applications of 1,1-difluoroalkenes have led to many efforts to develop *gem*-difluoroolefination methods including β -elimination of functionalized difluoromethyl compounds, transition metal catalysed coupling reactions with *gem*-difluorovinyl reagents, and deoxygenative *gem*-difluoroolefination of carbonyl compounds [17,18]. Among these methods, the latter one has been studied with several named reactions, for example Wittig, Horner–Wadsworth–Emmons, and Julia–Kocienski reactions.

In the Wittig *gem*-difluoroolefination, the reaction is believed to proceed via an undetected difluoromethylene phosphonium ylide, which can be generated in situ either by the transformation of a difluorinated phosphonium salt or by the reaction between difluorocarbene (:CF₂) and a phosphine (Scheme 1) [19–26]. In 1964, Fuqua and co-workers first reported the difluoromethylenation of aldehydes by using ClCF₂CO₂Na/PPh₃ [19]. In 1967, Burton and Herkes suggested that the ylide intermediate involved in the olefination process was more likely to be formed by the decarboxylation of a difluorinated phosphonium salt rather than the combination of :CF₂ and a phosphine (Scheme 1, reaction 1) [20]. Their suggestion is based on the accelerating effect of PPh₃ on the thermal decomposition of ClCF₂CO₂Na and the unsuccessful capture of :CF₂ with an

alkene or alcohol during the olefination reaction [20]. Very recently, the successful preparation of (triphenylphosphonio)difluoroacetate (Ph₃P⁺CF₂CO₂[−]) and its application in carbonyl *gem*-difluoroolefination by Xiao and co-workers [21] finally confirmed the mechanism proposed by Burton and others [19,20]. Burton and co-workers also developed another difluorocarbene-free approach using a 1:2 mixture of CF₂Br₂ and PPh₃ or P(NMe₂)₃ to prepare the ylide intermediate (Scheme 1, reaction 2) [22,23]. Although the difluorocarbene/phosphine procedure for Wittig olefination has been put forward by Fuqua et al. as early as 1964 [19], the formation of difluoromethylene phosphonium ylide in such a way is quite rare [24–26]. Established examples include using bis(trifluoromethyl)mercury (Hg(CF₃)₂) under the promotion of NaI (Scheme 1, reaction 3) [24] and using methyl 2,2-difluoro-2-(fluorosulfonyl)acetate (MDFA) under the promotion of KI (Scheme 1, reaction 4) [25].

Our group has focused on the development and application of new difluorocarbene reagents [27–34]. The Prakash group and we have identified that (halodifluoromethyl)trimethylsilanes (TMSCF₂X, X = F, Cl, and Br) could serve as difluorocarbene sources under the activation of proper halide initiators or alkaline bases (Scheme 2) [31–34]. Recently, we have developed a relatively environmentally benign method to prepare TMSCF₂Br, which can be used as a general carbene source for

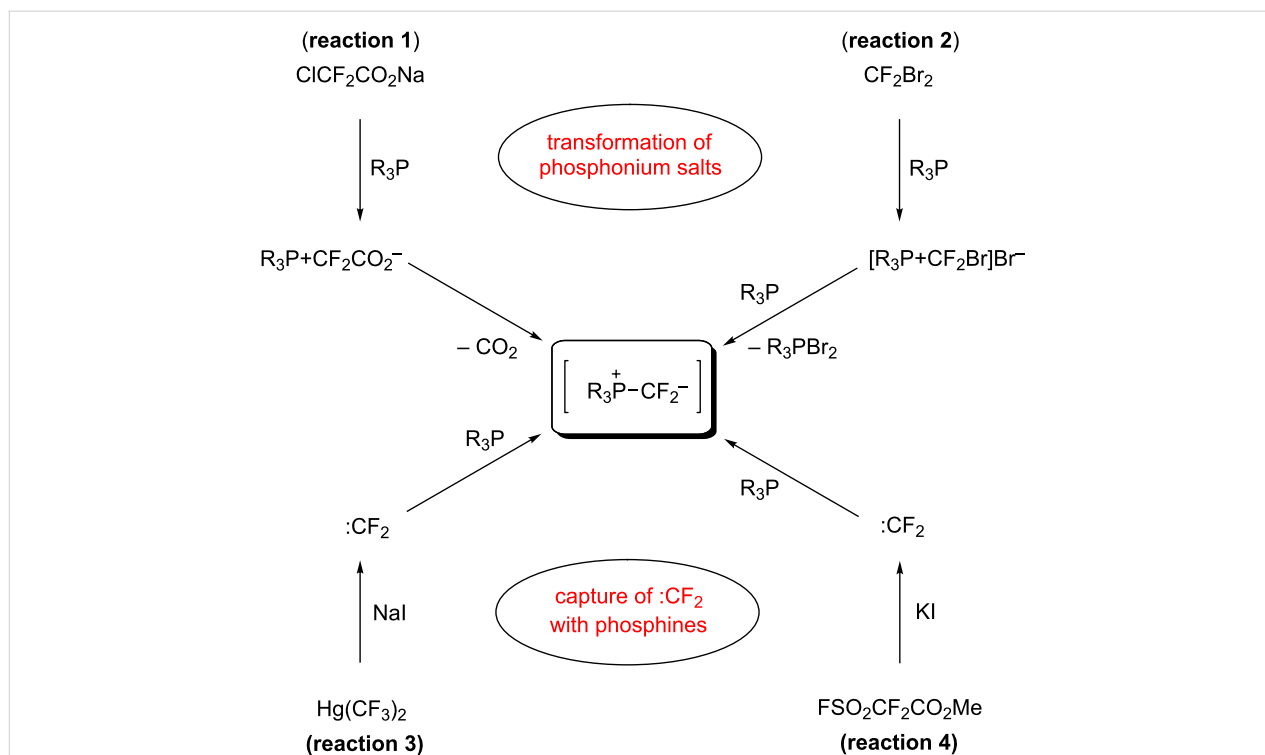

Scheme 1: Various procedures for the generation of difluoromethylene phosphonium ylide [19–25].

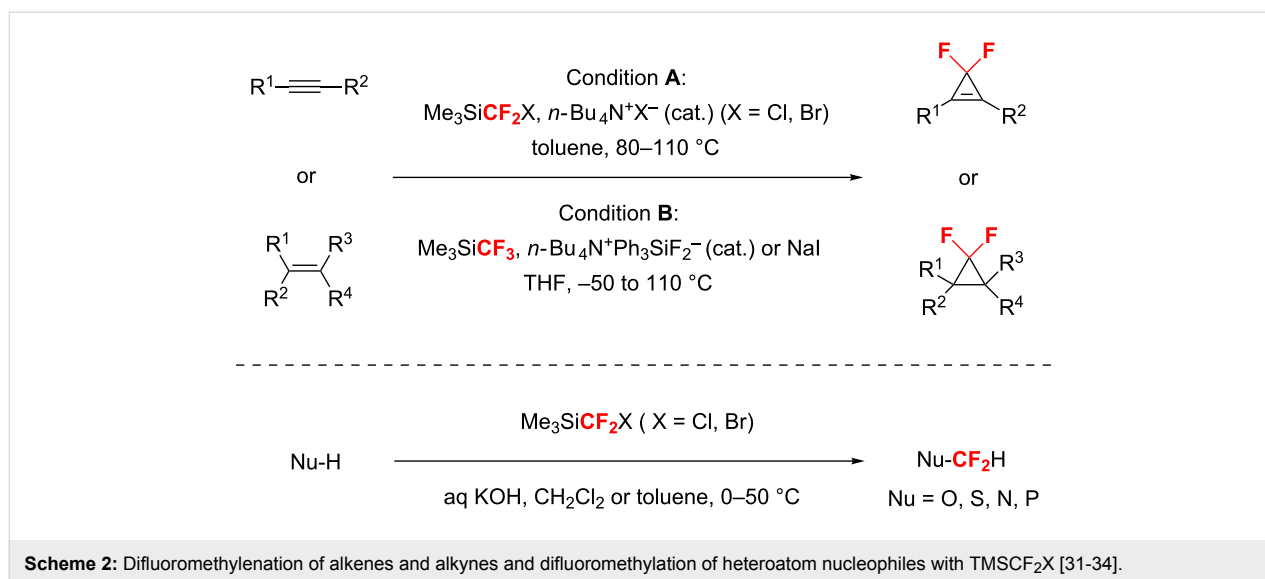

the difluoromethylenation of alkynes and alkenes and difluoromethylation of heteroatom nucleophiles [34]. In this paper, the novel preparation of TMSCF₂Cl from TMSCF₂Br and the application of the former in deoxygenative *gem*-difluoroolefination of carbonyl compounds via Wittig-type reaction are reported.

Results and Discussion

(Halodifluoromethyl)trimethylsilanes including TMSCF₃ (Ruppert–Prakash reagent), TMSCF₂Cl, and TMSCF₂Br are initially prepared by reductive silylation of ozone-depleting-substances bromotrifluoromethane (CF₃Br) [35], bromochlorodifluoromethane (CF₂BrCl) [36,37], and dibromodifluoromethane (CF₂Br₂) [36,37] with chlorotrimethylsilane (TMSCl). In recent years, Prakash and co-workers have discovered two Freon-free methods for the synthesis of TMSCF₃ from fluoroform (CF₃H), which paved the way for the synthetic applications of TMSCF₃ [38,39]. Moreover, the preparation of TMSCF₂Br either by fluoro–bromo exchange reaction of TMSCF₃ [34] or by bromination of TMSCF₂H [34,40] has also been disclosed. To obtain TMSCF₂Cl, we tried the halogen exchange reaction of TMSCF₂Br. When a 1:10 mixture of TMSCF₂Br and TMSCl was heated in neat in the presence of 5 mol % of tetrabutylammonium chloride (TBAC) for 2 hours, ¹⁹F NMR spectroscopy analysis showed that the ratio of TMSCF₂Cl to TMSCF₂Br was 2.3:1, and prolonging reaction time could not improve the ratio. In view of the difficulty in separating TMSCF₂Cl from the reaction mixture because of the approximate boiling points of TMSCF₂Cl (~85 °C) [36,37] and TMSCF₂Br (~105 °C) [36,37], other chloride sources were tried to achieve a full conversion of TMSCF₂Br. Gratifyingly, when the reaction was performed in benzonitrile (bp ~190 °C) at 80 °C using a slight excess of silver chloride under the catalysis

of TBAC, a full conversion of TMSCF₂Br afforded TMSCF₂Cl in 54% yield. Lowering the temperature to room temperature (rt) could improve the yield to 80% (Scheme 3). It is believed that the lower solubility of silver bromide than silver chloride in benzonitrile provides the driving force for this bromo–chloro exchange reaction.

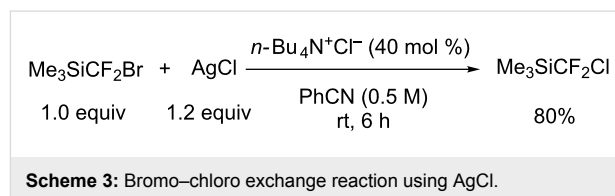

At first, the olefination of 1-naphthaldehyde (**1a**) or benzaldehyde (**1b**) by using the combination of TMSCF₂Cl and PPh₃ was tried. Conceiving that the chloride ion might be necessary to promote the decomposition of TMSCF₂Cl to release CF₂ as reported, a catalytic amount of TBAC was used as the initiator. After heating a reaction mixture of aldehyde **1a**, TMSCF₂Cl, PPh₃, and TBAC in THF at 100 °C for 8 h, ¹⁹F NMR spectroscopy analysis showed that difluorinated alkene **2a** was formed in 69% yield (Table 1, entry 1). Surprisingly, it was found that in the absence of TBAC, PPh₃ could be used both to promote the fragmentation of TMSCF₂Cl and combine with the generated :CF₂ (Table 1, entry 2). A rough comparison of the reaction temperatures showed that a lower temperature (rt) is detrimental to the olefination process, although the decomposition of TMSCF₂Cl could occur to some extent (Table 1, entries 2 and 3).

Subsequently, the olefination of aldehyde **1b** with TMSCF₂Br was examined. Unfortunately, the full consumption of

Table 1: Condition screening of *gem*-difluoroolefination with TMSCF_2X .

$\text{Ar}-\text{CHO} \quad + \quad \text{TMSCF}_2\text{X} \quad + \quad \text{PPh}_3 \quad \xrightarrow[\text{Temp, } t]{\text{THF}} \quad \text{Ar}-\text{C}(\text{F})=\text{C}(\text{F})$							
$\begin{array}{ccccccc} \text{1} & & & & & & \text{2} \\ \text{1.0 equiv} & & \text{3.0 equiv} & & \text{3.0 equiv} & & \end{array}$							
Entry ^a	Ar	X	Initiator	Temp (°C)	t (h)	Conversion (%) ^b	Yield (%) ^b
1	1-naphthyl	Cl	TBAC (3 mol %)	100	8	100	69
2	1-naphthyl	Cl	none	70	10	100	59 ^c
3	Ph	Cl	none	rt	4	35	0
4	Ph	Br	none	70	10	100	0
5	Ph	F	NaI (0.6 equiv)	70	10	<5	0
6	Ph	F	NaI (6.0 equiv)	110	10	<5	0

^aReactions were performed on 0.5 mmol scale in a pressure tube. ^bConversion of TMSCF_2X and yields of **2** were determined by ¹⁹F NMR spectroscopy using PhCF_3 as an internal standard. ^cIsolated yield of **2a**.

TMSCF_2Br did not afford any difluoroolefin **2b** (Table 1, entry 4). As determined by ¹⁹F NMR, besides the side product (difluoromethyl)triphenylphosphonium bromide ($\delta -127.9$, dd, $^3J_{\text{P-F}} = 80$ Hz, $^2J_{\text{F-H}} = 47$ Hz) as reported in the Wittig olefination with $\text{FSO}_2\text{CF}_2\text{CO}_2\text{Me}$ [25], a new product which was assigned as difluorinated phosphonium salt **4** ($\delta -88.8$, ddd, $^2J_{\text{F-F}} = 298$ Hz, $^3J_{\text{P-F}} = 97$ Hz, $^3J_{\text{F-H}} = 3.3$ Hz, 1F; $\delta -106.6$, ddd, $^2J_{\text{F-F}} = 298$ Hz, $^3J_{\text{P-F}} = 101$ Hz, $^3J_{\text{F-H}} = 24$ Hz, 1F) was detected as the major product (for details, see Supporting Information File 1). The formation of **4** is supposed to arise from a

ready silylation of the addition intermediate betaine **3** by TMSBr . When TMSCF_2Cl was used, TMSCl is not reactive enough to trap the betaine **3**, thus the oxaphosphetane **5** could be formed to give olefins and triphenylphosphine oxide (Scheme 4).

Finally, the olefination of aldehyde **1b** with TMSCF_3 as the difluoromethylene source was tested. The results showed that no desired reaction took place when PPh_3 and either substoichiometric or stoichiometric amounts of NaI were used

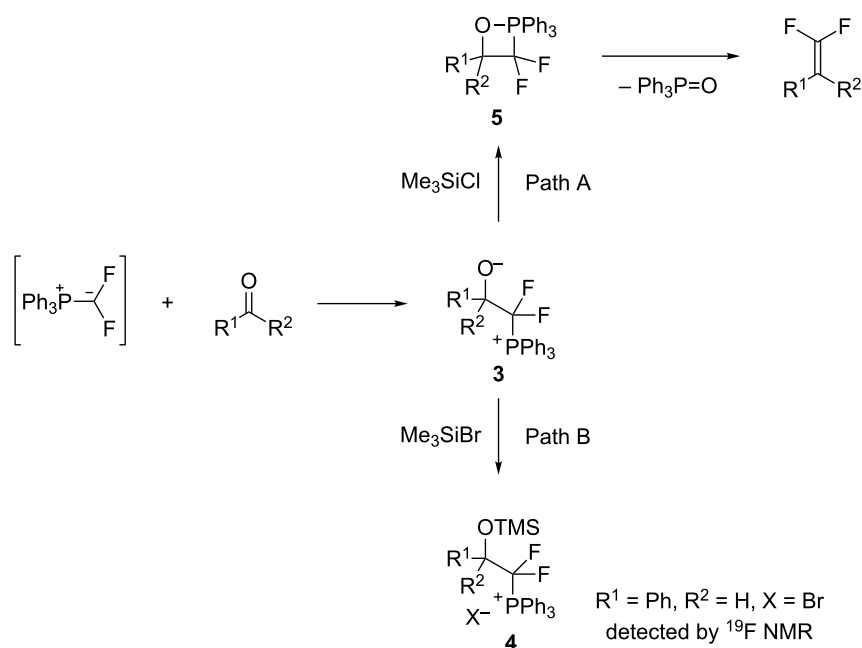
**Scheme 4:** Proposed different reaction pathways of the difluorinated ylide in the presence of TMSCl and TMSBr .

(Table 1, entries 5 and 6). Although it has been known that TMSCF_3 can be used in the difluoromethylation of alkenes and alkynes initiated by NaI [33], we could not give a reasonable explanation for the failure of the current reaction.

Using the conditions shown in Table 1, entry 2 as standard, the olefination of aldehydes with TMSCF_2Cl was investigated. As shown in Figure 1, a variety of structurally diverse aromatic aldehydes were successfully converted into *gem*-difluoro-

alkenes **2a–g** in moderate to good yields. It should be mentioned that the aromatic aldehydes with substituents such as *t*-butylthio, methoxy, and bromo groups on the phenyl ring showed similar reactivity. Moreover, this approach is also amenable to enolizable aldehydes, for example, *gem*-difluoroolefin **2h** could be obtained in 47% yield. Although a non-activated ketone such as acetophenone is unreactive under similar conditions, activated ketones could undergo this Wittig olefination reaction. Representative results for the olefination at a

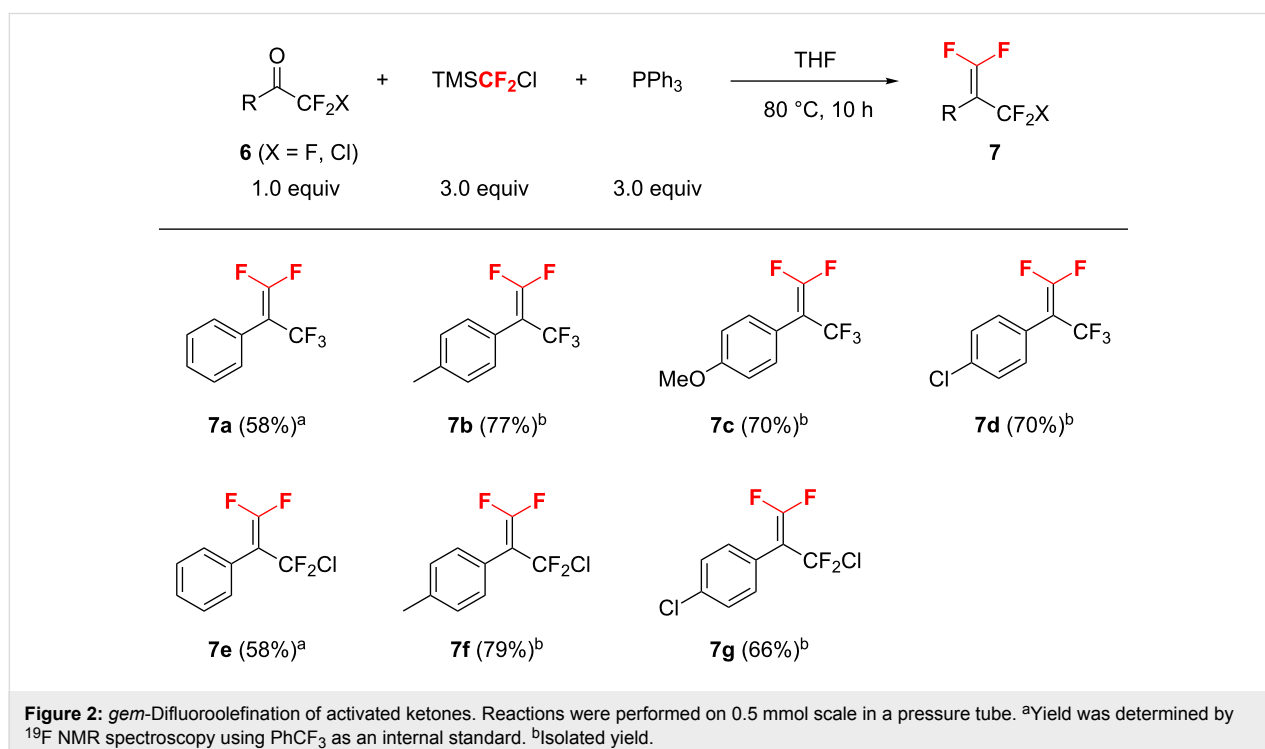
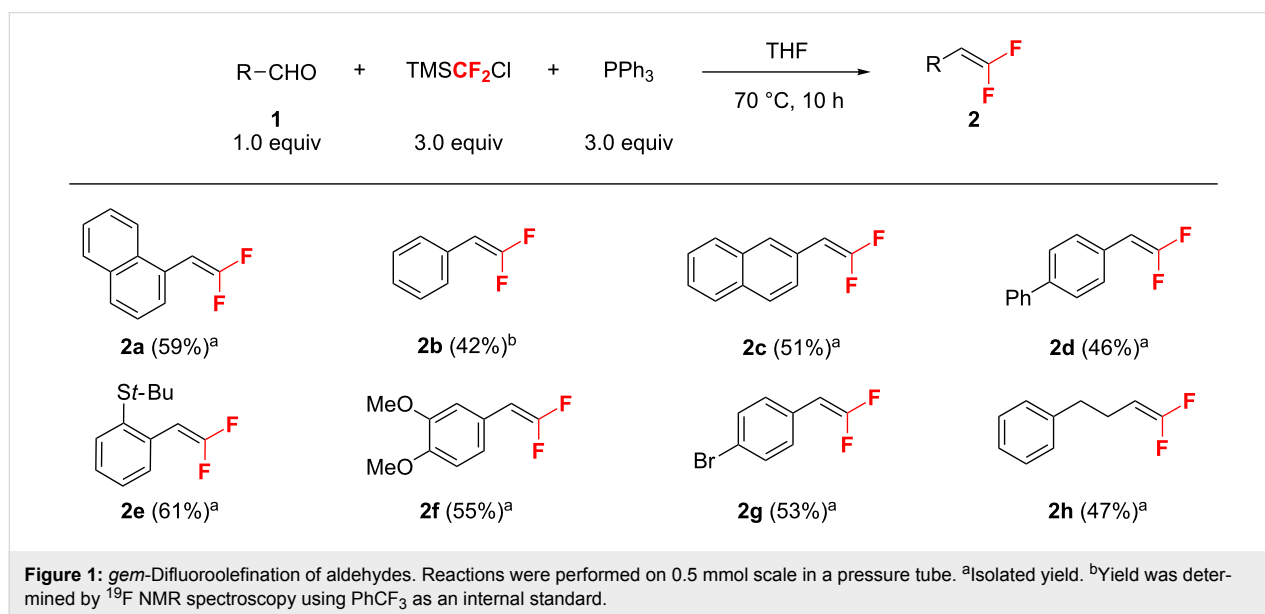

slightly elevated temperature (80 °C) are shown in Figure 2. A range of aryl trifluoromethyl (**6a–d**) and chlorodifluoromethyl aromatic ketones (**6e–g**) were readily difluoromethylated to give the corresponding olefins (**7a–g**) in moderate to good yields. It should be mentioned that in all cases, the formation of *gem*-difluoroolefins was accompanied by the formation of Ph_3PF_2 ($\delta -41.2$, d, $^1J_{\text{P-F}} = 668$ Hz) [25], HCF_2Cl , fluorotrimethylsilane, and some unidentified byproducts in variable yields (for details, see Supporting Information File 1).

As previously reported, the key mechanistic issue of this Wittig-type reaction is the formation of the presumed difluoromethylene triphenylphosphonium ylide [19–25]. Initially it was speculated that it were trace amounts of nucleophilic impurities (such as chloride ions) that initiated the fragmentation of TMSCF_2Cl to release $:\text{CF}_2$ [31], which combined with PPh_3 to form the ylide. However, the experiment at room temperature showed that PPh_3 could significantly accelerate the decomposition of TMSCF_2Cl , which indicated that PPh_3 should have participated in the activation of TMSCF_2Cl . Consequently, two plausible mechanisms are proposed (Scheme 5): one is the initial activation of the C–Si bond by PPh_3 (Path A), the other is the initial activation of the C–Cl bond by PPh_3 (Path B). In Path

A, PPh_3 firstly coordinates the silicon atom of TMSCF_2Cl to form activated penta-coordinated silicon species **8** [41] and activates both the C–Si and the C–Cl bond. Next, the release of CF_2 leads to silylphosphonium salt **9**. Finally, the fragmentation of **9** occurs to give TMSCl with regeneration of PPh_3 ; meanwhile, the trapping of $:\text{CF}_2$ by PPh_3 gives the ylide. In Path B, a phosphonium salt **10**, which is formed via a single-electron transfer (SET) mechanism, undergoes a chloride ion-promoted desilylation reaction to afford $\text{Ph}_3\text{P}=\text{CF}_2$ [42,43]. However, we could not rule out the possibility of chloride ion-activation in these processes due to the involvement of intermediates **9** and **10** in the proposed mechanisms.

Conclusion

In conclusion, a robust difluoromethylation reagent (chlorodifluoromethyl)trimethylsilane (TMSCF_2Cl) has been prepared via a relatively environmentally benign method and has been successfully used in the Wittig difluoroolefination. Similar as many other Wittig-type *gem*-difluoroolefination reactions in the presence of PPh_3 , the reaction of TMSCF_2Cl with aldehydes and activated ketones is effective. Comparative reactions with TMSCF_2Br and TMSCF_3 under similar conditions failed to give the *gem*-difluorinated olefins, which indicate that the halo-

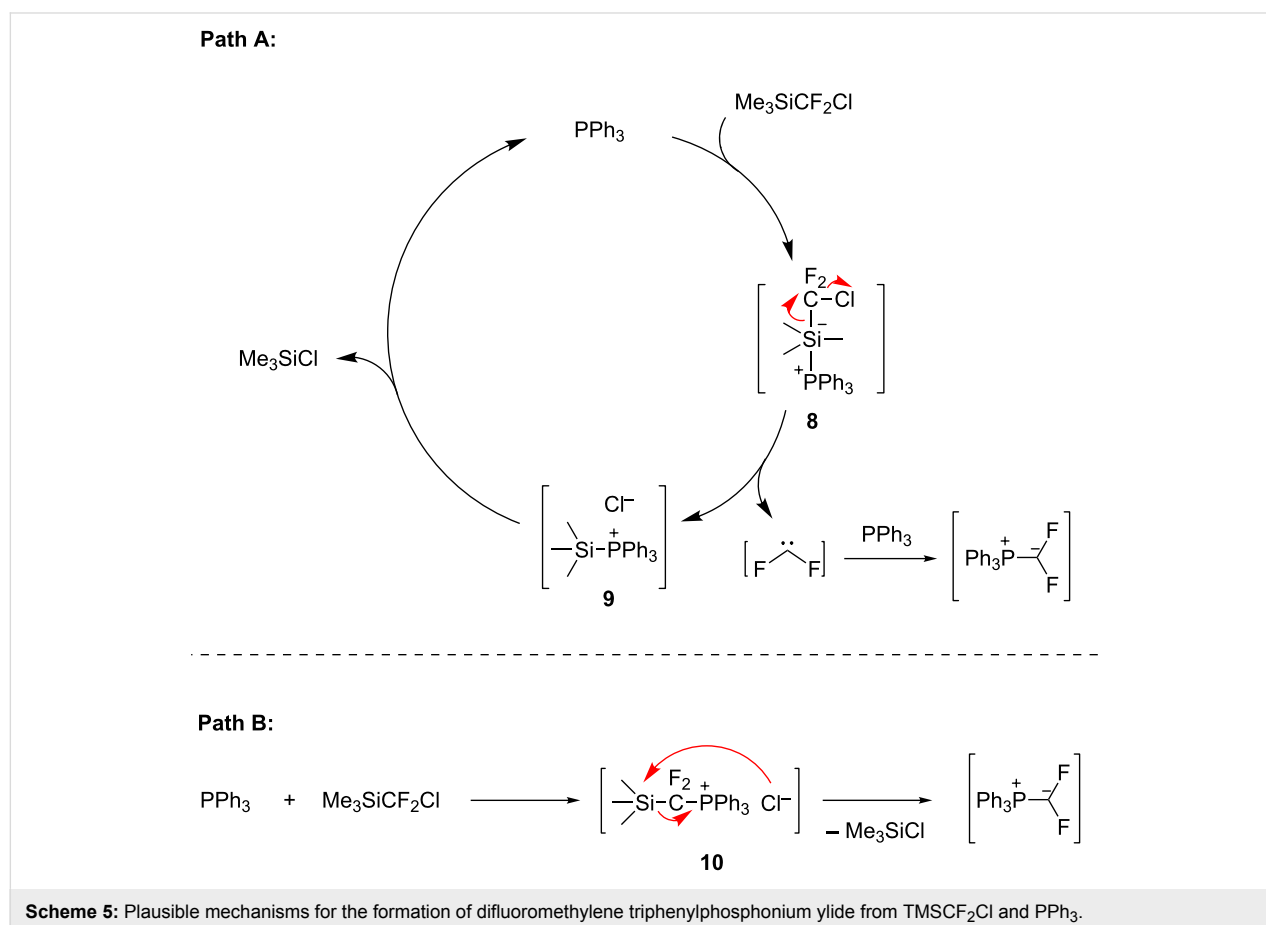

substituent of TMSCF_2X can influence the reactivity of these fluorinated silanes in difluoromethylene transfer reactions. Further research on the synthetic application of TMSCF_2X ($\text{X} = \text{F}, \text{Cl}, \text{and Br}$) is currently underway.

Supporting Information

Full experimental details (difluoromethylation of *O*, *S*, and *N*-nucleophiles and *gem*-difluoroolefination of carbonyl compounds with TMSCF_2Cl) and compound characterization data are given.

Supporting Information File 1

Experimental procedures and characterization data.

[<http://www.beilstein-journals.org/bjoc/content/supplementary/1860-5397-10-32-S1.pdf>]

Acknowledgements

Support of our work by the National Basic Research Program of China (2012CB821600 and 2012CB215500) the National Natural Science Foundation of China (20825209 and 21202189), and the Chinese Academy of Sciences is gratefully acknowledged.

References

- Chambers, R. D. *Fluorine in Organic Chemistry*; Blackwell: Oxford, 2004.
 - Bégué, J.-P.; Bonnet-Delpon, D. *Bioorganic and Medicinal Chemistry of Fluorine*; John Wiley and Sons: Hoboken, 2008.
 - Kirsch, P. *Modern Fluoroorganic Chemistry: Synthesis, Reactivity, Applications*, 2nd ed.; Wiley-VCH: Weinheim, 2013.
 - McDonald, I. A.; Lacoste, J. M.; Bey, P.; Palfreyman, M. G.; Zreika, M. *J. Med. Chem.* **1985**, *28*, 186–193. doi:10.1021/jm00380a007
 - Altenburger, J.-M.; Lassalle, G. Y.; Matrougui, M.; Galtier, D.; Jetha, J.-C.; Bocskai, Z.; Berry, C. N.; Lunven, C.; Lorrain, J.; Herault, J.-P.; Schaeffer, P.; O'Connor, S. E.; Herbert, J.-M. *Bioorg. Med. Chem.* **2004**, *12*, 1713–1730. doi:10.1016/j.bmc.2004.01.016
 - Weintraub, P. M.; Holland, A. K.; Gates, C. A.; Moore, W. R.; Resvick, R. J.; Bey, P.; Peet, N. P. *Bioorg. Med. Chem.* **2003**, *11*, 427–431. doi:10.1016/S0968-0896(02)00434-0
 - Blackburn, G. M.; England, D. A.; Kolkman, F. *J. Chem. Soc., Chem. Commun.* **1981**, 930–932. doi:10.1039/C39810000930
 - Lapierre, J.; Ahmed, V.; Chen, M.-J.; Ispahany, M.; Guillemette, J. G.; Taylor, S. D. *Bioorg. Med. Chem. Lett.* **2004**, *14*, 151–155. doi:10.1016/j.bmcl.2003.09.089
 - Navidpour, L.; Lu, W.; Taylor, S. D. *Org. Lett.* **2006**, *8*, 5617–5620. doi:10.1021/ol062357z
 - Motherwell, W. B.; Tozer, M. J.; Ross, B. C. *J. Chem. Soc., Chem. Commun.* **1989**, 1437–1439. doi:10.1039/C39890001437
 - Chambers, R. D.; Vaughan, J. F. S. *Top. Curr. Chem.* **1997**, *192*, 1–38. doi:10.1007/BFb0119264
 - Nguyen, B. V.; Burton, D. J. *J. Org. Chem.* **1997**, *62*, 7758–7764. doi:10.1021/jo971019w
 - Hayashi, S.-i.; Nakai, T.; Ichikawa, N.; Burton, D. J.; Naae, D. G.; Kesling, H. S. *Chem. Lett.* **1979**, *8*, 983–986. doi:10.1246/cl.1979.983
 - Ichikawa, J.; Wada, Y.; Okauchi, T.; Minami, T. *Chem. Commun.* **1997**, 1537–1538. doi:10.1039/A703110F
 - Yokota, M.; Fujita, D.; Ichikawa, J. *Org. Lett.* **2007**, *9*, 4639–4642. doi:10.1021/ol702279w
 - Hayashi, S.-i.; Nakai, T.; Ishikawa, N. *Chem. Lett.* **1980**, *9*, 651–654. doi:10.1246/cl.1980.651
 - Chelucci, G. *Chem. Rev.* **2012**, *112*, 1344–1462. doi:10.1021/cr200165q
 - Liu, Y.; Deng, M.; Zhang, Z.; Ding, X.; Dai, Z.; Guan, J. *Chin. J. Org. Chem.* **2012**, *32*, 661–666. doi:10.6023/cjoc1104113
 - Fuqua, S. A.; Duncan, W. G.; Silverstein, R. M. *Tetrahedron Lett.* **1964**, *5*, 1461–1463. doi:10.1016/S0040-4039(01)89512-5
 - Herkes, F. E.; Burton, D. J. *J. Org. Chem.* **1967**, *32*, 1311–1318. doi:10.1021/jo01280a007
 - Zheng, J.; Cai, J.; Lin, J.-H.; Guo, Y.; Xiao, J.-C. *Chem. Commun.* **2013**, *49*, 7513–7515. doi:10.1039/C3CC44271C
 - Naae, D. G.; Burton, D. J. *J. Fluorine Chem.* **1971**, *1*, 123–125. doi:10.1016/S0022-1139(00)82541-5
 - Naae, D. G.; Burton, D. J. *Synth. Commun.* **1973**, *3*, 197–200. doi:10.1080/00397917308062035
 - Nowak, I.; Robins, J. M. *Org. Lett.* **2005**, *7*, 721–724. doi:10.1021/ol047416s
 - Thomson, C. S.; Martinez, H.; Dolbier, W. R., Jr. *J. Fluorine Chem.* **2013**, *150*, 53–59. doi:10.1016/j.jfluchem.2013.02.026
 - Zheng, J.; Lin, J.-H.; Cai, J.; Xiao, J.-C. *Chem.–Eur. J.* **2013**, *19*, 15261–15266. doi:10.1002/chem.201303248
- This article appeared online after our submission of this article. It is a paper describing the deoxygenative *gem*-difluoroolefination of carbonyl compounds with the difluorocarbene/phosphine procedures, i.e. $\text{HCF}_2\text{Cl}/\text{propylene epoxide}/n\text{-Bu}_4\text{NCl}$ (cat.)/ Ph_3P ; $\text{FSO}_2\text{CF}_2\text{CO}_2\text{TMS}/\text{NaF}$ (cat.)/ Ph_3P .
- Zhang, L.; Zheng, J.; Hu, J. *J. Org. Chem.* **2006**, *71*, 9845–9848. doi:10.1021/jo061799l
 - Zheng, J.; Li, Y.; Zhang, L.; Hu, J.; Meuzelaar, G. J.; Federsel, H.-J. *Chem. Commun.* **2007**, 5149–5151. doi:10.1039/B713156A
 - Zhang, W.; Wang, F.; Hu, J. *Org. Lett.* **2009**, *11*, 2109–2112. doi:10.1021/ol900567c
 - Wang, F.; Huang, W.; Hu, J. *Chin. J. Chem.* **2011**, *29*, 2717–2721. doi:10.1002/cjoc.201100325
 - Wang, F.; Zhang, W.; Zhu, J.; Li, H.; Huang, K.-W.; Hu, J. *Chem. Commun.* **2011**, *47*, 2411–2413. doi:10.1039/c0cc04548a
32. For preliminary results on the difluoromethylation of *O*, *S*, and *N*-nucleophiles with TMSCF_2Cl under aqueous basic conditions, see Supporting Information File 1.
- Wang, F.; Luo, T.; Hu, J.; Wang, Y.; Krishnan, H. S.; Jog, P. V.; Ganesh, S. K.; Prakash, G. K. S.; Olah, G. A. *Angew. Chem., Int. Ed.* **2011**, *50*, 7153–7157. doi:10.1002/anie.201101691
 - Li, L.; Wang, F.; Ni, C.; Hu, J. *Angew. Chem., Int. Ed.* **2013**, *52*, 12390–12394. doi:10.1002/anie.201306703
 - Ruppert, I.; Schlich, K.; Volbach, W. *Tetrahedron Lett.* **1984**, *25*, 2195–2198. doi:10.1016/S0040-4039(01)80208-2
 - Broicher, V.; Geffken, D. *J. Organomet. Chem.* **1990**, *381*, 315–320. doi:10.1016/0022-328X(90)80061-4
 - Yudin, A. K.; Prakash, G. K. S.; Deffieux, D.; Bradley, M.; Bau, R.; Olah, G. A. *J. Am. Chem. Soc.* **1997**, *119*, 1572–1581. doi:10.1021/ja962990n

38. Prakash, G. K. S.; Hu, J.; Olah, G. A. *J. Org. Chem.* **2003**, *68*, 4457–4463. doi:10.1021/jo030110z
39. Prakash, G. K. S.; Jog, P. V.; Batamack, P. T. D.; Olah, G. A. *Science* **2012**, *338*, 1324–1327. doi:10.1126/science.1227859
40. Kosobokov, M. D.; Dilman, A. D.; Levin, V. V.; Struchkova, M. I. *J. Org. Chem.* **2012**, *77*, 5850–5855. doi:10.1021/jo301094b
41. Matsukawa, S.; Saijo, M. *Tetrahedron Lett.* **2008**, *49*, 4655–4657. doi:10.1016/j.tetlet.2008.05.053
42. Miller, N. E. *J. Am. Chem. Soc.* **1965**, *87*, 390–391. doi:10.1021/ja01080a049
43. McNulty, J.; Das, P. *Chem.–Eur. J.* **2008**, *14*, 8469–8472. doi:10.1002/chem.200801358

License and Terms

This is an Open Access article under the terms of the Creative Commons Attribution License (<http://creativecommons.org/licenses/by/2.0>), which permits unrestricted use, distribution, and reproduction in any medium, provided the original work is properly cited.

The license is subject to the *Beilstein Journal of Organic Chemistry* terms and conditions: (<http://www.beilstein-journals.org/bjoc>)

The definitive version of this article is the electronic one which can be found at:
[doi:10.3762/bjoc.10.32](https://doi.org/10.3762/bjoc.10.32)

A novel family of (1-aminoalkyl)(trifluoromethyl)- and -(difluoromethyl)phosphinic acids – analogues of α -amino acids

Natalia V. Pavlenko¹, Tatiana I. Oos¹, Yurii L. Yagupolskii*¹, Igor I. Gerus², Uwe Doeller³ and Lothar Willms³

Full Research Paper

Open Access

Address:

¹Institute of Organic Chemistry National Academy of Sciences of Ukraine, Murmanskaya str. 5, 02660 Kiev-94, Ukraine, ²Institute of Bioorganic Chemistry and Petrochemistry National Academy of Sciences of Ukraine, Murmanskaya str. 1, 02660 Kiev-94, Ukraine and ³Bayer CropScience Aktiengesellschaft BCS AG-R-WC-WCC-C2 Weed Control Chemistry 2, Frankfurt, G836, 101, Germany

Email:

Yurii L. Yagupolskii* - Yagupolskii@ioch.kiev.ua

* Corresponding author

Keywords:

(1-aminoalkyl)phosphinic acids; ethyl (difluoromethyl)phosphinate; hydrophosphinylation; organo-fluorine; Schiff bases; (trifluoromethyl)phosphinic acid

Beilstein J. Org. Chem. **2014**, *10*, 722–731.

doi:10.3762/bjoc.10.66

Received: 02 December 2013

Accepted: 05 March 2014

Published: 26 March 2014

This article is part of the Thematic Series "Organo-fluorine chemistry III".

Guest Editor: D. O'Hagan

© 2014 Pavlenko et al; licensee Beilstein-Institut.

License and terms: see end of document.

Abstract

A series of novel (1-aminoalkyl)(trifluoromethyl)- and -(difluoromethyl)phosphinic acids – analogues of proteinogenic and nonproteinogenic α -amino acids were prepared. The synthetic methodology was based on nucleophilic addition of (trifluoromethyl)phosphinic acid or (difluoromethyl)phosphinic acid or its ethyl ester to substrates with C=N or activated C=C double bonds. Analogues of glycine, phenylglycine, alanine, valine, proline, aminomalonic and aspartic acids were thus prepared. Three-component one-pot reactions of (trifluoromethyl)phosphinic acid and dibenzylamine with aldehydes were also tested to prepare the title compounds.

Introduction

For a long time aminophosphonic and aminophosphinic acids as isosters of aminocarboxylic acids have attracted a particular interest for the preparation of analogues of numerous natural products. Among the literature concerning various aspects of the chemistry and biological activity of aminophosphonic and aminophosphinic acids, several monographs and reviews have

appeared over the last decade [1-6]. The chemistry of fluorinated aminophosphonic and -phosphinic acids is a relatively new area of research. Incorporation of fluorine or fluorinated moieties can be used for the alteration of physiological properties of many biologically significant substances. The changes of their biological properties caused by this fluorination are

influenced by complex factors, however. The similarity of the diameters of fluorine and hydrogen atoms in organic compounds makes fluorine an obvious choice as a substituent for biologically active substances, frequently without disrupting the shape and geometry of the substituted molecules. Nevertheless fluorine influences the electronic properties of a compound drastically because of its strong electronegativity. This enables modulation of the lipophilicity profile, of electrostatic interactions with the target structure and inhibition of some metabolic pathways [7–9]. Data concerning the biological activity and synthetic approaches toward fluorinated aminophosphonates, bearing side chain C–F linkages are well documented in a review [10].

The isolation of phosphinothricin, a naturally occurring phosphorus analogue of glutamic acid and the discovery of its antibiotic, fungicidal and herbicidal properties [11] has led to an increased activity in the study of methylphosphinic acid analogues of the protein amino acids [12] and those of glycine [13], alanine [14], valine [14], leucine [15], proline [16], aspartic [17] and glutamic [11] acids and GABA [18] have been described. But almost nothing is known about phosphorus isosters of aminocarboxylic acids bearing a (trifluoromethyl)- or (difluoromethyl)phosphonyl moiety instead of the carboxylate function. To the best of our knowledge there is only one report on the application of ethyl (difluoromethyl)phosphinate $\text{CHF}_2(\text{H})\text{P}(\text{O})(\text{OEt})$ in the synthesis of a (difluoromethyl)phosphinic acid analogue of GABA, as a potent agonist of the GABA_B receptor [18].

In light of the above and in connection with our interest in the chemistry of fluorinated compounds of phosphorus we report here the preparation of a series of novel (1-aminoalkyl)phosphinic acids bearing CF_3 or CHF_2 groups at phosphorus.

Results and Discussion

Research efforts have established H-phosphinates $\text{R}(\text{H})\text{P}(\text{O})(\text{OR}')$ or appropriate P(III) acids $\text{R}(\text{H})\text{P}(\text{O})(\text{OH})$ as appropriate starting materials for the preparation of aminophosphinic acids. The most typical route involves the three-component reaction of an aldehyde, an amine and a P–H substrate in a one-pot Mannich type protocol [19–21]. An alternative to this approach involves the simple addition of alkyl H-phosphinates or H-phosphinic acids to Schiff bases [5,22]. In this paper we exploit both routes to prepare (1-aminoalkyl)(trifluoromethyl)- and -(difluoromethyl)phosphinic acids using P–H compounds bearing CF_3 and CHF_2 groups attached to phosphorus.

P–H Substrates

(Trifluoromethyl)phosphinic acid $\text{CF}_3\text{P}(\text{O})\text{H}(\text{OH})$ (**1**) was first prepared in 1954 [23], but since then little chemistry has been

reported involving **1**. Also monoesters of **1** such as $\text{CF}_3\text{P}(\text{O})\text{H}(\text{OAlk})$ [24,25] have not been widely applied. These compounds, contain a labile P–H bond and synthetic problems underly their preparation. Emel us and Haszeldine were the first [26] to prepare $\text{CF}_3\text{P}(\text{III})$ compounds via the interaction of red phosphorus and CF_3I in an autoclave. This gave mixtures of CF_3 -containing phosphanes and phosphane iodides but in poor yields. More recently, Ruppert described the reaction between CF_3Br , $\text{P}(\text{NET}_2)_3$ and PCl_3 , which gave $\text{CF}_3\text{P}(\text{NET}_2)_2$ in a good yield [27]. We applied this procedure to prepare CF_3PCl_2 [27] by interaction of diamide $\text{CF}_3\text{P}(\text{NET}_2)_2$ with gaseous HCl and then the chlorine was replaced by neutral hydrolysis to give (trifluoromethyl)phosphinic acid (**1**) [23] or by alcoholysis with ethanol or isopropanol to reach the appropriate esters **2–4** [24,25] (Scheme 1).

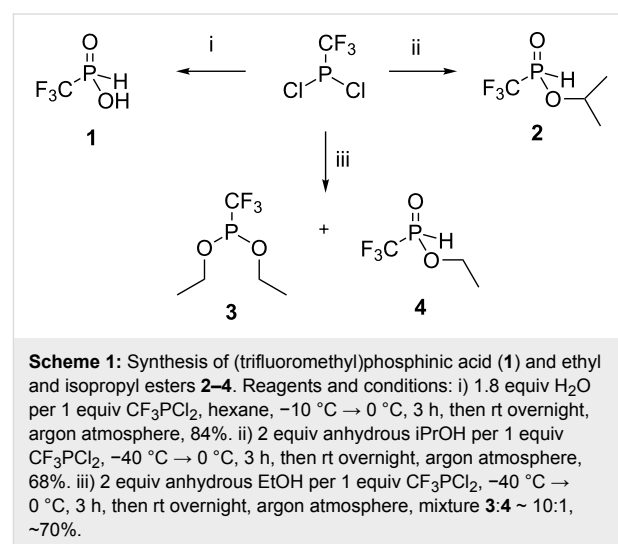

In our hands CF_3PCl_2 was hydrolyzed by two equivalents of water in hexane over the temperature range $-10\text{ }^\circ\text{C} \rightarrow 0\text{ }^\circ\text{C}$, to give water-free (trifluoromethyl)phosphinic acid (**1**). Acid **1** proved easy to handle as a distillable liquid when prepared in this way and is stable under storage for months in contrast to that prepared by Emel us and Haszeldine [23]. Phosphinate **2** was prepared with anhydrous isopropanol. When stored under anhydrous conditions at room temperature, ester **2** was partially converted to acid **1** as determined by ^{31}P NMR. Alcoholysis of CF_3PCl_2 with ethanol under the same conditions produced diethyl phosphinate **3** admixed with monoester **4** (~10%), as previously described [25]. ^{31}P NMR of these products indicated that they were converted to esters **3** and **4** on storage in a ratio of ~ 3:2 with acid **1** as an impurity. The low stability of all three esters **2–4** can be attributed to the lability of the O–C ester bond, resulting from the electron-withdrawing effect of the CF_3 group attached to phosphorus, therefore esters **2**, **3** and **4** were used in the syntheses only when freshly prepared and distilled.

We next explored the CHF₂ group attached to phosphorus. Ethyl (difluoromethyl)phosphinate CHF₂P(O)H(OEt) (**5**) was prepared as previously described [18]. The appropriate (difluoromethyl)phosphinic acid CHF₂P(O)H(OH) (**6**) was obtained from **5** by ester deprotection with NaHCO₃, as a viscous undistillable liquid, which was stable for weeks on storage.

Three-component reactions

At the outset of our work three-component reactions of formaldehyde, dibenzylamine and the esters **2** or **5** were explored as model transformations to evaluate the feasibility of the Kabachnik–Fields procedure [19,20] to the synthesis of fluorinated (1-aminoalkyl)phosphinate **7** (Scheme 2).

It turned out that this method is unsuitable for the synthesis of phosphinate **7**. Formalin was added to an equimolar mixture of dibenzylamine and ester **2** at 80 °C under an oxygen-free atmosphere to give reaction mixtures with a low content of P–C products (³¹P NMR). A similar outcome was obtained when the reaction was run at room temperature or in dioxane with simul-

taneous water azeotropic distillation. Such a result might be explained by high reactivity of the starting ester, which readily reacted with formaldehyde, forming (α-hydroxymethyl)phosphinate **8**. Its further irreversible rearrangement [28] to the corresponding phosphonate **9** was accompanied with hydrolysis of the ester function and formation of (trifluoromethyl)phosphonic acid (**10**) [29] as the main product. Analogous results were obtained, when CHF₂ containing ester **5** was introduced into the reaction with formaline and dibenzylamine to give CHF₂P(O)(OH)₂ (**11**) as the major product [30].

Such results prompted us to explore the Mannich-type procedure of Moedritzer and Irani [21] for the syntheses of the desired aminophosphinic acids starting from acid **1**. This resulted in the preparation of the analogues of glycine **14a** and phenylglycine **14b** (Scheme 3).

The three-component reaction with formaldehyde gave the best results and *N*-protected aminophosphinic acid **13a** was isolated in a moderate yield, alongside phosphonic acid **10**. The analo-

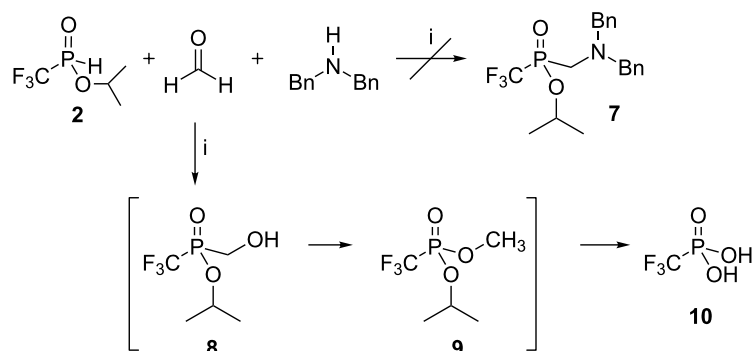

Scheme 2: Three-component Kabachnik–Fields reaction of CF₃(H)P(O)(OiPr) (**2**) with formaldehyde and dibenzylamine. Reagents and conditions: i) an equimolar mixture of reagents, H₂O, 80 °C, 3 h, argon atmosphere, yield **10** ~80% or an equimolar mixture of reagents, dioxane, 100 °C, 3 h, argon atmosphere, yield **10** ~90%.

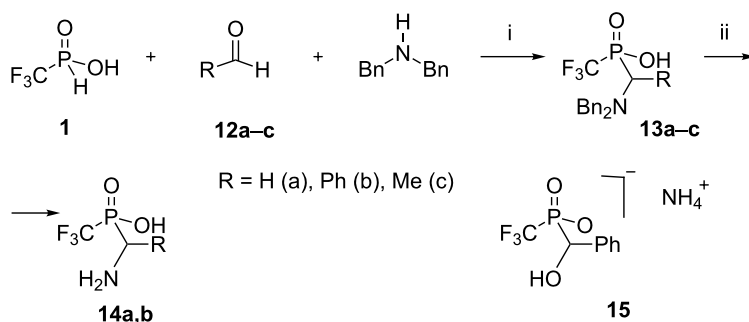

Scheme 3: Three-component synthesis of CF₃ containing α-aminophosphinic acids **14a,b**. Reagents and conditions: i) An equimolar mixture of acid **1**, dibenzylamine, HCl and two fold excess of aldehyde, H₂O, 80 °C, 3 h; isolated yields: **13a** (52%), **13b** (28%); yields, determined by ³¹P and ¹⁹F NMR: **13c** (<10%). ii) H₂, ethanol, catalysis 10% Pd/C, rt, normal pressure, yields: **14a** (95%), **14b** (90%).

gous reaction with benzaldehyde provided acid **13b** in 28% yield and the main product of this reaction was an adduct of acid **1** with benzaldehyde which was isolated from the reaction mixture as ammonium salt **15** in 60% yield. Reaction with acetaldehyde was less successful and generated aminophosphinic acid **13c** in low yield (<10%). Attempts to improve conversions products **13a–c** by increasing the reaction temperature or varying the amino component (MeC(O)NH₂, BnOC(O)NH₂ or NH₄OAc instead of Bn₂NH) and molar equivalent of HCl were unsuccessful. It should be noted, that in contrast to the non-fluorinated counterparts the adducts **13a,b** did not form hydrochlorides under this procedure consistent with the strongly acidic nature of the CF₃ phosphinic acid

group. Catalytic hydrogenation of intermediates **13a,b** with Pd/C removed the benzyl groups and produced the corresponding acids **14a,b** in high yields.

The hydrophosphinylation of azomethines

The addition of the P–H functionality to C=N double bonds is a very general procedure for the formation of P–C–N systems. Based on our experience of these three-component reactions (Scheme 2 and Scheme 3) we investigated the scope and limitations of the addition of (trifluoromethyl)phosphinic acid (**1**) to a series of *N*-benzylimines **16a–e** in order to obtain fluorinated phosphorus analogues of glycine **14a**, phenylglycine **14b**, alanine **14c**, valine **14d** and proline **14e** (Table 1).

Table 1: The interaction of (trifluoromethyl)phosphinic acid (**1**) with Schiff bases.^a

Entry	Shiff base	R	17 (yield, %) ^b	14 (yield, %) ^b
1 ^c		H	17a (83)	14a (95)
2		Ph	17b (79)	14b (96)
3 ^d		Me	17c (59)	14c (96)
4		iPr	17d (92)	14d (98)
5 ^c			–	14e (66)

^aReagents and conditions: i) an equimolar mixture of acid **1** and Schiff base, DME, rt, ³¹P NMR control; ii) H₂, ethanol, catalysis 10% Pd/C, rt, normal pressure. ^bIsolated yields. ^cSymmetrical cyclic triazinanes (masked imines) were used to generate unstable imines. ^dThe best yield was obtained with 2 mol equivalents of imine.

The transformations were mildly exothermic and were monitored by ^{31}P NMR. Acid **1** undergoes the typical P–C bond forming reactions with Schiff bases to give adducts **17** in satisfactory yields and these were successfully transformed into the appropriate free acids **14**.

The same series of Schiff bases was used to explore the reactivity of ethyl (difluoromethyl)phosphinate (**5**) in reactions with C=N double bonds and the desired (α -aminoalkyl)phosphinic acids **20a–e** were accordingly prepared (Table 2).

The syntheses of compounds **20a–e** were performed with purification and characterization of the intermediates, wherever possible as summarized in Table 2.

Products **14b–e** and **20b–e** were obtained as racemic mixtures. As expected, the ^{31}P NMR spectra of **14** and **20** display characteristic signals around 11–15 ppm with $^2J_{\text{FP}}$ couplings for CF_3 bearing substrates. The CHF_2 bearing also possessed $^2J_{\text{FP}}$ couplings of 75–95 Hz. The ^{19}F NMR spectra were characterized by signals in the region –75 ppm for CF_3 derivatives and

Table 2: The interaction of ethyl (difluoromethyl)phosphinate (**5**) with Schiff bases.^a

Entry	Schiff base	R	18 (yield, %) ^b	19 (yield, %) ^b	20 (yield, %) ^b
	$16\text{a} (=N\text{Bn})_3, 16\text{b-d}, 16\text{e} (\text{cyclic imine})_3$				
	R = H (a), Ph (b), Me (c), iPr (d), (e)				
1 ^c		H	18a (78) ^d	19a (68)	20a (91)
2		Ph	18b (58) ^e	19b (86) ^f	20b (96)
3 ^g		Me	18c (56) ^e	19c (80) ^f	20c (95)
4		iPr	18d (36) ^e	19d (82) ^f	20d (95)
5 ^c			–	–	20e (79)

^aReagents and conditions: i) an equimolar mixture of ester **5** and Schiff base, DME, rt, ^{31}P NMR control, under argon atmosphere; ii) 1 N HCl, rt, until clear solution; iii) H_2 , ethanol, catalysis 10% Pd/C, rt, normal pressure. ^bIsolated yields. ^cSymmetrical cyclic triazinanes (masked imines) were used to generate unstable imines. ^dYield was defined with ^{31}P NMR. ^eDiastereomeric ratio: **18b** (~7:2), **18c** (~3:2), **18d** (~3:2). ^fYields were defined as the sum of yields of compounds **19b–d**, isolated from the reaction mixture and obtained after hydrolysis of intermediates **18b–d**. ^gThe maximum yield was obtained with 2 mol equivalents of imine.

–137 ppm for CHF₂ ones. Some distinctive characteristics of the reactivity of ester **5** were observed. This ester readily reacted with azomethines, but in contrast to its nonfluorinated counterparts this ester generated mixtures of the adducts **18** and **19**. The interaction of ester **5** with imine **16a** gave adduct **18a** (Table 2, entry 1) in high conversion yield but after purification over silica gel only the appropriate acid **19a** was isolated. In the case of the reaction of ester **5** with imine **16e** no adduct was formed. Ethyl phosphinates **18b–d** were obtained as a mixture of two diastereoisomers, which were not separated but they are clearly observed by ¹H NMR as separate signals for the CHF₂ group. The adducts **18b–d** were hydrolyzed to acids **19b–d** in quantitative yields and did not form hydrochlorides similar to the CF₃ aminophosphinic acids **13a–b** and **17a–d**. Hydrogenolysis of the **17a–d** and **19a–d** efficiently gave free acids **14** and **20**, but required column ion-exchange chromatography to produce analytically pure products.

We then explored the addition of acid **1** to imine **21** [31], which is *N*-Boc protected, typically used for amino acid protection (Scheme 4). This produced acid **14b** in one step, but in only 32% yield. The *N*-*tert*-butoxycarbonyl group was removed during the reaction due to the high acidity of the CF₃ phosphinic acid group.

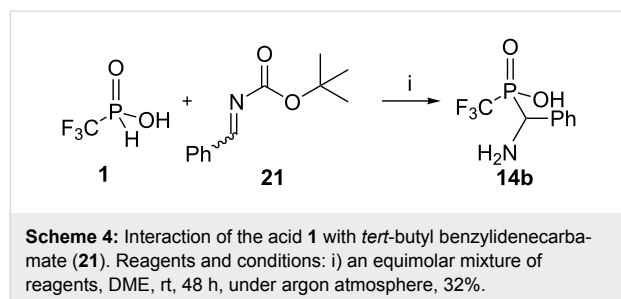

The variability of Schiff bases ensures access to a range of structurally diverse phosphinic acid analogues of amino acids in the relatively simple way. Thus, we investigated the hydrophosphinylation of some Schiff bases bearing a carboxylate functionality to obtain aminocarboxylic acids, containing pendant CF₃ or CHF₂ phosphinic acid linkages. Thus, phosphinic acids **1** and **6** reacted with the *N*-Boc-protected Schiff base of ethyl glyoxalate **22** [32] under mild conditions to produce the *N*-deprotected phosphinylglycines **23** and **24** in satisfactory yields (Scheme 5).

Attempts to convert ester **23** to the free acid failed. Removal of the ester group from **23** by acidolysis with HCl or HI was accompanied by cleavage of the P–C bond to give only (trifluoromethyl)phosphonic acid (**10**) after an ion-exchange chromatography. Attempts to remove the ester group in anhydrous base

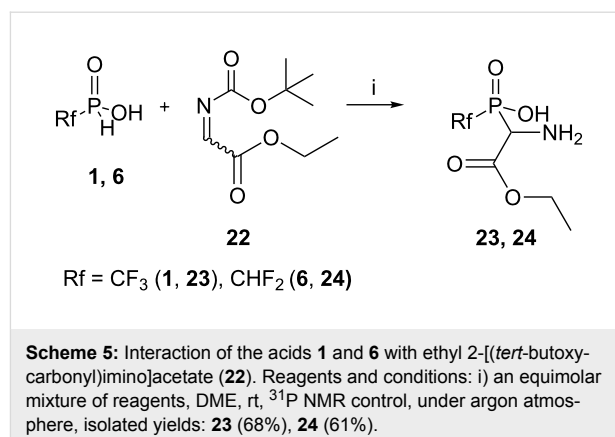

with 1 equivalent of sodium silanolate (Me₃SiONa) at room temperature efficiently produced the highly stable sodium salt of acid **23**. With an excess of Me₃SiONa and heating to 50 °C, fluoroform liberation from **23** was observed to give fluorine-free products.

In contrast the CHF₂-containing ester **24** was stable toward acidic hydrolysis under mild conditions, but in the presence of an excess of sodium silanolate, free phosphinylglycine **25** was obtained, but in a poor yield (Scheme 6).

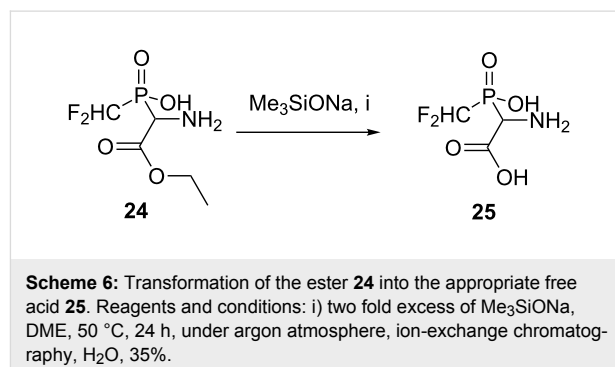

The reactions of substrates **1** and **6** with imine **26**, which is available from valine [33], readily gave adducts **27** and **28**, which were decarboxylated under acidolysis to afford the phosphinic acid analogues of valine **14d** and **20d** (Scheme 7).

The hydrophosphinylation of substrates with activated C=C double bonds

The high reactivity of (trifluoromethyl)phosphinic acid (**1**) with C=N double bonds prompted us to explore its reactivity towards activated C=C double bonds. By analogy with the synthesis of the phosphonic acid analogue of aspartic acid, developed by Chambers and Isbell [34], the P–H substrate **1** was reacted with *N*-Boc-protected aminoacrylate **29** [35], and this gave the precursor of the aspartic acid analogue **30** (Scheme 8).

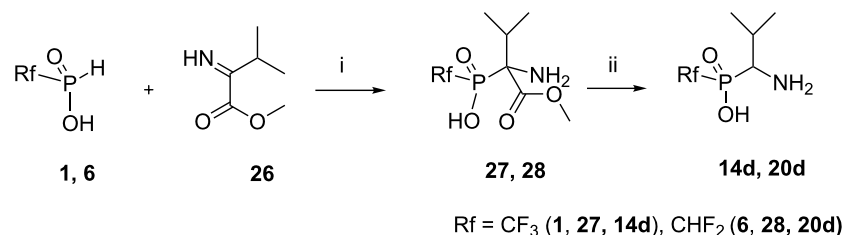

Scheme 7: Reaction of the acids (**1**) and (**6**) with methyl 2-imino-3-methylbutanoate (**26**). Reagents and conditions: i) an equimolar mixture of reagents, DME, rt, ³¹P NMR control, under argon atmosphere, isolated yields: **27** (63%), **28** (40%).

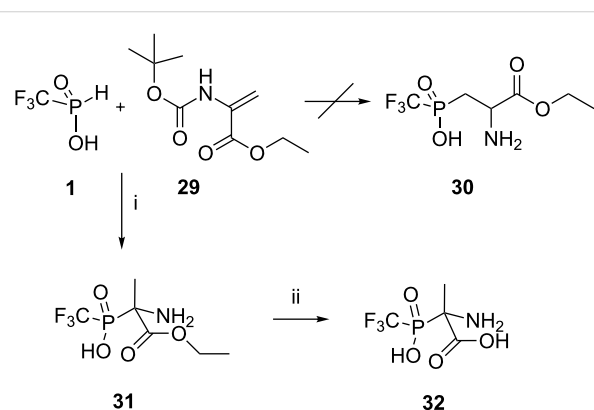

Scheme 8: Interaction of the acid **1** with ethyl 2-(*tert*-butoxycarbonylamino)acrylate (**29**). Reagents and conditions: i) an equimolar mixture of reagents, DME, rt, ³¹P NMR control, under argon atmosphere, 59%. ii) 5 N HCl, rt, 48 h, ion-exchange chromatography, H₂O, 54%.

Surprisingly, under the mild conditions of our experiment only the addition of acid **1** to the C=N double bond of the acrylic ester **29**, occurred to produce the *tertiary* phosphinyl derivative of alanine **31** in a satisfactory yield. Ester **31** was then hydrolyzed to give the free acid **32** in a moderate yield.

For the synthesis of the aspartic acid analogue **34**, a reaction between a mixture of the freshly prepared esters **3** and **4** and *N*-acetyl-protected aminoacrylic acid **33** was carried out [34] (Scheme 9).

It was thought that diester **3** might esterify aminoacrylic acid **33** [17,34] to produce ethyl 2-acetamidoacrylate and this compound in turn might add to monoester **4** to give the protected phosphinic acid analogue of aspartic acid **34**. Unfortunately, the only addition of **4** to the C=N double bond occurred similar to the previous transformation illustrated in Scheme 8. Insoluble in the reaction mixture phosphinic acid **37** was filtered off and characterized. ³¹P NMR analysis of filtrate showed the presence of adduct **35** and the decarboxylation product **36** in an approximate 1:10 ratio along with starting esters **3** and **4** and (trifluoromethyl)phosphonic acid (**10**) (<5%). Products **35** and **36** were separated by chromatography and characterized. Ester **36** was obtained as a mixture of two diastereoisomers, which are clearly seen by ¹H- and ¹⁹F NMR. This ester was then readily converted by acidolysis into the phosphinic acid analogue **37**, of *N*-acetylalanine, which was isolated in the 56% from acid **33**, and then transformed into free amino acid **14c**.

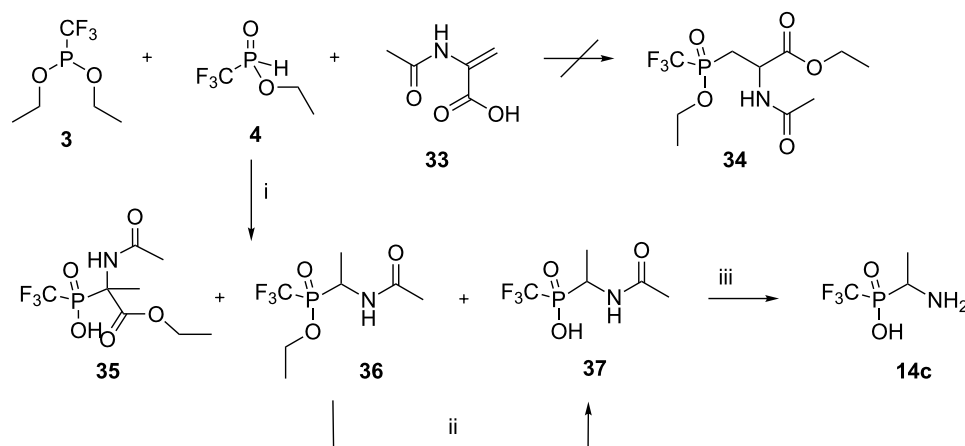

Scheme 9: Interaction of a mixture of the esters **3** and **4** with 2-acetamidoacrylic acid (**33**). Reagents and conditions: i) an equimolar mixture of **4** and **33** and 1.5 equiv of **3**, rt, ³¹P NMR control, under argon atmosphere, isolated yields: **35** (7%), **36** (40%) (diastereomeric ratio ~8:7), **37** (18%). ii) 5 N HCl, rt, 24 h, 95%. iii) 5 N HCl, in an ampoule, 130 °C, 8 h, 34%.

We have been able to prepare the isomeric aspartic acid analogue **41** with phosphorous α - to the amino group by the analogy with the published method [17,36]. The synthesis of phosphinic acid **41** was accomplished by addition of acid **1** to the activated C=C double bond of malonate **38** followed by hydrolysis and decarboxylation to generate adduct **39** in two steps (Scheme 10).

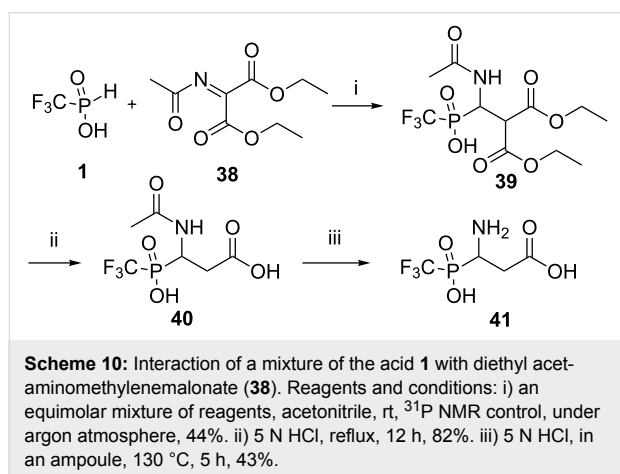

Conclusion

In conclusion, we have presented a variety of approaches to novel fluorinated (1-aminoalkyl)phosphinic acids starting from the appropriate fluorinated P–H compounds with CF_3 or CHF_2 groups attached to phosphorus. Three-component one pot Mannich-type reactions of $\text{CF}_3(\text{H})\text{P}(\text{O})(\text{OH})$ with dibenzylamine and aldehydes were investigated. Also nucleophilic addition of $\text{CF}_3(\text{H})\text{P}(\text{O})(\text{OH})$ or $\text{CHF}_2(\text{H})\text{P}(\text{O})(\text{OEt})$ to Schiff bases, aminoacrylates and acetaminomethylenemalonate have been used to prepare the title compounds.

Experimental

All reactions with P–H compounds were performed under an argon atmosphere. Flash chromatography was carried out using Merck silica gel 60 (230–400 mesh ASTM) and Aldrich ion-exchange resin Dowex WX-50. The NMR spectra were recorded on Varian VXR-300 or Bruker Avance DRX-500 spectrometers for ^1H (TMS); on a Bruker Avance DRX-500 spectrometer for ^{13}C {H} (TMS); on Varian Gemini-200 or Varian VXR-300 spectrometers for ^{19}F (CFCl_3) and for ^{31}P (H_3PO_4).

Synthesis of starting materials

(Trifluoromethyl)phosphinic acid (**1**). To an emulsion of water (3.2 g, 180 mmol) in anhydrous hexane (20 mL), cooled to -78°C CF_3PCl_2 [27] (16.5 g, 96.5 mmol) was added under stirring and the temperature was slowly raised to -10°C , when hydrolysis started. The reaction mixture was allowed to come to

0°C at such a rate to avoid a vigorous reaction (~ 3 h) and then to room temperature and stirring was continued overnight. Hexane was evaporated under reduced pressure and the residue was distilled to give **1** as a colorless liquid (10.84 g, 84%), bp 35°C (0.05 mm Hg); ^1H NMR (300 MHz, $\text{DMSO}-d_6$) δ_{H} 7.05 (dq, $^1J_{\text{HP}} = 638.9$ Hz, 1H, $^3J_{\text{HF}} = 4.2$ Hz, PH), 13.6 (1H, s, OH); ^{31}P NMR (121 MHz) δ_{P} 6.1 (dq, $^1J_{\text{PH}} = 639$ Hz, $^2J_{\text{PF}} = 82$ Hz); ^{19}F NMR (188 MHz) δ_{F} -76.8 (dd, $^2J_{\text{FP}} = 82$ MHz, $^3J_{\text{FH}} = 4$ Hz). **Caution:** Safety precautions are necessary, because CF_3PCl_2 reacts violently with air. Care must be taken not to warm the reaction system rapidly, because rapid volatilization of gaseous HCl will be accompanied by carrying off CF_3PCl_2 , which can inflame.

(Difluoromethyl)phosphinic acid (**6**). A mixture of **5** [18] (8 g, 56 mmol) and NaHCO_3 (7 g, 83 mmol) in ether (50 mL) was stirred overnight at room temperature to produce a bulky precipitate of $\text{CHF}_2\text{P}(\text{O})\text{H}(\text{O})^-\text{Na}^+$ [^{31}P NMR (121 MHz, H_2O): δ_{P} 11.9 (dtd, $^1J_{\text{PH}} = 570$ Hz, $^2J_{\text{PF}} = 87$ Hz, $^2J_{\text{PH}} = 25$ Hz)]. This precipitate was filtered, thoroughly washed with ether, solved in water (25 mL) and passed down an ion-exchange column. Water from the resulting solution was evaporated under reduced pressure and the residue was kept in vacuo (0.05 mmHg) for 24 h at room temperature to give **6** as a viscous colorless undistillable liquid (7.19 g, 78%); Anal. calcd for $\text{CH}_3\text{F}_2\text{O}_2\text{P}$: C, 10.35; H, 2.61; P, 26.71; found: C, 10.48; H, 2.70; P, 26.59; ^1H NMR (300 MHz, $\text{DMSO}-d_6$) δ_{H} 6.15 (tdd, $^2J_{\text{HF}} = 48.6$ Hz, $^2J_{\text{HP}} = 24.5$ Hz, $^3J_{\text{HH}} = 1.5$ Hz, 1H, CHF_2), 6.9 (dm, $^1J_{\text{HP}} = 566.5$ Hz, 1H, PH), 12.7 (s, 1H, OH); ^{31}P NMR (121 MHz) δ_{P} 12.1 (dtd, $^1J_{\text{PH}} = 566$ Hz, $^2J_{\text{PF}} = 86$ Hz, $^2J_{\text{PH}} = 25$ Hz); ^{19}F NMR (188 MHz) δ_{F} 9.6 (dd, $^2J_{\text{FP}} = 86$ Hz, $^2J_{\text{FH}} = 49$ Hz).

Three-component reactions

The general procedure for the condensation of the acid 1 with dibenzylamine and aldehydes (I). An equimolar mixture of **1** (2.68 g, 20 mmol) and dibenzylamine (3.94 g, 20 mmol) in 1 N HCl (20 mL) was heated at 80°C under stirring. In the course of ~ 1 h aldehydes **12a,b** were added with a syringe and the reaction mixture was kept at this temperature for additional 1 h. The resulting mixture was left overnight at room temperature to produce the precipitate, which was filtered, washed with acetone–water (10:1) and dried to afford **13a** or **13b**. The filtrate was evaporated to the dryness, the residue was triturated with acetone–water (10:1) to give an additional quantity of **13a,b**.

[(Dibenzylamino)methyl](trifluoromethyl)phosphinic acid (**13a**). Following the general procedure (I) using 3.2 mL of 37% aqueous formaldehyde solution (20 mmol) **13a** was obtained as a white solid (3.57 g, 52%), mp 229°C ; Anal. calcd for

$C_{16}H_{17}F_3NO_2P$: C, 55.98; H, 4.99; N, 4.08; found: C, 55.69; H, 5.28; N, 4.15; 1H NMR (300 MHz, DMSO- d_6) δ_H 2.94 (d, $^2J_{HP}$ = 9.3 Hz, 2H, CH_2P), 4.45 (s, 4H, CH_2Ph), 7.47–7.59 (m, 10H, $H_{arom.}$); ^{31}P NMR (121 MHz) δ_P 3.8 (qt, $^2J_{PF}$ = 81 Hz, $^2J_{PH}$ = 9 Hz); ^{19}F NMR (188 MHz) δ_F -73.8 (d, $^2J_{FP}$ = 81 Hz).

The general procedure for N-deprotection of compounds with N-Bn function under the catalytic hydrogenation conditions (II). To a solution of compounds, containing N-Bn fragment (5 mmol) in ethanol (10 mL) 10% Pd/C (0.05 g) was added, and the mixture was hydrogenated at room temperature and normal pressure. After ~3 h the precipitation commenced, and water (5 mL) was added to dissolve this precipitate. The hydrogenation was then continued with a fresh portion of the catalyst (0.05 g) for a further 3 h. Last procedure was repeated whenever necessary and the reaction was left overnight. To the resulting mixture water was added until a white solid was fully dissolved, and the catalyst was then filtered off. The filtrate was evaporated to dryness; the residue was dissolved in acetone and allowed to stand at 5 °C until complete precipitation. The formed solid was filtered, washed with acetone and dried to give compounds with the free NH_2 function.

(Aminomethyl)(trifluoromethyl)phosphinic acid (**14a**). Following the general procedure (II) **14a** was obtained as a white powder (0.78 g, 95%); mp 192 °C; Anal. calcd for $C_2H_5F_3NO_2P$: C, 14.73; H, 3.09; N, 8.59; found: C, 14.69; H, 2.89; N, 8.42; 1H NMR (300 MHz, D_2O) δ_H 3.14 (d, $^2J_{HP}$ = 11.4 Hz); ^{31}P NMR (121 MHz) δ_P 12.2 (qt, $^2J_{PF}$ = 96 Hz, $^2J_{PH}$ = 11 Hz); ^{19}F NMR (188 MHz) δ_F -76.1 (d, $^2J_{FP}$ = 96 Hz); ^{13}C NMR (125 MHz) δ_C 34.8 (d, $^1J_{CP}$ = 105.6 Hz, CH_2), 122.1 (qd, $^1J_{CF}$ = 316.0 Hz, $^1J_{CP}$ = 179.9 Hz, CF_3).

Hydrophosphinylation of azomethines

The general procedure for the addition of acid 1 and ester 5 to substrates with the C=N double bond (III). An equimolar mixture of an imine and **1** or **5** in DME (10 mL for 5 mmol) was stirred at room temperature under ^{31}P NMR control until the ^{31}P signals of starting P-H compounds disappeared. Sometimes an appropriate adduct precipitated and this was filtered off. The reaction mixture or the filtrate was then evaporated to dryness and the residue was worked up as described below for the individual substances.

Ethyl [(benzylamino)(phenyl)methyl](difluoromethyl)phosphinate (**18b**, Table 2, entry 2). Following the general procedure (III) a crude solid, obtained from **5** (0.49 g, 3.4 mmol) and **16b** (0.68 g, 3.4 mmol) was extracted with boiling hexane (3 × 30 mL), this extract was evaporated to the dryness to afford **18b** as a yellowish solid (0.67 g, 58%); mp 85–93 °C, as a mixture of two diastereoisomers in an approximately 1:3.5 ratio due

to 1H NMR (300 MHz, $CDCl_3$) δ_H 0.97 (t, $^3J_{HH}$ = 7.6 Hz, 0.7H, CH_3 , *minor isomer*), 1.25 (t, $^3J_{HH}$ = 7.6 Hz, 2.3H, CH_3 , *major isomer*), 2.17 (br s, 1H, NH), 3.46 (d, J_{AB} = 12.6 Hz, 0.22H, CH_2Ph , *minor isomer*), 3.51 (d, J_{AB} = 12.6 Hz, 0.77H, CH_2Ph , *major isomer*), 3.78 (d, J_{AB} = 12.6 Hz, 1H, CH_2Ph), 3.9 (dm, $^2J_{HP}$ = 16.9 Hz, 0.22H, PCH , *minor isomer*), 4.08 (d, $^2J_{HP}$ = 17.1 Hz, 0.8H, PCH , *major isomer*), 4.1–4.25 (m, 2H, OCH_2), 5.88 (td, $^2J_{HF}$ = 49.2 Hz, $^2J_{HP}$ = 27.8 Hz, 0.8H, CHF_2 , *major isomer*), 6.25 (td, $^2J_{HF}$ = 49.3 Hz, $^2J_{HP}$ = 27.6 Hz, 0.2H, CHF_2 , *minor isomer*), 7.15–7.40 (m, 10H, $H_{arom.}$); ^{31}P NMR (81 MHz) δ_P 30.8 (m); ^{19}F NMR (188 MHz) δ_F -132 to -140.5 (complex multiplet). To the viscous residue after extraction of **18b** water (20 mL) was added, resulting solution was decolorized with activated charcoal, filtrated and allowed to stand at 5 °C until crystallization completed, producing [(benzylamino)-(phenyl)methyl](difluoromethyl)phosphinic acid (**19b**) as a white solid (0.32 g, 30%); mp 247 °C; Anal. calcd for $C_{15}H_{16}F_2NO_2P$: C, 57.88; H, 5.18; N, 4.50; found: C, 57.91; H, 5.04; N, 4.48; 1H NMR (300 MHz, DMSO- d_6) δ_H 3.95 (d, J_{AB} = 12.9 Hz, 1H, CH_2Ph), 4.04 (d, $^2J_{HP}$ = 10.2 Hz, 1H, PCH), 4.10 (d, J_{AB} = 12.9 Hz, 1H, CH_2Ph), 5.63 (td, $^2J_{HF}$ = 49.2 Hz, $^2J_{HP}$ = 21.9 Hz, 1H, CHF_2), 7.30–7.42 (m, 10H, $H_{arom.}$); ^{31}P NMR (81 MHz) δ_P 13.4 (tm, $^2J_{PF}$ = 68 Hz). An additional quantity of **19b** was obtained by hydrolysis of **18b** (0.67 g, 2 mmol) with 1N HCl (15 mL) at room temperature until the starting ester has dissolved. The resulting solution was evaporated to dryness at reduced pressure and the residue was recrystallized from water to give **19b** (0.6 g, 97%). The overall yield of **19b** is 0.92 g (87%).

See Supporting Information for details of the syntheses, characteristics and NMR spectra of all new compounds.

Supporting Information

Experimental procedures and full characterization data for all new compounds including elemental analysis and 1H , ^{31}P , ^{19}F and ^{13}C NMR are provided in the Supporting Information.

Supporting Information File 1

Experimental procedures, elemental analysis and NMR data.

[<http://www.beilstein-journals.org/bjoc/content/supplementary/1860-5397-10-66-S1.pdf>]

Supporting Information File 2

NMR spectra of the most typical compounds.

[<http://www.beilstein-journals.org/bjoc/content/supplementary/1860-5397-10-66-S2.pdf>]

Supporting Information File 3

NMR spectra of the most typical compounds
(continuation).[\[http://www.beilstein-journals.org/bjoc/content/supplementary/1860-5397-10-66-S3.pdf\]](http://www.beilstein-journals.org/bjoc/content/supplementary/1860-5397-10-66-S3.pdf)

References

- Kukhar, V. P.; Hudson, H. R., Eds. *Aminophosphonic and Aminophosphinic Acids: Chemistry and Biological Activity*; John Wiley & Sons, Ltd: Chichester, U.K., 2000.
- Ordóñez, M.; Viveros-Ceballos, J. L.; Catiuela, C.; Arizpe, A. *Curr. Org. Synth.* **2012**, *9*, 310–341. doi:10.2174/157017912801270595
- Ordóñez, M.; Sayago, F. J.; Catiuela, C. *Tetrahedron* **2012**, *68*, 6369–6412. doi:10.1016/j.tet.2012.05.008
- Kudzin, Z. H.; Kudzin, M. H.; Drabowicz, J.; Stevens, C. V. *Curr. Org. Chem.* **2011**, *15*, 2015–2071. doi:10.2174/138527211795703612
- Palacios, F.; Alonso, C.; de los Santos, J. M. *Chem. Rev.* **2005**, *105*, 899–932. doi:10.1021/cr040672y
- Fields, S. C. *Tetrahedron* **1999**, *55*, 12237–12273. doi:10.1016/S0040-4020(99)00701-2
- Welch, J. T.; Eswarakrishnan, S., Eds. *Fluorine in Bioorganic Chemistry*; John Wiley & Sons, Inc.: New York, 1991.
- Hiyama, T., Ed. *Organofluorine Compounds. Chemistry and Applications*; Springer: Berlin, 2000.
- Banks, R. E.; Smart, B. E.; Tatlow, J. C., Eds. *Organofluorine Chemistry. Principles and Commercial Applications*; Plenum: New York, 1994.
- Romanenko, V. D.; Kukhar, V. P. *Chem. Rev.* **2006**, *106*, 3868–3935. doi:10.1021/cr051000q
- Bayer, E.; Gugel, K. H.; Hägele, M.; Hagenmaier, M.; Jessipow, S.; König, A. W.; Zähler, H. *Helv. Chim. Acta* **1972**, *55*, 224–239. doi:10.1002/hlca.19720550126
- Mater, L. *Phosphorus Sulfur Relat. Elem.* **1983**, *14*, 295–322. doi:10.1080/03086648308073262
- Popoff, L. C.; Huber, L. K.; Block, B. P.; Morton, P. D.; Riordan, R. P. *J. Org. Chem.* **1963**, *28*, 2898–2900. doi:10.1021/jo01045a516
- Oleksyszyn, J.; Tyka, R.; Mastalerz, P. *Synthesis* **1978**, 479–480. doi:10.1055/s-1978-24792
- Wasielewski, C.; Antczak, K.; Rachon, J. *Pol. J. Chem.* **1978**, *52*, 1315. *Chem. Abstr.* **1978**, *89*, 163655u.
- Subotkowski, W.; Tyka, R.; Mastalerz, P. *Pol. J. Chem.* **1980**, *54*, 503. *Chem. Abstr.* **1980**, *94*, 30845n.
- Soroka, M.; Mastalerz, P. *Rocz. Chem.* **1976**, *50*, 661. *Chem. Abstr.* **1976**, *80*, 121058k.
- Froestl, W.; Mickel, S. J.; Hall, R. G.; von Sprecher, G.; Strub, D.; Bauman, P. A.; Brugger, F.; Gentsch, C.; Jaekel, J.; Olpe, H.-R.; Rihs, G.; Vassout, A.; Waldmeier, P. C.; Bittiger, H. *J. Med. Chem.* **1995**, *38*, 3297–3312. doi:10.1021/jm00017a015
- Kabachnic, M. I.; Medvedev, T. Y. *Dokl. Akad. Nauk SSSR* **1952**, *83*, 689. *Chem. Abstr.* **1952**, *46*, 421c.
- Fields, E. K. *J. Am. Chem. Soc.* **1952**, *74*, 1528–1531. doi:10.1021/ja01126a054
- Moedritzer, K.; Irani, R. R. *J. Org. Chem.* **1966**, *31*, 1603–1607. doi:10.1021/jo01343a067
- Redmore, D. In *The chemistry of P-C-N systems*; Griffith, E. J.; Graison, M., Eds.; Topics in Phosphorus Chemistry, Vol. 8; John Wiley & Sons, Inc.: New York, 1976; pp 515–585.
- Emelús, H. J.; Haszeldine, R. N.; Paul, R. C. *J. Chem. Soc.* **1955**, 563–574. doi:10.1039/JR9550000563
- Maslennikov, I. G.; Lavrent'ev, A. N.; Hovanskaya, N. V.; Lebedev, V. B.; Sochilin, E. G. *Zh. Obshch. Khim.* **1979**, *49*, 1498–1500. *J. Gen. Chem. USSR* **1979**, *49*, 1307–1309; *Chem. Abstr.* **1979**, *91*, 140924h.
- Golovanov, A. V.; Maslennikov, I. G.; Lavrent'ev, A. N. *Zh. Obshch. Khim.* **1988**, *58*, 1525–1529. *J. Gen. Chem. USSR* **1988**, *58*, 1357–1360; *Chem. Abstr.* **1988**, *108*, 21973h.
- Bennet, F. W.; Emelús, H. J.; Haszeldine, R. N. *J. Chem. Soc.* **1953**, 1565–1571. doi:10.1039/JR9530001565
- Volbach, W.; Ruppert, I. *Tetrahedron Lett.* **1983**, *24*, 5509–5512. doi:10.1016/S0040-4039(00)94125-X
- Pudovik, A. N.; Konovalova, I. V. *Synthesis* **1979**, 81–96. doi:10.1055/s-1979-28566
- Mahmood, T.; Shreeve, J. M. *Inorg. Chem.* **1986**, *25*, 3128–3131. doi:10.1021/ic00238a006
- Blackburn, G. M.; Brown, D.; Martin, S. J.; Parratt, M. J. *J. Chem. Soc., Perkin Trans. 1* **1987**, 181–186. doi:10.1039/p19870000181
- Vidal, J.; Guy, L.; Sterin, S.; Collet, A. *J. Org. Chem.* **1993**, *58*, 4791–4793. doi:10.1021/jo00070a007
- Jung, M. E.; Shishido, K.; Light, L.; Davis, L. *Tetrahedron Lett.* **1981**, *22*, 4607–4610. doi:10.1016/S0040-4039(01)82993-2
- Poisel, H.; Schmidt, U. *Chem. Ber.* **1975**, *108*, 2547–2553. doi:10.1002/cber.19751080809
- Chambers, J. R.; Isbell, A. F. *J. Org. Chem.* **1964**, *29*, 832–836. doi:10.1021/jo01027a015
- Ramesh, R.; De, K.; Chandrasekaran, S. *Tetrahedron* **2007**, *63*, 10534–10542. doi:10.1016/j.tet.2007.07.094
- Merret, J. H.; Spurden, W. C.; Thomas, W. A.; Tong, B. P.; Whitcombe, I. W. A. *J. Chem. Soc., Perkin Trans. 1* **1988**, 61–67. doi:10.1039/P19880000061

License and Terms

This is an Open Access article under the terms of the Creative Commons Attribution License (<http://creativecommons.org/licenses/by/2.0>), which permits unrestricted use, distribution, and reproduction in any medium, provided the original work is properly cited.

The license is subject to the *Beilstein Journal of Organic Chemistry* terms and conditions: (<http://www.beilstein-journals.org/bjoc>)

The definitive version of this article is the electronic one which can be found at: [doi:10.3762/bjoc.10.66](http://dx.doi.org/10.3762/bjoc.10.66)

Syntheses of fluorooxindole and 2-fluoro-2-arylacetic acid derivatives from diethyl 2-fluoromalonate ester

Antal Harsanyi¹, Graham Sandford^{*1}, Dmitri S. Yufit²
and Judith A.K. Howard²

Full Research Paper

Open Access

Address:

¹Department of Chemistry, Durham University, South Road, Durham, DH1 3LE, UK and ²Chemical Crystallography, Department of Chemistry, Durham University, South Road, Durham, DH1 3LE, UK

Email:

Graham Sandford^{*} - graham.sandford@durham.ac.uk

^{*} Corresponding author

Keywords:

fluorinated building blocks; fluoroarylacetic acid; fluoromalonate; fluorooxindole; organo-fluorine; selective fluorination

Beilstein J. Org. Chem. **2014**, *10*, 1213–1219.

doi:10.3762/bjoc.10.119

Received: 10 January 2014

Accepted: 16 May 2014

Published: 22 May 2014

This article is part of the Thematic Series "Organo-fluorine chemistry III".

Guest Editor: D. O'Hagan

© 2014 Harsanyi et al; licensee Beilstein-Institut.

License and terms: see end of document.

Abstract

Diethyl 2-fluoromalonate ester is utilised as a building block for the synthesis of 2-fluoro-2-arylacetic acid and fluorooxindole derivatives by a strategy involving nucleophilic aromatic substitution reactions with *ortho*-fluoronitrobenzene substrates followed by decarboxylation, esterification and reductive cyclisation processes.

Introduction

Since 1954, when Fried and Sabo observed that the incorporation of a fluorine atom into a corticosteroid derivative led to valuable enhanced biological activity [1], a growing number of commercially significant life science products, which owe their activity to the presence of fluorine atoms within their structures, have developed. Fluorine incorporation can lead, for example, to enhanced bioavailability, metabolic stability and lipophilicity of the organic system and these properties are exploited in a number of commercially valuable drugs including Ciprofloxacin, Lipitor and Voriconazole [2-6].

Given the very small number of fluorinated systems available from nature [7-9], in essence all organic molecules bearing carbon-fluorine bonds are 'man-made'. Syntheses rely either on

the construction of carbon-fluorine bonds using a fluorinating agent ('late-stage' fluorination) or the application of polyfunctional fluorine-containing small molecule building blocks ('early stage' fluorination) which may be employed in further transformations involving all the reactions and techniques available to synthetic organic chemists [10-13]. Of course, the success of an 'early stage' fluorination approach depends on the availability of a range of appropriately functionalised, fluorinated building blocks and the establishment of corresponding reactivity profiles [14]. However, it does not necessarily follow that reactions for which regio- and stereoselectivity profiles are well established for hydrocarbon systems will be similar to those for corresponding selectively fluorinated systems and, indeed, this is often not the case [15].

The use of 1,3-diketone, 1,3-ketoester and 1,3-diester derivatives in retrosynthetic planning is widespread in general organic chemistry and numerous terpenes, heterocycles and steroids originate from such simple yet synthetically versatile substrates [16–19]. In contrast, despite the availability of synthetic procedures for the preparation of various 2-fluoro-1,3-dicarbonyl systems [20–27], there is, surprisingly, only a relatively limited number of publications that report the use of such potentially useful fluorinated building blocks for the synthesis of more structurally sophisticated selectively fluorinated systems. For example, 2-fluoromalonate esters have been used for the preparation of various α -fluorocarboxylic acids [28–32], heterocycles, such as fluoropyrimidine [33] and quinolone [34] derivatives, alkylated [35] and Michael addition [36–40] products, providing an indication of the potential uses and opportunities available for the synthesis of fluoro-organic products from fluoromalonate precursors.

As part of a wider research programme aimed at developing routes for the synthesis of selectively fluorinated molecules using elemental fluorine for the key construction of the carbon–fluorine bond by complementary direct selective direct fluorination [41–44], continuous flow [45–49] and building block [50] strategies, in this paper, we describe nucleophilic aromatic substitution reactions of carbanions derived from diethyl 2-fluoromalonate ester as the first stage in the synthesis of fluoroacetic acid and fluoroindole systems. While related palladium catalysed coupling processes between aryl bromides and diethyl 2-fluoromalonate have been described [51], reactions involving nucleophilic aromatic substitution between fluoromalonate systems [52] and appropriate aryl substrates have not been reported previously. Recently, various routes to fluoroindoles have been discussed involving enantioselective fluorination of appropriate oxindole substrates by electrophilic fluorinating agents [53–62] or DAST [63] providing an indication of the importance of fluoroindoles for medicinal chemistry applications.

Results and Discussion

Reactions of carbanions generated by the addition of sodium hydride to a solution of diethyl 2-fluoromalonate (**1**) in DMF with *ortho*-fluoronitrobenzene (**2a**) led to the efficient displacement of fluorine by a nucleophilic aromatic substitution process

to provide diester **3** in good yield (Scheme 1). Displacement of fluorine from *ortho*-fluoronitrobenzene was quantitative as measured by ^{19}F NMR spectroscopy of the crude reaction mixture and the structure of isolated diester **3** was confirmed by X-ray crystallography (Figure 1).

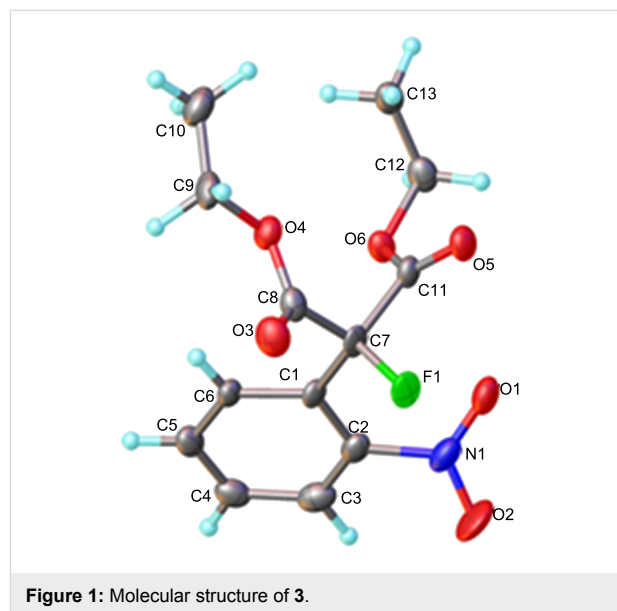

In initial experiments, decarboxylation of **3** by reaction with potassium hydroxide gave good yields of the corresponding 2-fluoro-2-arylacetic acid **4a**. However, in subsequent experiments, we found that further purification of the diester **3** after the initial $\text{S}_{\text{N}}\text{Ar}$ step was not necessary and decarboxylation of crude diester **3** gave **4a** very efficiently. Consequently, in all analogous experiments (Table 1), crude product diesters of type **3** were isolated and used without further purification, allowing the ready synthesis of a range of arylfluoroacetic acid derivatives **4a–f** (Table 1). Structures **4a–f** were confirmed by NMR techniques and, in particular, a doublet located at -190 ppm ($^2J_{\text{HF}} = 50$ Hz) in the ^{19}F NMR spectra assigned to the CFH resonances and the corresponding doublets observed at ~ 6 ppm in the ^1H NMR spectra, are diagnostic for the structures proposed.

A nitro group *ortho* to a fluorine atom on the aryl ring is necessary under the present conditions to achieve full conversion of

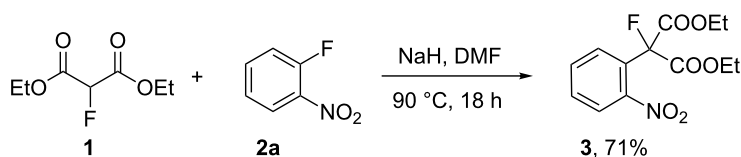

Scheme 1: $\text{S}_{\text{N}}\text{Ar}$ reaction of 2-fluoronitrobenzene (**2a**) with diethyl 2-fluoromalonate (**1**).

Table 1: S_NAr reactions using fluoromalonate derivatives.

Fluoronitroaryl 2	Fluoroarylacetic acid 4	Yield
 2a	 4a	62%
 2b	 4b	77%
 2c	 4c	83%
 2d	 4d	56%
 2e	 4e	60%
 2f	 4f	86%

the starting fluoroarene. In related experiments, we found that a *para*-trifluoromethyl group is not sufficiently activating for reaction to occur whilst *para*-fluoronitrobenzene gave a complex mixture of unidentified products, most probably derived from competing benzyne formation.

This efficient methodology complements reported processes for the synthesis of various biologically active 2-fluoro-2-phenylacetic acids [64] which may be prepared using electrophilic fluorination of enolate esters [64–66], deoxofluorination [67–69] nucleophilic [70] and electrochemical fluorination [71,72] strategies.

Attempts to prepare 2-fluoro-2-(2,4-dinitrophenyl)acetic acid by an analogous process led to the isolation of a benzyl fluoride derivative **5**, after evaporation of toluene and purification by column chromatography in 61% yield. The two consecutive decarboxylation reactions reflect the greater stability of the benzylic carbanion formed on loss of carbon dioxide from this system (Scheme 2).

With the series of 2-fluorophenylacetic acids in hand, we attempted the reduction of the nitro group in **4a** using sodium dithionite, adapting reaction conditions similar to those described in the literature for the synthesis of biologically active

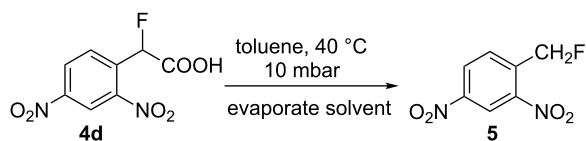

Scheme 2: Synthesis of benzyl fluoride derivative 5.

system MaxiPost [63]. However, very low isolated yields of the cyclised product were obtained, presumably because of the high solubility of the amino acid intermediate in the aqueous reaction mixture and the well-established difficulty of direct amide bond formation processes. Consequently, before carrying out the nitro group reduction and amide forming cyclisation reactions, the acids **4a–e** were transformed to the corresponding methyl esters **6a–e** by stirring a mixture of the acid in hydrochloric acid and methanol (Table 2). The structure of **6a**

Table 2: Synthesis of methyl ester derivatives.

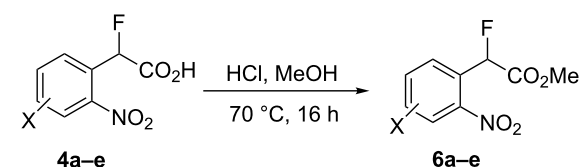

Fluoroacetic acid 4	Methyl ester 6	Yield
		88%
		98%
		97%
		65%
		98%

was confirmed unambiguously by X-ray crystallography (Figure 2) and all other methyl esters **6b–e** were characterised by comparison with appropriate NMR data obtained for **6a**.

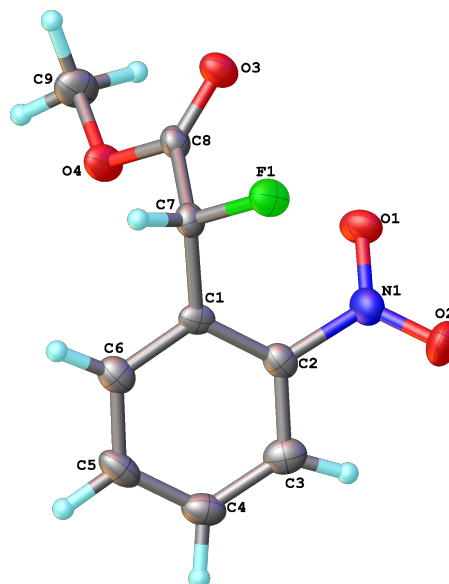
Figure 2: Molecular structure of methyl ester **6a**.

However, corresponding attempted esterification of the salt **4f** with HCl in methanol gave 2-fluoromethyl-3-nitropyridine (**7**) in 68% yield (Scheme 3) after purification of the crude material by column chromatography and the structure was confirmed by X-ray analysis (Figure 3). In this case competing decarboxylation, rather than esterification, reflects the greater stabilisation of the carbanion system formed upon decarboxylation for this system.

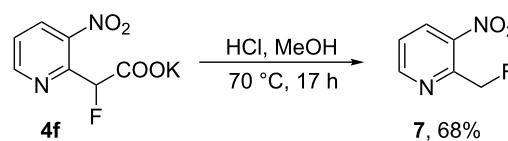
Scheme 3: Synthesis of pyridyl fluoride **7**.

Reductive cyclization of methyl esters **6a–e** using sodium dithionite provided fluorooxindoles **8a–e** in acceptable yield after isolation by column chromatography (Table 3). In the ^1H NMR spectrum, the characteristic CHF doublet located at 5.7 ppm ($^2J_{\text{HF}} = 51$ Hz) for the fluorooxindole systems **8** are 0.9 ppm upfield from the corresponding CHF resonances of the arylfluoroacetic esters **6a–e** and, additionally, a broad NH singlet was detected at 9.0 ppm. The chemical shift of the doublet (-194.8 ppm) in the ^{19}F NMR spectrum of fluorooxind-

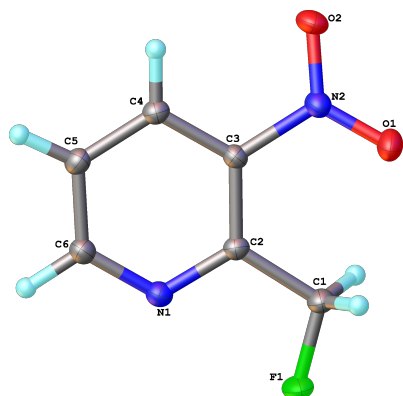

Figure 3: Molecular structure of 7.

doles **8a–e** is also observed 10 ppm upfield from the fluorine resonance of the starting esters **6a–e**.

Conclusion

Diethyl 2-fluoromalonate ester can be used as a highly effective fluorinated building block for the synthesis of various polyfunctional 2-fluoroacetic acid and 3-fluorooxindole systems. Fluorooxindoles are relatively rare fluorinated heterocyclic systems, even though several derivatives have useful biological activity, and current literature syntheses only involve fluorination of appropriate hydroxy and oxindole substrates. The strategy described here provides complementary building block syntheses from readily available fluorinated starting materials, further demonstrating the viability of using fluorinated dicarbonyl systems for the synthesis of more structurally sophisticated fluorinated derivatives.

Table 3: Synthesis of 3-fluorooxindoles.

Methyl ester 6	Fluorooxindole 8	Yield
 6a	 8a	32%
 6b	 8b	82%
 6c	 8c	57%
 6d	 8d	0%
 6e	 8e	30%

Supporting Information

Supporting Information File 1

Experimental procedures.

[<http://www.beilstein-journals.org/bjoc/content/supplementary/1860-5397-10-119-S1.pdf>]

Supporting Information File 2

NMR spectra.

[<http://www.beilstein-journals.org/bjoc/content/supplementary/1860-5397-10-119-S2.pdf>]

Supporting Information File 3

X-ray crystallographic data.

[<http://www.beilstein-journals.org/bjoc/content/supplementary/1860-5397-10-119-S3.cif>]

References

- Fried, J.; Sabo, E. F. *J. Am. Chem. Soc.* **1954**, *76*, 1455–1456. doi:10.1021/ja01634a101
- Müller, K.; Faeh, C.; Diedrich, F. *Science* **2007**, *317*, 1881–1886. doi:10.1126/science.1131943
- Ojima, I., Ed. *Fluorine in Medicinal Chemistry and Chemical Biology*; Wiley-Blackwell: Oxford, 2009.
- Purser, S.; Moore, P. R.; Swallow, S.; Gouverneur, V. *Chem. Soc. Rev.* **2008**, *37*, 320–330. doi:10.1039/b610213c
- Isanbor, C.; O'Hagan, D. *J. Fluorine Chem.* **2006**, *127*, 303–319. doi:10.1016/j.jfluchem.2006.01.011
- Kirk, K. L. *J. Fluorine Chem.* **2006**, *127*, 1013–1029. doi:10.1016/j.jfluchem.2006.06.007
- Gribble, G. W. *Chem. Soc. Rev.* **1999**, *28*, 335–346. doi:10.1039/a900201d
- Hall, R. J. *New Phytol.* **1972**, *71*, 855–871. doi:10.1111/j.1469-8137.1972.tb01965.x

9. O'Hagan, D.; Schaffrath, C.; Cobb, S. L.; Hamilton, J. T. G.; Murphy, C. D. *Nature* **2002**, *416*, 279. doi:10.1038/416279a
10. Baasner, B.; Hagemann, H.; Tatlow, J. C. *Houben-Weyl Organofluorine Compounds*; Thieme: Stuttgart, 2000; Vol. E10a.
11. Chambers, R. D. *Fluorine in Organic Chemistry*; Blackwell: Oxford, 2004.
12. Uneyama, K. *Organofluorine Chemistry*; Blackwell: Oxford, 2006. doi:10.1002/9780470988589
13. Liang, T.; Neumann, C. N.; Ritter, T. *Angew. Chem., Int. Ed.* **2013**, *52*, 8214–8264. doi:10.1002/anie.201206566
14. Percy, J. M. *Top. Curr. Chem.* **1997**, *199*, 131–195. doi:10.1007/3-540-69197-9_4
15. Seebach, D. *Angew. Chem., Int. Ed. Engl.* **1990**, *29*, 1320–1367. doi:10.1002/anie.199013201
16. Warren, S. *Designing Organic Syntheses: A Programmed Introduction to the Synthron Approach*; John Wiley and Sons: New York, 1978.
17. Warren, S.; Wyatt, P. *Organic Synthesis: The Disconnection Approach*, 2nd ed.; John Wiley and Sons: Chichester, 2008.
18. Wyatt, P.; Warren, S. *Organic Synthesis: Strategy and Control*, 2nd ed.; John Wiley and Sons: Chichester, 2007.
19. Corey, E. J.; Cheng, X.-M. *The logic of chemical synthesis*; John Wiley and Sons: New York, 1995.
20. Chambers, R. D.; Hutchinson, J.; Thomson, J. J. *Fluorine Chem.* **1996**, *78*, 165–166. doi:10.1016/0022-1139(96)03422-7
21. Chambers, R. D.; Fox, M. A.; Holling, D.; Nakano, T.; Okazoe, T.; Sandford, G. *Chem. Eng. Technol.* **2005**, *28*, 344–352. doi:10.1002/ceat.200407123
22. Chambers, R. D.; Hutchinson, J. J. *Fluorine Chem.* **1998**, *92*, 45–52. doi:10.1016/S0022-1139(98)00254-1
23. Müh, T.; Fiedler, P.; Weintritt, H.; Westerkamp, W.; Reinecke, A. Method for producing alpha fluoromalononic acid dialkyl esters. W.O. Patent WO2002016304, Feb 28, 2002.
24. Günther, A.; Weintritt, H.; Böhm, S. Method for producing a-fluoromalononic acid dialkyl esters. W.O. Patent WO2005019154, March 3, 2005.
25. Braun, M.; Brosch, C. Production of fluorine compounds. W.O. Patent WO2002060838, Aug 8, 2002.
26. Ishikawa, N.; Takaoka, A. *Chem. Lett.* **1981**, *10*, 107–110. doi:10.1246/cl.1981.107
27. Ishikawa, N.; Takaoka, A.; Ibrahim, M. K. *J. Fluorine Chem.* **1984**, *25*, 203–212. doi:10.1016/S0022-1139(00)80949-5
28. Miller, T. A.; Sloman, D. L.; Stanton, M. G.; Wilson, K. J.; Witter, D. J. Fluorinated arylamide derivatives. W.O. Patent WO2007087129, Aug 2, 2007.
29. Close, J.; Heidebrecht, R. W.; Kattar, S.; Miller, T. A.; Sloman, D.; Stanton, M. G.; Tempest, P.; Witter, D. J. Histone deacetylase inhibitors with aryl-pyrazolyl motifs. W.O. Patent WO2007055941, May 18, 2007.
30. Hubbs, J. L.; Mampreian, D. M.; Methot, J. L.; Miller, T. A.; Otte, K. M.; Siliphaivanh, P.; Sloman, D. L.; Stanton, M. G.; Wilson, K. J.; Witter, D. J. Benzothiophene derivatives. W.O. Patent WO2006115845, Nov 2, 2006.
31. Bressi, J. C.; Chu, S.; Erickson, P.; Komandla, M.; Kwok, L.; Lawson, J. D.; Stafford, J. A.; Wallace, M. B.; Zhang, Z.; Das, J. cMET inhibitors. W.O. Patent WO2010019899, Feb 18, 2010.
32. Leonardi, A.; Riva, C.; Tavecchia, P.; Sironi, G. Aldosterone receptor antagonists. W.O. Patent WO2007025780, March 8, 2007.
33. Bergmann, E. D.; Cohen, S.; Shahak, I. *J. Chem. Soc.* **1959**, 3286–3289. doi:10.1039/jr9590003286
34. Brickner, S. J.; Chen, J. M.; Li, Z. B.; Marfat, A.; Mitton-Fry, M. J.; Plotkin, M. A.; Reilly, U. D.; Subramanyam, C.; Zhang, Z.; Robinson, S. Substituted heterocyclic derivatives and their pharmaceutical use and compositions. U.S. Patent US20080280879, Nov 13, 2008.
35. Polla, M. O.; Tottie, L.; Nordén, C.; Linschoten, M.; Müsil, D.; Trumpp-Kallmeyer, S.; Aukrust, I. R.; Ringom, R.; Holm, K. H.; Neset, S. M.; Sandberg, M.; Thurmond, J.; Yu, P.; Hategan, G.; Anderson, H. *Bioorg. Med. Chem.* **2004**, *12*, 1151–1175. doi:10.1016/j.bmc.2003.12.039
36. Kim, D.-Y.; Kim, S.-M.; Koh, K.-O.; Mang, J.-Y.; Lee, K.-S. *Bull. Korean Chem. Soc.* **2003**, *24*, 1425–1426. doi:10.5012/bkcs.2003.24.10.1425
37. Cho, M.-J.; Cho, M.-G.; Huh, S.-C.; Kim, S.-M.; Lee, K.-s.; Koh, K.-O.; Mang, J.-Y.; Kim, D.-Y. *Bull. Korean Chem. Soc.* **2006**, *27*, 857–862. doi:10.5012/bkcs.2006.27.6.857
38. Kang, S.-H.; Kim, D.-Y. *Bull. Korean Chem. Soc.* **2009**, *30*, 1439–1440. doi:10.5012/bkcs.2009.30.7.1439
39. Kwon, B. K.; Kim, S. M.; Kim, D. Y. *J. Fluorine Chem.* **2009**, *130*, 759–761. doi:10.1016/j.jfluchem.2009.06.002
40. Li, H.; Zu, L.; Xie, H.; Wang, W. *Synthesis* **2009**, 1525–1530. doi:10.1055/s-0028-1088124
41. Sandford, G. *J. Fluorine Chem.* **2007**, *128*, 90–104. doi:10.1016/j.jfluchem.2006.10.019
42. Chambers, R. D.; Nakano, T.; Parsons, M.; Sandford, G.; Batsanov, A. S.; Howard, J. A. K. *J. Fluorine Chem.* **2008**, *129*, 811–816. doi:10.1016/j.jfluchem.2008.04.010
43. Chambers, R. D.; Sandford, G.; Trmcic, J.; Okazoe, T. *Org. Process Res. Dev.* **2008**, *12*, 339–344. doi:10.1021/op700194r
44. Chambers, R. D.; Nakano, T.; Okazoe, T.; Sandford, G. *J. Fluorine Chem.* **2009**, *130*, 792–798. doi:10.1016/j.jfluchem.2009.06.003
45. Chambers, R. D.; Fox, M. A.; Holling, D.; Nakano, T.; Okazoe, T.; Sandford, G. *Lab Chip* **2005**, *5*, 191–198. doi:10.1039/b416400h
46. Chambers, R. D.; Fox, M. A.; Holling, D.; Nakano, T.; Okazoe, T.; Sandford, G. *Chem. Eng. Technol.* **2005**, *28*, 344–352. doi:10.1002/ceat.200407123
47. Chambers, R. D.; Fox, M. A.; Sandford, G. *Lab Chip* **2005**, *5*, 1132–1139. doi:10.1039/b504675k
48. Breen, J. R.; Sandford, G.; Yufit, D. S.; Howard, J. A. K.; Fray, J.; Patel, B. *Beilstein J. Org. Chem.* **2011**, *7*, 1048–1054. doi:10.3762/bjoc.7.120
49. McPake, C. B.; Sandford, G. *Org. Process Res. Dev.* **2012**, *16*, 844–851. doi:10.1021/op200331s
50. Hutchinson, J.; Sandford, G.; Vaughan, J. F. S. *Tetrahedron* **1998**, *54*, 2867–2876. doi:10.1016/S0040-4020(98)83023-8
51. Beare, N. A.; Hartwig, J. F. *J. Org. Chem.* **2002**, *67*, 541–555. doi:10.1021/jo016226h
52. Harsanyi, A. M.Sc. Thesis, Synthesis of 3-fluoro-oxindoles and phenyl fluoroacetic acid derivatives; Durham University, 2013, available from <http://etheses.dur.ac.uk/6357/>.
53. Shibata, N.; Suzuki, E.; Asahi, T.; Shiro, M. *J. Am. Chem. Soc.* **2001**, *123*, 7001–7009. doi:10.1021/ja010789t
54. Shibata, N.; Ishimaru, T.; Suzuki, E.; Kirk, K. L. *J. Org. Chem.* **2003**, *68*, 2494–2497. doi:10.1021/jo026792s
55. Zoute, L.; Audouard, C.; Plaquevent, J.-C.; Cahard, D. *Org. Biomol. Chem.* **2003**, *1*, 1833–1834. doi:10.1039/b303113f
56. Shibata, N.; Kohno, J.; Takai, K.; Ishimaru, T.; Nakamura, S.; Toru, T.; Kanemasa, S. *Angew. Chem., Int. Ed.* **2005**, *44*, 4204–4207. doi:10.1002/anie.200501041

57. Hamashima, Y.; Suzuki, N.; Takano, H.; Shimura, Y.; Sodeoka, M. *J. Am. Chem. Soc.* **2005**, *127*, 10164–10165. doi:10.1021/ja0513077
58. Deng, Q.-H.; Wadepohl, H.; Gade, L. H. *Chem.–Eur. J.* **2011**, *17*, 14922–14928. doi:10.1002/chem.201102375
59. Li, J.; Cai, Y.; Chen, W.; Liu, X.; Lin, L.; Feng, X. *J. Org. Chem.* **2012**, *77*, 9148–9155. doi:10.1021/jo301705t
60. Wu, L.; Falivene, L.; Drinkel, E.; Grant, S.; Linden, A.; Cavallo, L.; Dorta, R. *Angew. Chem., Int. Ed.* **2012**, *51*, 2870–2873. doi:10.1002/anie.201200206
61. Ishimaru, T.; Shibata, N.; Horikawa, T.; Yasuda, N.; Nakamura, S.; Toru, T.; Shiro, M. *Angew. Chem., Int. Ed.* **2008**, *47*, 4157–4161. doi:10.1002/anie.200800717
62. Dou, X.; Lu, Y. *Org. Biomol. Chem.* **2013**, *11*, 5217–5221. doi:10.1039/c3ob41267a
63. Hewawasam, P.; Gribkoff, V. K.; Pendri, Y.; Dworetzky, S. I.; Meanwell, N. A.; Martinez, E.; Boissard, C. G.; Post-Munson, D. J.; Trojnecki, J. T.; Yeleswaram, K.; Pajor, L. M.; Knipe, J.; Gao, Q.; Perrone, R.; Starret, J. E. *Bioorg. Med. Chem. Lett.* **2002**, *12*, 1023–1026. doi:10.1016/S0960-894X(02)00101-4
64. Schiefer, I. T.; Abdul-Hay, S.; Wang, H.; Vanni, M.; Qin, Z.; Thatcher, G. R. J. *J. Med. Chem.* **2011**, *54*, 2293–2306. doi:10.1021/jm101450p
65. Zhang, F.; Song, J. Z. *Tetrahedron Lett.* **2006**, *47*, 7641–7644. doi:10.1016/j.tetlet.2006.08.057
66. Rozen, S.; Hagooly, A.; Harduf, R. *J. Org. Chem.* **2001**, *66*, 7464–7468. doi:10.1021/jo010677k
67. Davis, F. A.; Han, W.; Murphy, C. K. *J. Org. Chem.* **1996**, *60*, 4730–4737. doi:10.1021/jo00120a014
68. Cantrell, G. L.; Filler, R. *J. Fluorine Chem.* **1985**, *27*, 35–45. doi:10.1016/S0022-1139(00)80895-7
69. Bresciani, S.; O'Hagan, D. *Tetrahedron Lett.* **2010**, *51*, 5795–5797. doi:10.1016/j.tetlet.2010.08.104
70. Watanabe, S.; Fujita, T.; Sakamoto, M.; Endo, H.; Kitazume, T. *J. Fluorine Chem.* **1990**, *47*, 187–192. doi:10.1016/S0022-1139(00)82371-4
71. Kim, K.-Y.; Kim, B. C.; Lee, H. B.; Shin, H. *J. Org. Chem.* **2008**, *73*, 8106–8108. doi:10.1021/jo8015659
72. Yin, J.; Zarkowsky, D. S.; Thomas, D. W.; Zhao, M. M.; Huffman, M. A. *Org. Lett.* **2004**, *6*, 1465–1468. doi:10.1021/ol049672a

License and Terms

This is an Open Access article under the terms of the Creative Commons Attribution License (<http://creativecommons.org/licenses/by/2.0>), which permits unrestricted use, distribution, and reproduction in any medium, provided the original work is properly cited.

The license is subject to the *Beilstein Journal of Organic Chemistry* terms and conditions: (<http://www.beilstein-journals.org/bjoc>)

The definitive version of this article is the electronic one which can be found at:
doi:10.3762/bjoc.10.119